



PROTERRA

PROTERRA

ZX5 40 DuoPower Emergency Response Guide







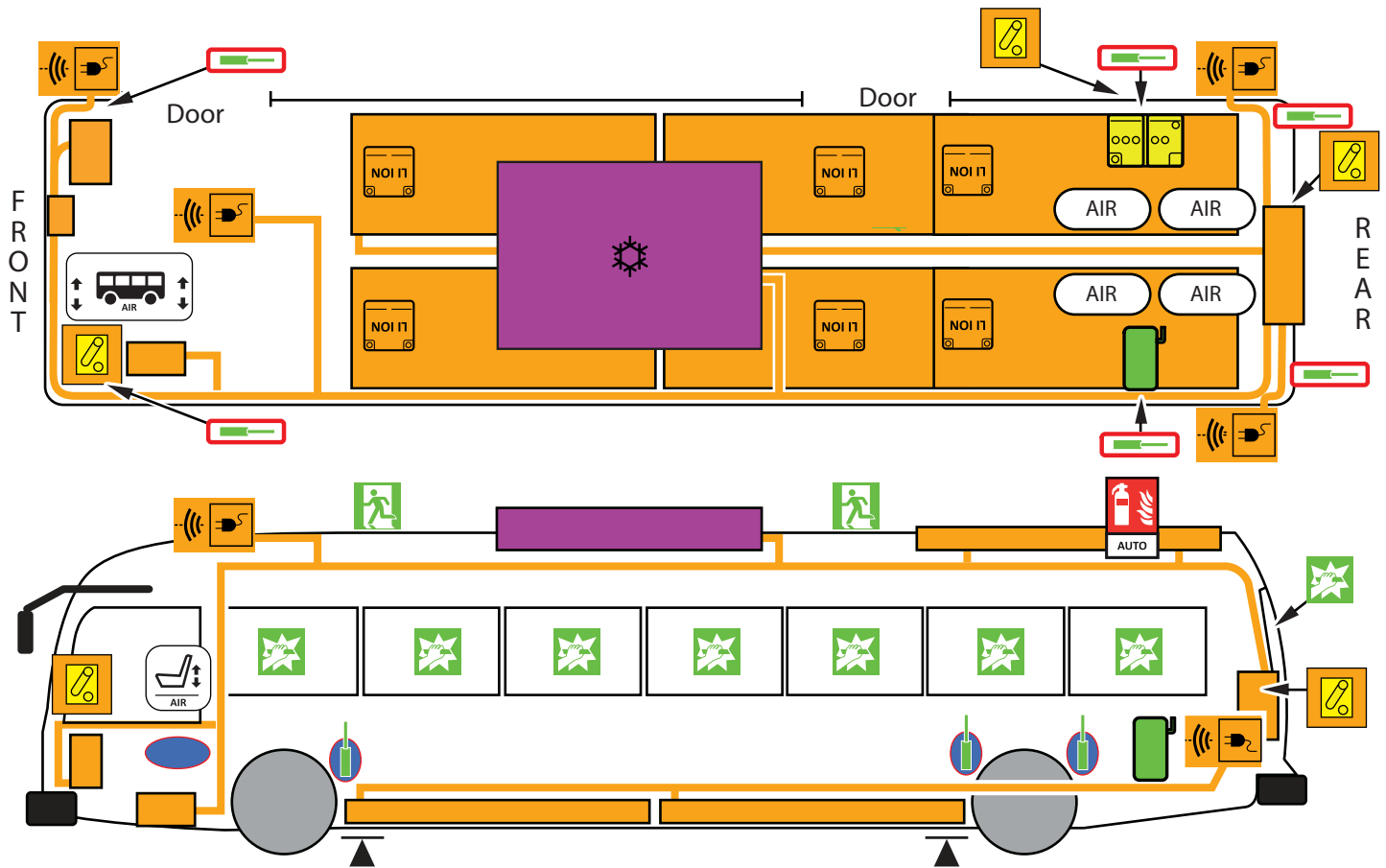

0. Rescue Sheets

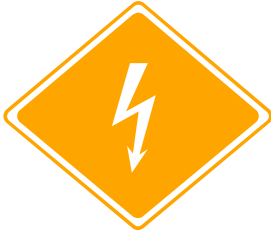

Proterra
ZX5 40 DuoPower
2020 -

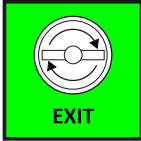

Electric Propulsion	Induction Charging	High Voltage Li-ion Battery	High Voltage Component	High Voltage Power	Disconnect High Voltage	Air Tank
Low Voltage Battery	Emergency Exit	Break To Obtain Access	Emergency Door Opener	Seat Adjustment	Air Conditioning	Automatic Fire Suppression
Airbag	Lifting Point	Height Control	Preloaded Spring	Gas Strut	Fuel Tank	

1. Identification / Recognition	
	<p>Electric bus with inductive charging</p>
2. Immobilization / Stabilization / Lifting	
	<p>Height control bus in drivers cabin</p>
	<p>Seat height adjustment in drivers cabin</p>
	<p>Use only these lifting points</p>
3. Disable Direct Hazards / Safety Regulations	
	<p>Shut Down high voltage at three places</p>
4. Access To The Occupants	
	<p>Two door exits</p>
	<p>Two Roof exits</p>
	<p>Break these windows to obtain access</p>

5. Stored energy / Liquids / Gases / Solids

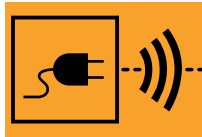

Induction power field



6. In Case Of Fire



7. In Case Of Submersion



Follow heading 3. Disable direct hazards / safety regulations once out of the water

8. Towing / Transportation / Storage



Check battery temperature



PROTERRA

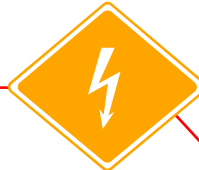

2. Immobilization / Stabilization / Lifting



Ride Height Adjustment

The Ride height control is located on the dash console in the drivers workplace. This control can be used as needed to raise or lower the bus by inflating and deflating airbags connected to the front and rear suspension. Lowering the bus will decrease the stored energy in the airbags and may reduce safety hazards to first responders.



Seat Adjustment

The driver's seat also contains stored energy in inflated air bags. The controls are located on the right side of the seat and may be useful to make rescue easier.



1 2 3 4 5 6

1....Seat back angle adjustment (rotate cw or ccw)

4....Seat height adjustment (pneumatic adjust only)

2....Lumbar support adjustments (inward or outward)

5....Seat fore/aft mechanical lock

3....Seat fore/aft air lock (pneumatic adjust only)

6....Thigh support lock (each side of seat)

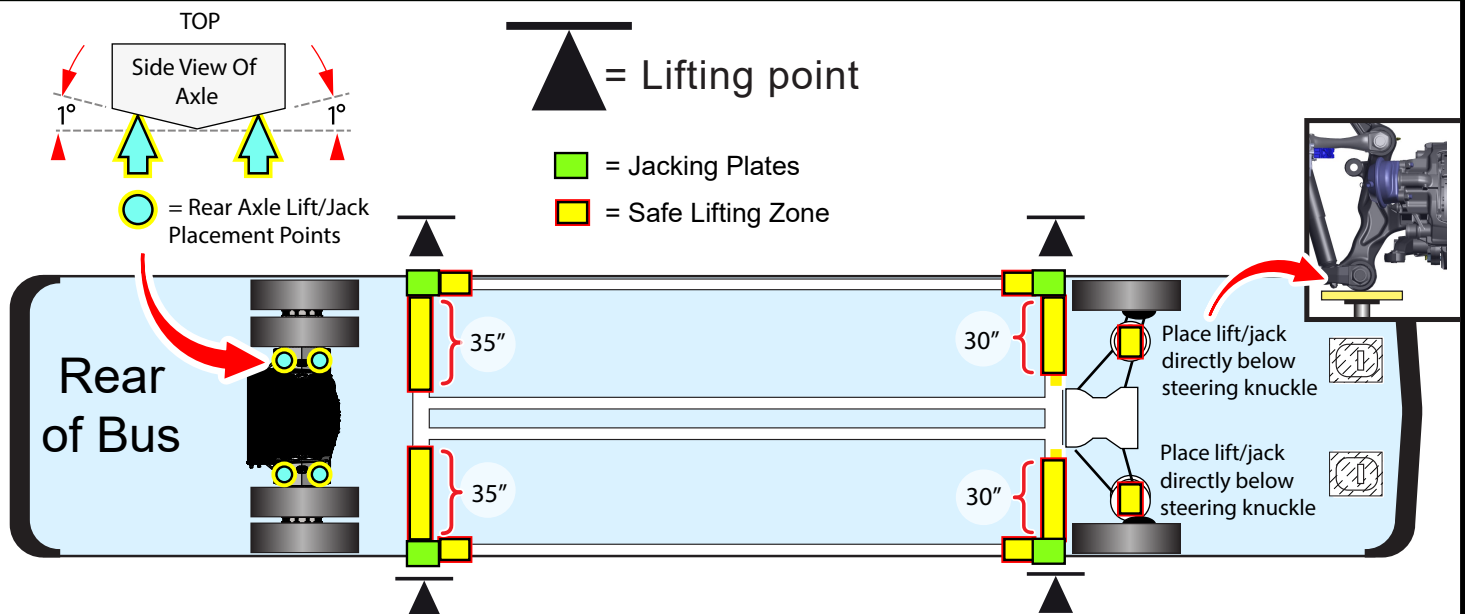

3. Disable Direct Hazards / Safety Regulations



Shut down high voltage at three places

Turn Master Switch to "OFF".

Located in drivers workplace.

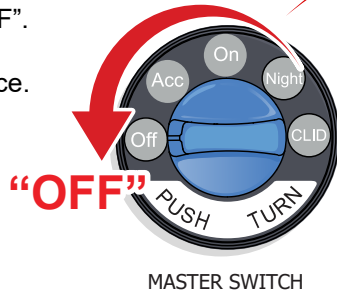

Turn Vehicle Master Disconnect counter-clockwise To "OFF".

Located at curbside rear upper access panel.

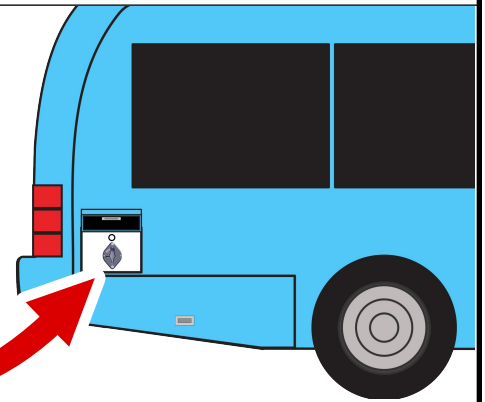

Allow 2 minutes for the high-voltage system to de-energize after disabling the Master Switch and Vehicle Master Disconnect .

Turn High Voltage Junction Box Disconnect Switch to the "OFF" position.

Located inside the Rear Access Panel (Trunk) on the curbside of the High Voltage Junction Box.

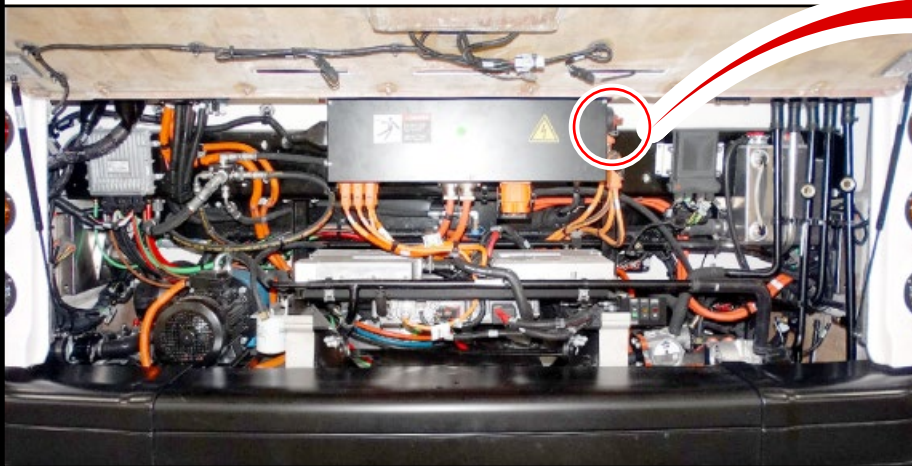

4. Access To The Occupants

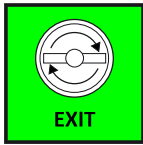

Two door exits located beside each door inside the bus:

- A. Break the cover.
- B. Turn the knob
- C. Force the doors open manually by pulling apart from center.



Door Release Knobs

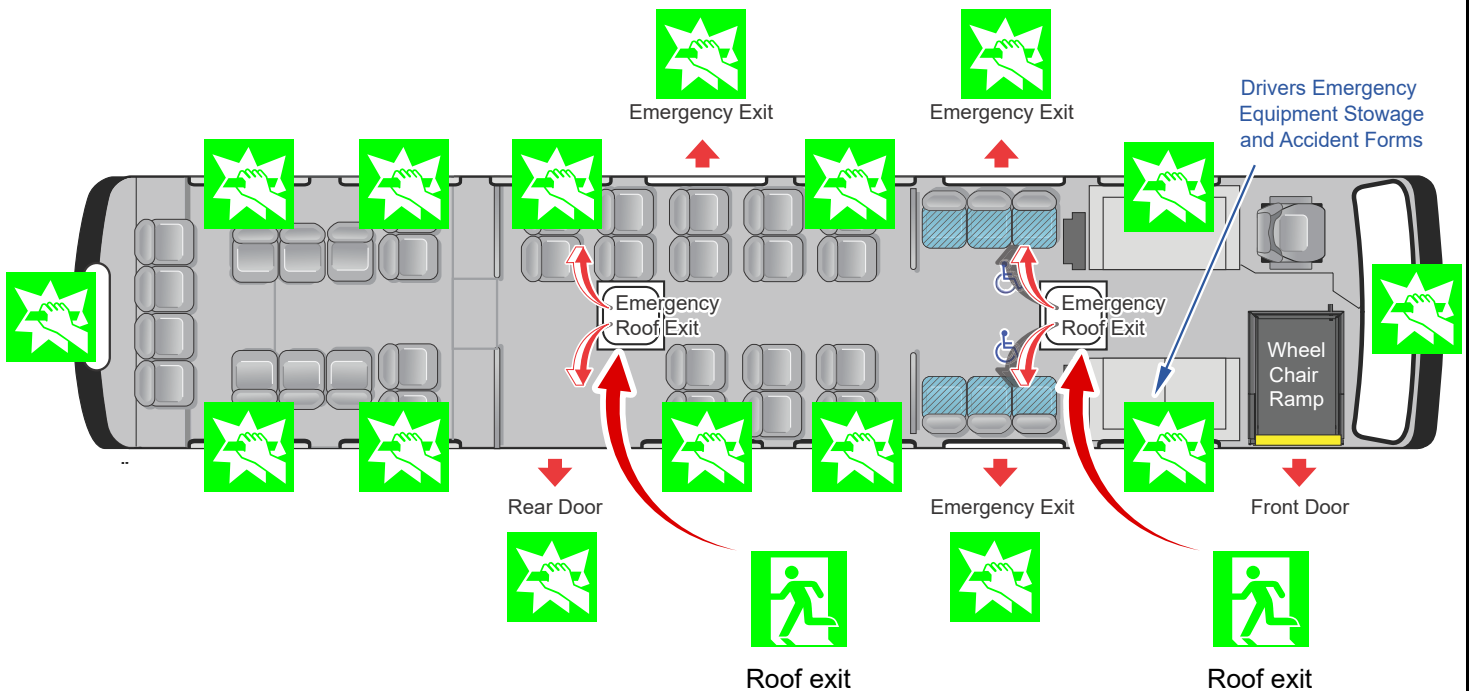

Emergency Exit windows may be placed in additional or alternate locations per customer request.

4. Access To The Occupants

Roof Exit Hatch From Inside

Turn to right or left
and
push up.



Passenger Window Emergency Release Lever



1. Pull Emergency
Release Handle
Down to Unlock

2. Push Out From the
Bottom to Open
Passenger
Window



5. Stored Energy / Liquids / Gases / Solids

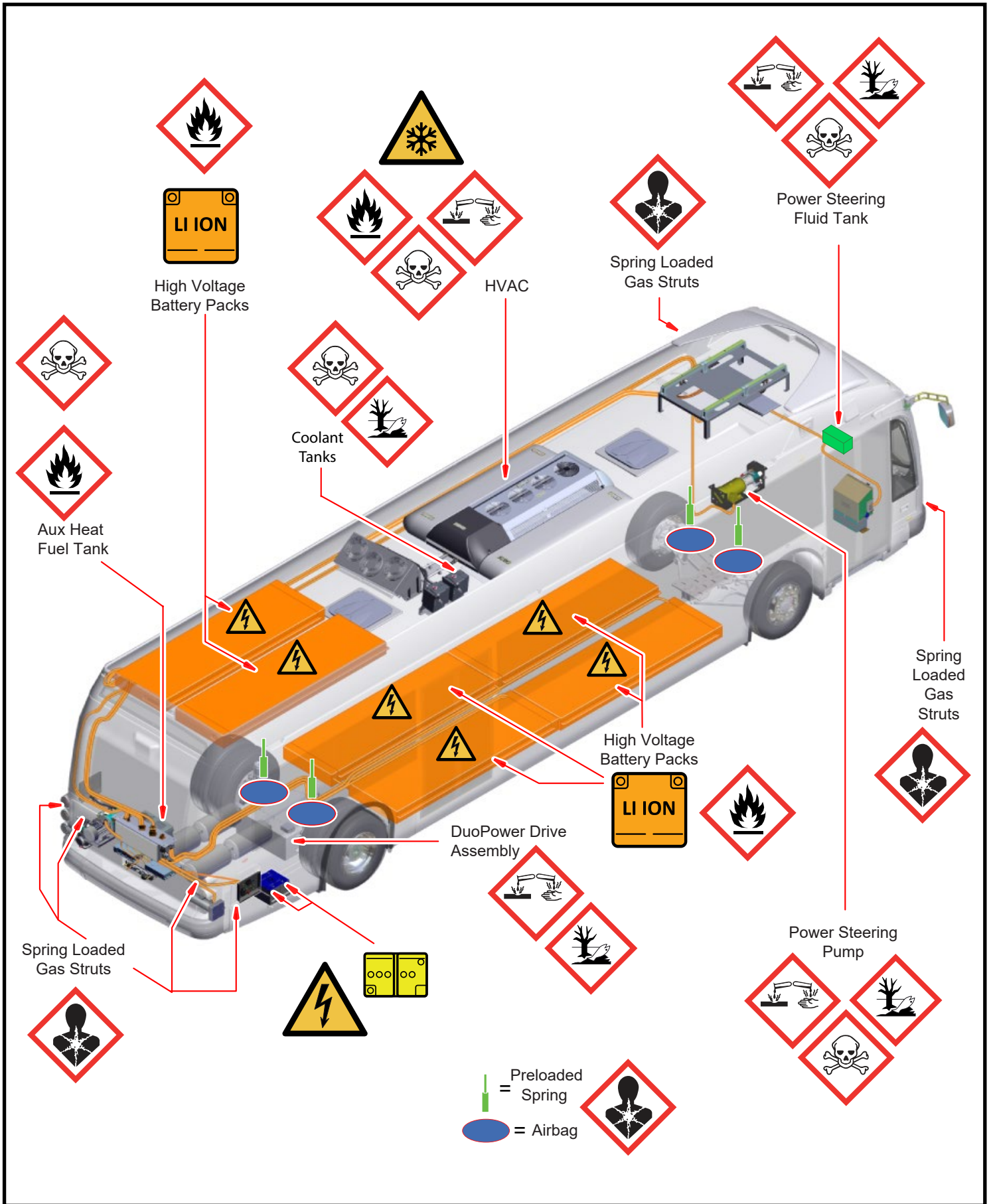

6. In Case Of Fire

If a fire develops, the Incident Commander should determine whether an attempt will be made to suppress the fire (aggressive firefighting) or allow the battery pack to burn until it self extinguishes, while protecting surrounding materials (defensive firefighting). Establish a 20 foot radius “safety zone” around the vehicle.

Virtually all fires involving lithium-ion batteries can be controlled with water. To date, water has been found to be the most effective agent for controlling lithium-ion battery fires. Water will suppress flames and can cool cells, limiting propagation of thermal runaway reactions. If water is used, electrolysis of water (splitting of water into hydrogen and oxygen) may contribute to the flammable gas mixture formed by venting cells, burning plastic, and burning of other combustibles. Thus copious volumes of water should be used to fight a lithium-ion battery fire.

Gaseous agents such as CO₂ or Halon, or dry chemical suppressants may temporarily suppress flaming of lithium-ion battery packs, but they will not cool lithium-ion batteries and will not limit the propagation of cell thermal runaway reactions. Metal fire suppressants such as LITH-X, graphite powder, or copper powder are not appropriate agents for suppressing fires involving lithium-ion battery packs as they are unlikely to be effective.

A battery fire may continue for several hours and it may take 24 hours or longer for the battery pack to cool. A lithium-ion battery fire that has been extinguished can re-ignite due to the exothermic reaction of constituent materials from broken or damaged cells. To avoid this, remove sources of ignition and cool the burned mass by flooding with water.



When fire is present, always wear appropriate PPE, including self - contained breathing apparatus.

NOTE: Direct hose streams toward the outside edge of the battery packs as shown in the diagram below. Apply copious amounts of water.

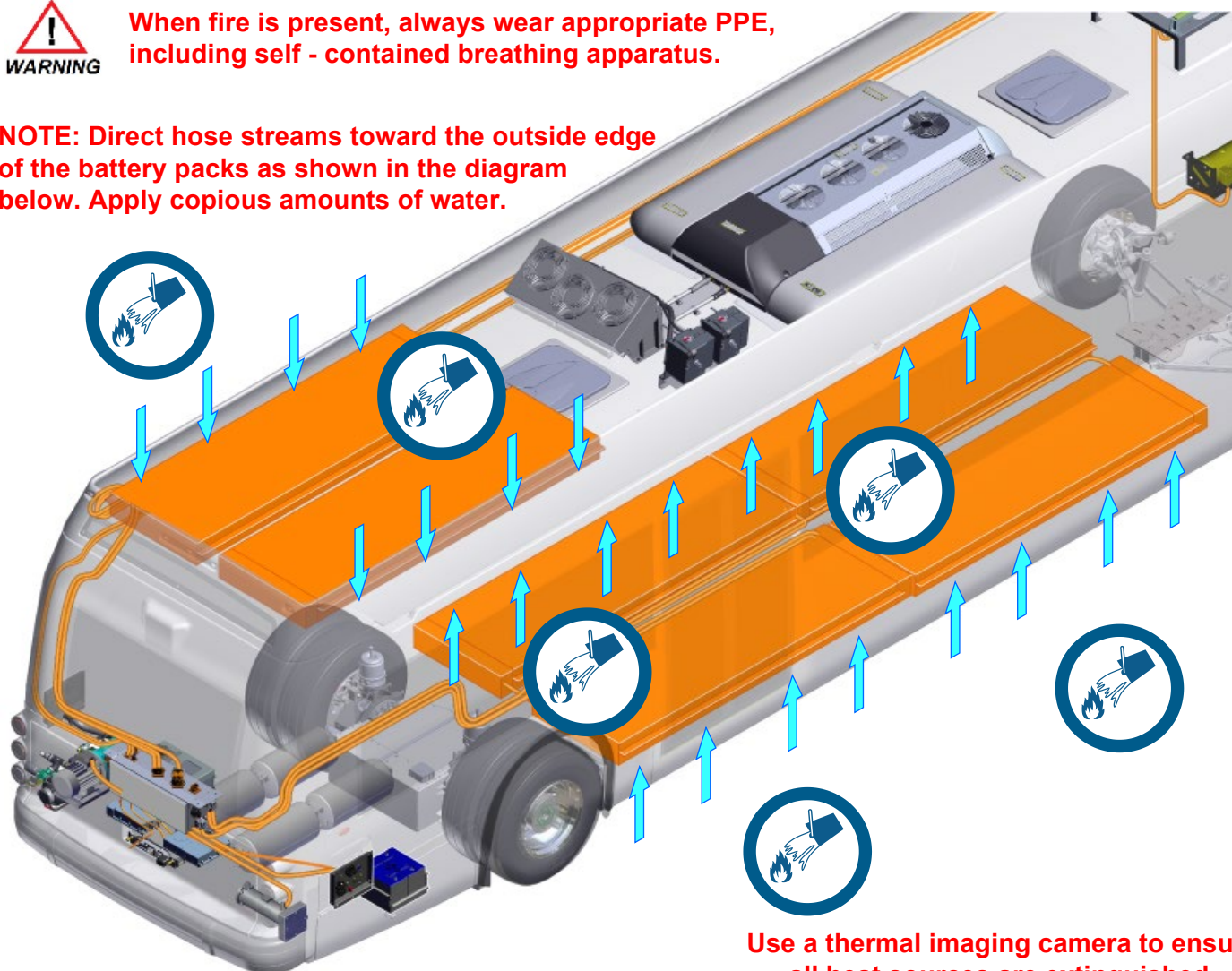

Use a thermal imaging camera to ensure all heat sources are extinguished.

7. In Case Of Submersion

Turn Vehicle Master Disconnect Counter-Clockwise to "OFF".

Located at curbside rear upper access panel.



Vehicle Master Disconnect

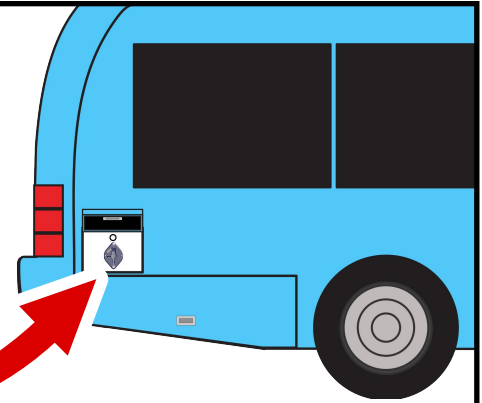

Turn Master Switch to "OFF".

Located in drivers workplace.



Turn High Voltage Junction Box Disconnect Switch to the "OFF" position.

Located inside the Rear Access Panel (Trunk) on the right side (curbside) of the High Voltage Junction Box.

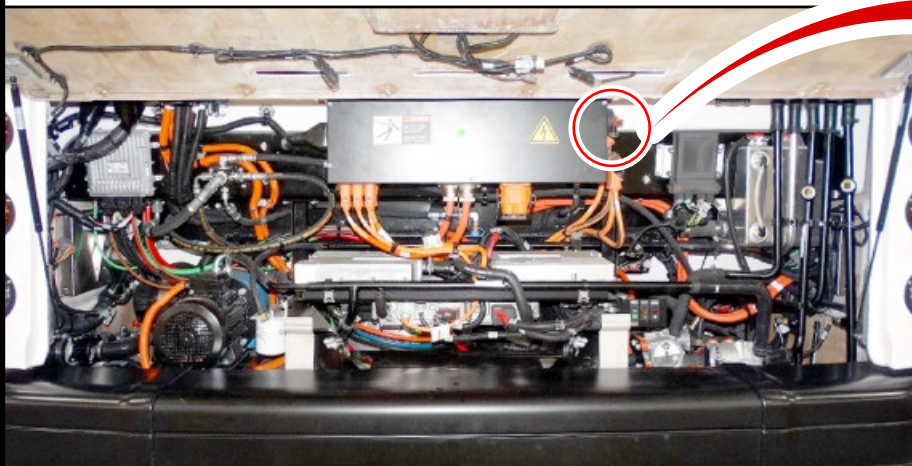

8. Towing / Transportation / Storage

Condition 1

The bus has HV power and operational air compressor.

Turn Vehicle Master Disconnect to "ON"

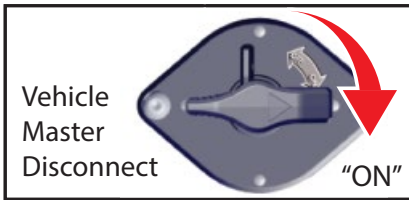

Turn Master Switch "ON". (If Compressor does not start proceed to "Condition 2".)

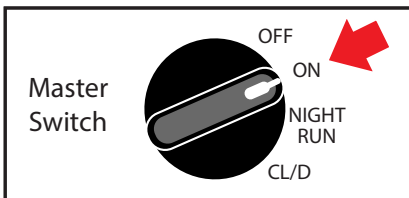

Wait 4 minutes to establish air pressure. (If the compressor does not cut off within 4 minutes, proceed to "Condition 3".)

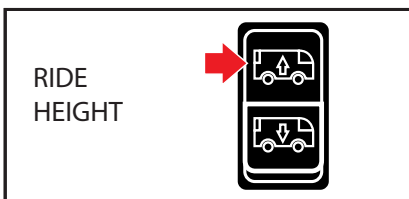

Maximize Ride Height.

Remove the cover from the VEC on rear deck. According to the label on the VEC cover, identify and pull the circuit breaker associated with the ride height system.



To use bus lights leave Master Switch "ON" and engage the Interlock Override.

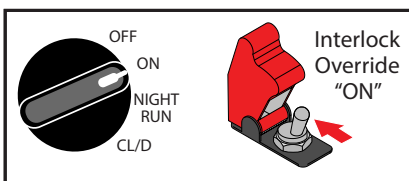

Press brake pedal and push the Parking Brake Release Handle.

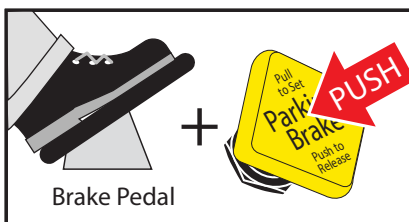

Condition 2

No HV power or air compressor inoperable.

Remove the cover from the VEC on rear deck. According to the label on the VEC cover, identify and pull the circuit breaker associated with the ride height system.



Manually fill individual air bags to raise ride height. (Located behind the street side rear access panel.)

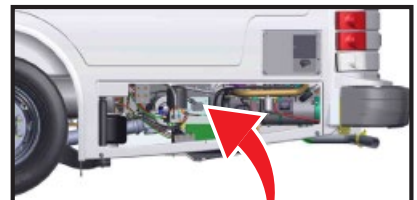

Manually fill the air tanks or connect tow vehicle air at front bumper.

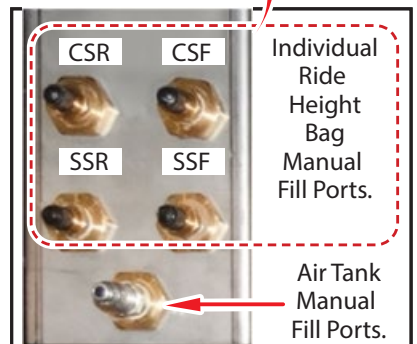

Ensure that system has no major air leaks. (If major leak is detected proceed to "Condition 3".)

Turn Vehicle Master Disconnect to "OFF".

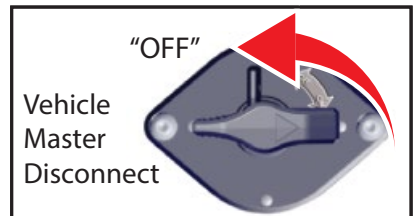

Press brake pedal and push the Parking Brake Release Handle.

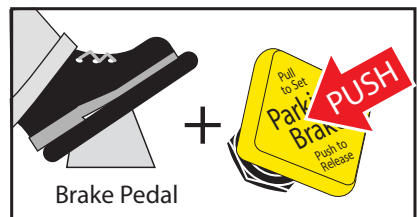

Do not tow at speeds exceeding 65 MPH in any condition.

Do not tow continuously for more than 1 hour in any condition.

8. Towing / Transportation / Storage

Condition 3

Air system unable to maintain air pressure.

Remove the cover from the VEC on rear deck. According to the label on the VEC cover, identify and pull the circuit breaker associated with the ride height system



Manually fill individual air bags to raise ride height. (Located behind the street side rear access panel.)



Do not tow at speeds exceeding 65 MPH in any condition.

Do not tow continuously for more than 1 hour in any condition.

Cage the brakes.

See "Caging Brakes" on reverse side.

If using bus lights leave Master Switch "ON" and engage the Interlock Override.

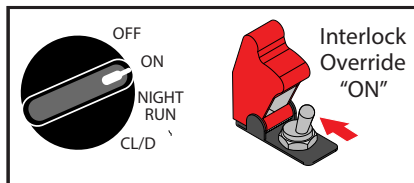

If HV power is unavailable, turn Vehicle Master Disconnect to "OFF".

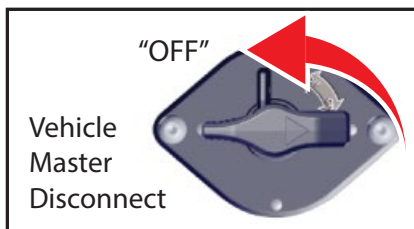

Caging the Brakes

In order to cage or disengage the rear brakes, you must remove the rear brake canister access plug on each rear wheel well.

NOTE: You may need to remove seats to access this plug.

Loosen the nut or allen screw in the center of the plug to allow for removal.

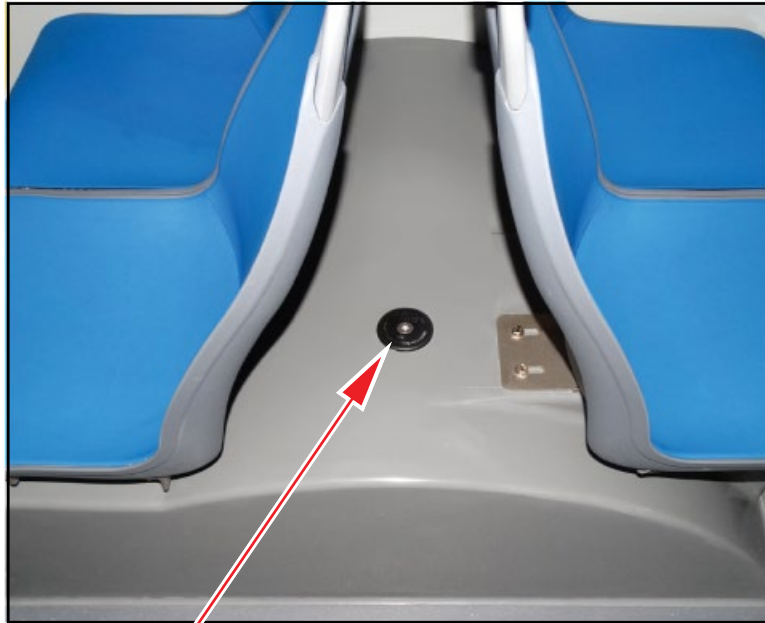

Rear Brake
Canister
Access Plug

Using a ratchet with an extension, turn the brake caging bolt counter-clockwise to disengage the rear brake. Repeat for both sides.

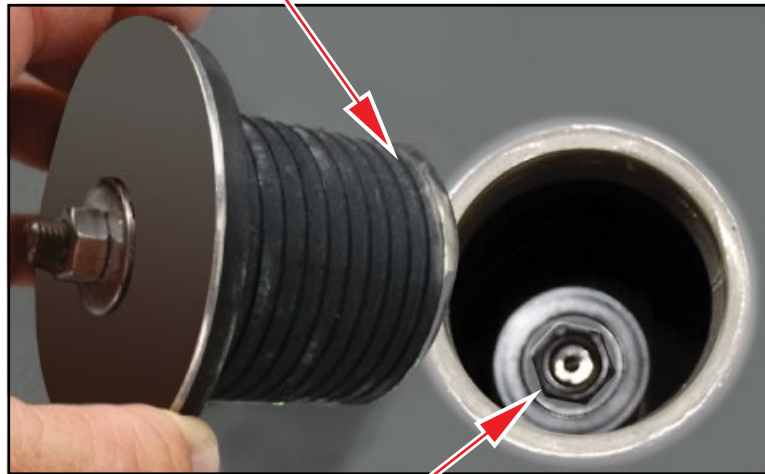

8. Towing / Transportation / Storage

Rear Extraction

The rear extraction points on the ProDrive frame are located behind the rear bumper under the rear trunk lid. They provide a strong and secure point to help stabilize the bus at an emergency scene.

The ProDrive Frame also has lower rear securement points.

Note: If the bus has belly pans (not shown) chaining will require a 1" throat-type hook.

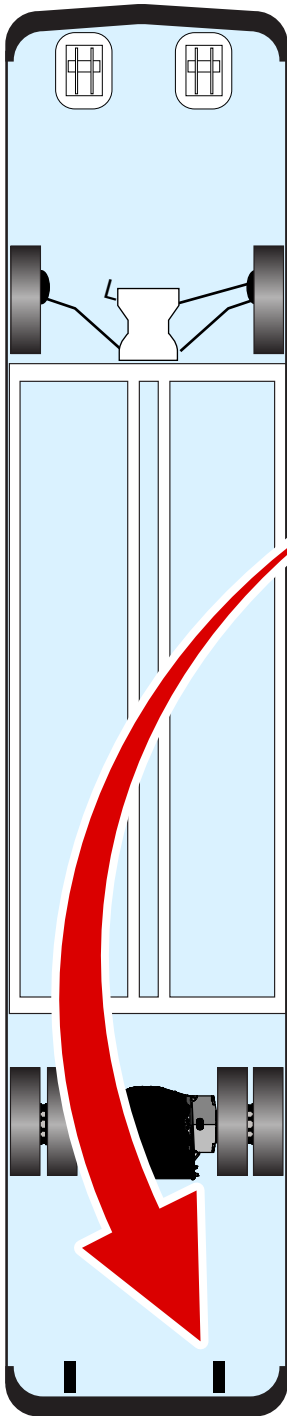

Rear
of Bus



Front Extraction

The front tow pockets are located behind and below the front bumper.

They provide a strong and secure point to help stabilize the bus at an emergency scene.

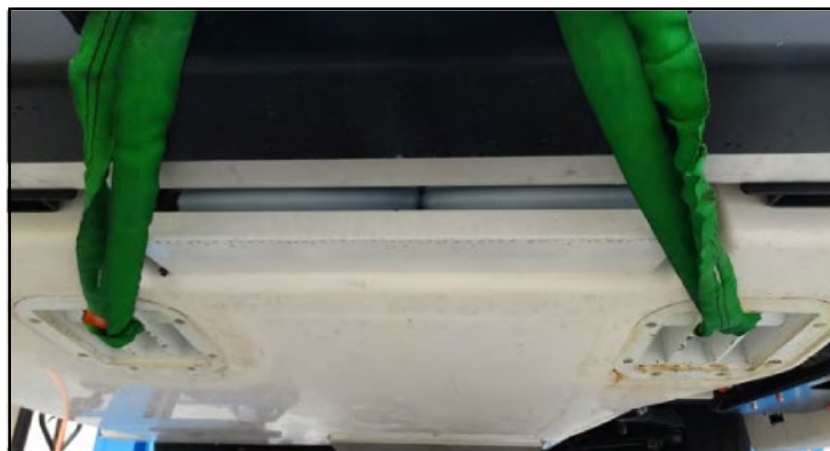
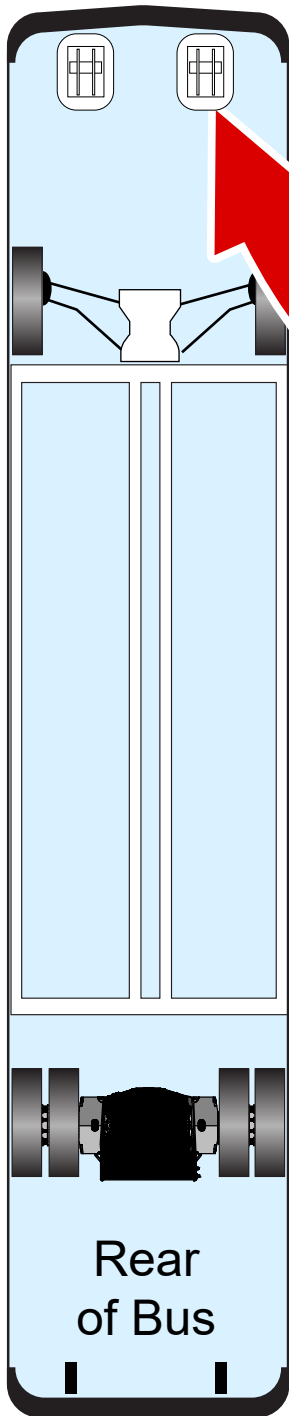

8. Towing / Transportation / Storage

1. Locate the tow truck to access the front of the vehicle.



2. The tow truck driver then lowers the stinger, positions it for lifting the front of



3. Reposition the lifting forks to align with the front tow pockets.



4. Carefully raise the stinger to mate the tow forks with the tow pockets and lift the front of the bus off the ground.



8. Towing / Transportation / Storage

5. Wrap safety chains around each towing attachment point and secure.



6. Install Safety Straps/Safety Chains between the tow pockets of the bus and the tow vehicle.



DO NOT flat tow the bus (drive wheels on the ground) for over 1 hour or at speeds exceeding 65 MPH in any condition or vehicle damage may occur. Ensure the bus is in Neutral, by either turning the bus OFF or verifying “N” button illuminated on left console.

7. Connect the tow vehicle wiring harness to the front of the bus to allow operation of the bus brake lights and turn signals.



8. Tow or winch normally according to the appropriate Bus Towing Process (Power or No Power).

8. Towing / Transportation / Storage

Damaged Battery Storage

If a Proterra battery pack has been damaged (enclosure integrity has been compromised), it is possible that heating is occurring that may eventually lead to a fire. Damaged or opened cells/batteries can result in rapid heating (due to exothermic reaction of constituent materials), the release of flammable vapors, and propagation or self-heating and thermal runaway reactions to neighboring cells.

Before handling or transporting a damaged battery pack, wait at least 1 hour. Smoke may be an indication that a thermal reaction is in progress. If no smoke, flame, leakage of electrolyte, leakage of coolant, or signs of heat has been observed for 1 hour, the battery pack may be disconnected and moved to a safe location.

Establish a 20 foot radius "safety zone" around the vehicle.

Use a thermal imaging camera to ensure all heat sources are extinguished.