

Rescue cards for Passenger cars

Mercedes-Benz • AMG • McLaren • Maybach • smart



Mercedes-Benz



Mercedes-Benz

Preface

Dear Reader,

One of Mercedes-Benz's main priorities has traditionally been to guarantee the highest possible standards of safety.

A comprehensive safety concept extends to providing rescue crews with specific information about our vehicles and their safety systems.

The top priority of the rescue crew is to save lives. The rescue team must be able to gain access to the accident victims as quickly as possible without exposing them or themselves to additional danger.

In order to do this, the rescue services must be properly trained. In addition, knowledge of vehicle-specific accessibility options and of the function and operation of the safety systems is absolutely essential.

In addition to its ***“Guidelines for Rescue Services”***, Mercedes-Benz now produces ***“rescue cards”*** providing information in condensed form for many model series and models **dating from the start of production in 1971** (from 1995 for campers).

Vehicle owners and emergency services can download the rescue cards from the internet free of charge.

The rescue cards are produced in full color. This helps you understand and take in the content quickly. For this reason, we strongly recommend that you ***print the cards in color***.

Daimler AG

Technical Information and Workshop Equipment (GSP/OR)

Note

The body reinforcements marked on the rescue card generally identify those areas of the vehicle which require significantly greater effort to cut using standard tools. The references to body reinforcements are therefore restricted to those areas where cutting may be necessary in order to rescue the victims, and of which the crew chief should be aware.

© 2012 by Daimler AG

This document, including all its parts, is protected by copyright.

Any commercial processing or use requires the previous written consent of Daimler AG, Department GSP/ORS, HPC R822, W002, D-70546 Stuttgart, Germany.

This applies in particular to reproduction, distribution, alteration, translation, microfilming and storage and/or processing in electronic systems, including databases and online services.

How do I find the correct rescue card?

Models and variants

Each Mercedes-Benz rescue card is applicable for one model series.

Model variants within a model series (e.g. gasoline or diesel engine) are identifiable on the rescue card by means of appropriate item numbers in the illustrations and the corresponding legends.

Occupant protection systems

The type and number of airbags, emergency tensioning retractors etc. in the vehicle is not evident from the vehicle's model or variant designation.

The occupant protection systems are therefore illustrated with the maximum possible equipment. This gives rescue crews an overview of where occupant protection systems might be installed in the vehicle.

Determining the vehicle model from the vehicle ident. no.

Identification plate on the vehicle:

Please refer to the operator's manual to find out where the identification plate is located in your vehicle.

Example of vehicle ident. no. (see illustration on the right)

WDD2120xx1Axxxxxx

In this example the vehicle is a model 212; the 0 identifies it as a sedan.

Your vehicle can be additionally identified by means of the year of manufacture and by the vehicle illustrations on the rescue card.

The relevant rescue card can therefore be found under Sedan - Model 212



Identification plate, example of an E-Class sedan, model 212

- A The first 3 letters and numbers are the world manufacturer code
- B Digits 4 to 6 indicate the vehicle model
- C Digit 7 indicates the body type

Body types:







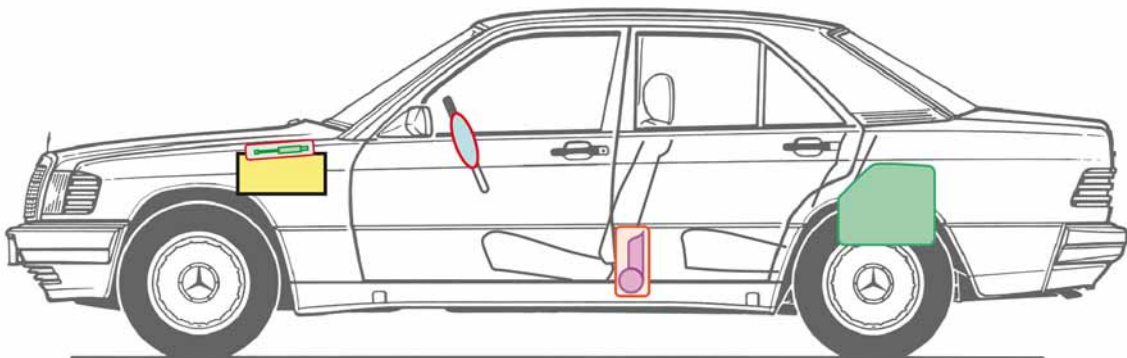
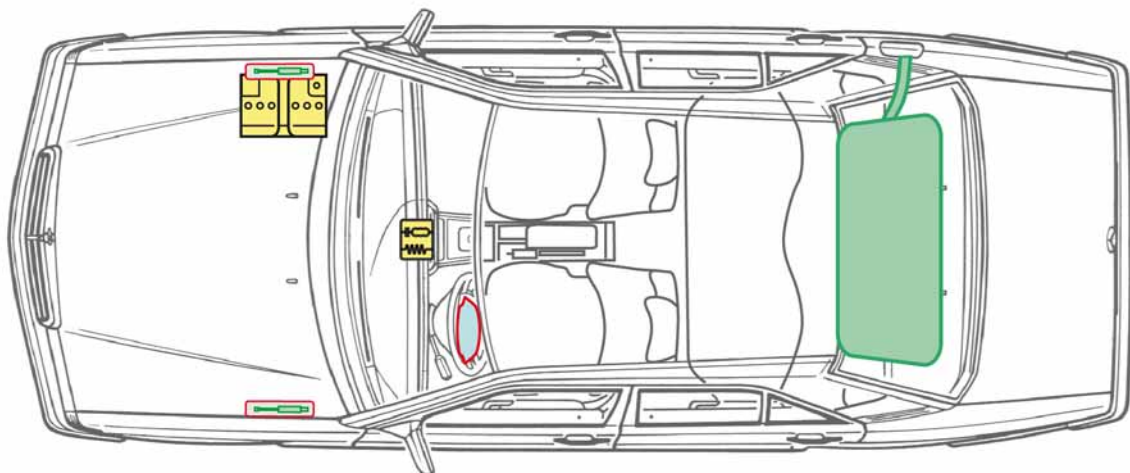

- 0 Sedan
- 1 Long sedan
- 2 Station wagon
- 3 Coupé
- 4 Convertible/roadster
- 9 Special editions (e.g. GLK)

**190
Sedan
Model 201**

1982-1993

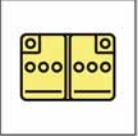

Legend

	Airbag		Structural reinforcements		Control unit
	Gas generator		Rollover protection		Battery
	Seat belt tensioner		Gas filled spring device		Fuel tank

**A-Class
Sedan**





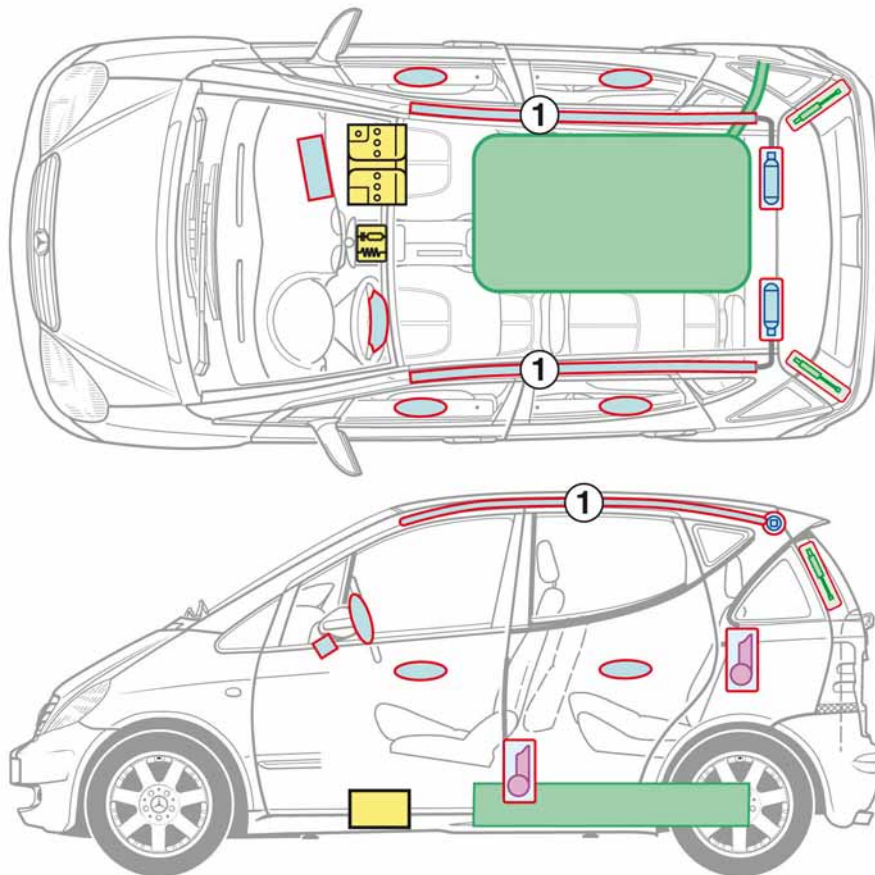

Model 168

1997-2004

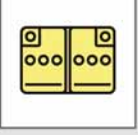
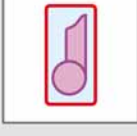
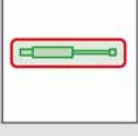

1 as of 2001

Legend

	Airbag		Structural reinforcements		Control unit
	Gas generator		Rollover protection		Battery
	Seat belt tensioner		Gas filled spring device		Fuel tank





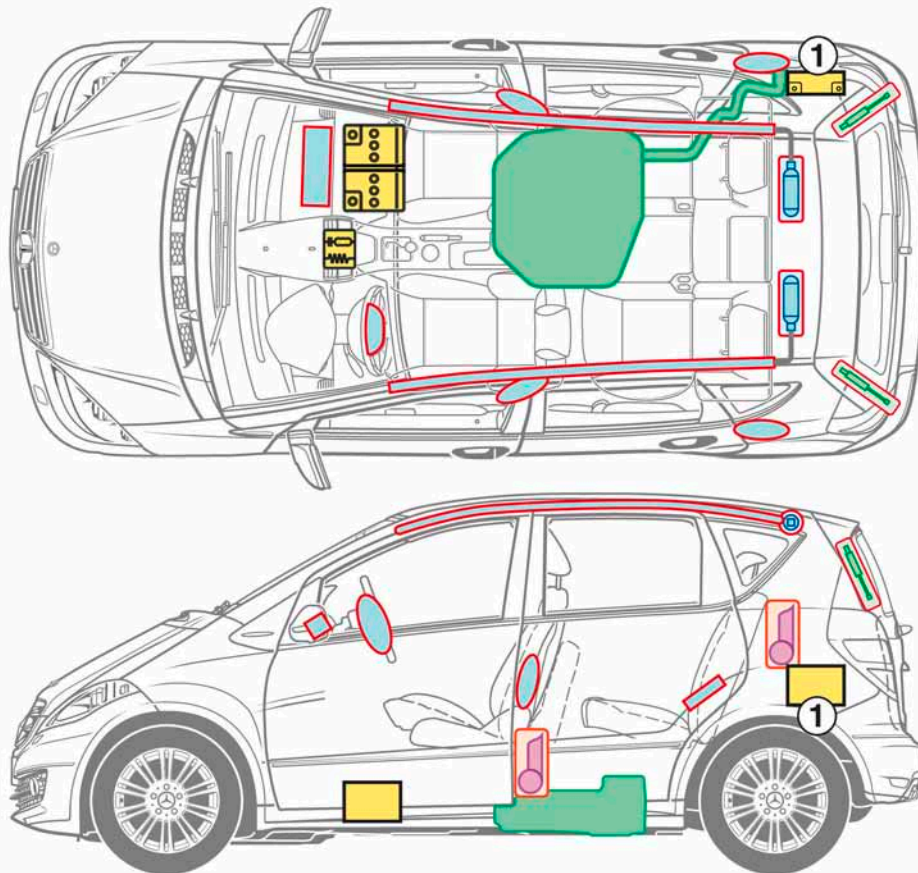

**A-Class
Sedan
Model 169**

as of 2004

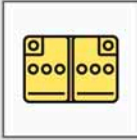
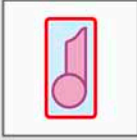

1 Additional battery BlueEFFICIENCY models

Legend

	Airbag		Structural reinforcements		Control unit
	Gas generator		Rollover protection		Battery
	Seat belt tensioner		Gas filled spring device		Fuel tank





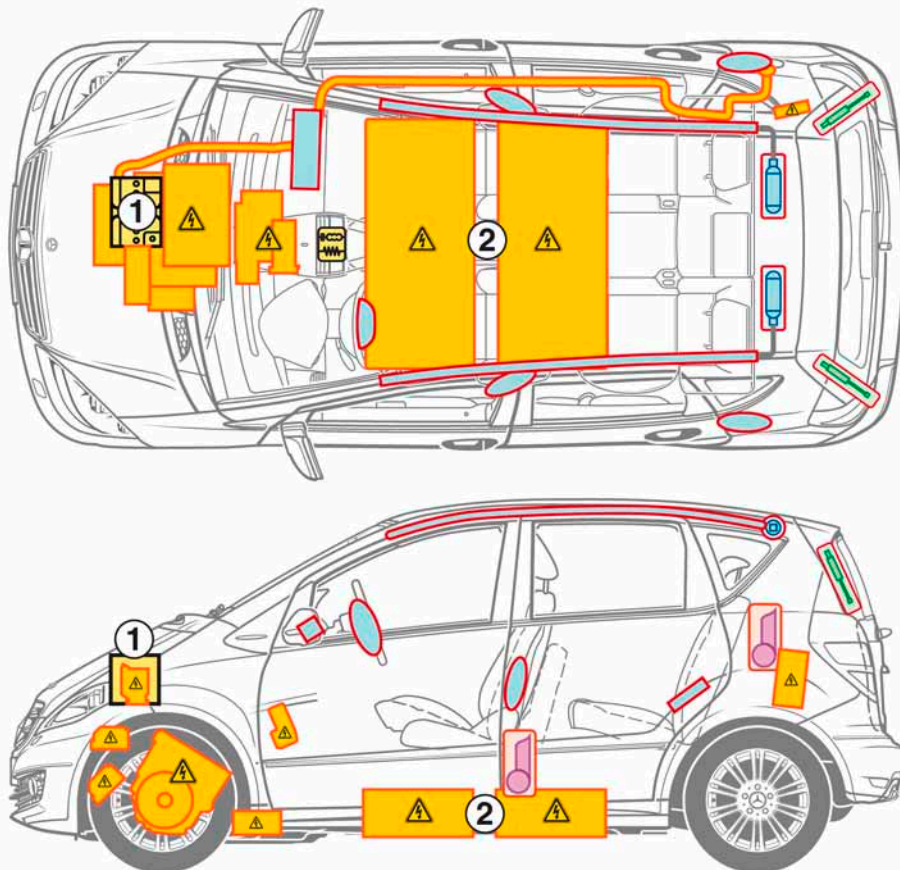

**A-Class
E-Cell
Sedan
Model 169**

as of 2010

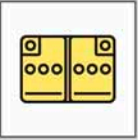
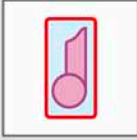

- 1 12 V-battery
- 2 High-voltage battery

Legend

	Airbag		Structural reinforcements		Control unit
	Gas generator		Rollover protection		Battery
	Seat belt tensioner		Gas filled spring device		High-voltage components





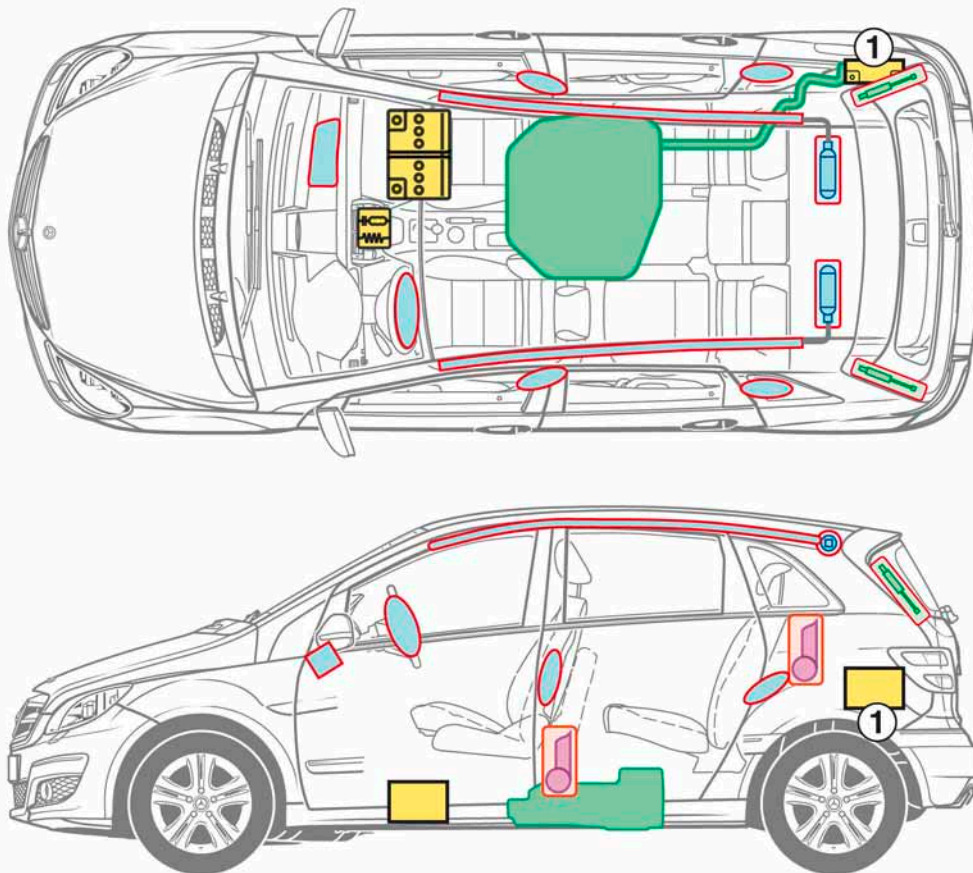

**B-Class
Sedan
Model 245**

2005-2011

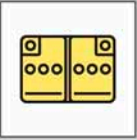
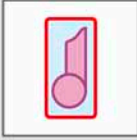

1 Additional battery BlueEFFICIENCY models

Legend

	Airbag		Structural reinforcements		Control unit
	Gas generator		Rollover protection		Battery
	Seat belt tensioner		Gas filled spring device		Fuel tank

**B-Class
NGT
Sedan
Model 245**



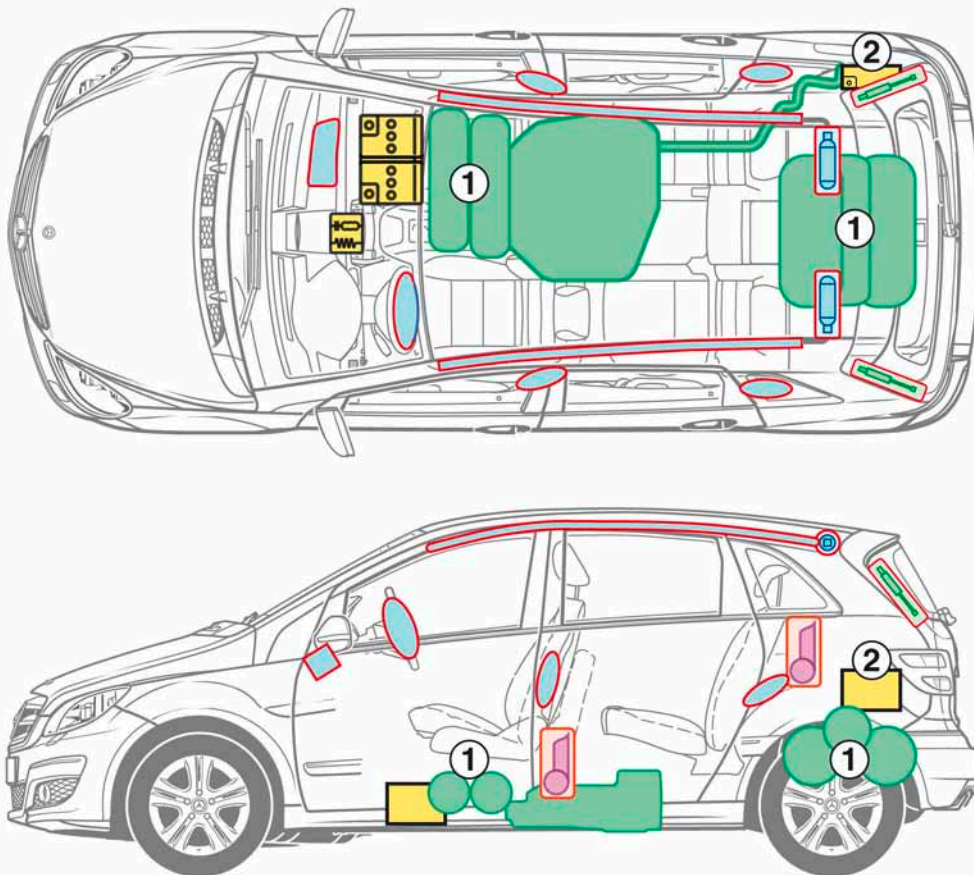



as of 2005



1 Gas cylinder

2 Additional battery BlueEFFICIENCY models

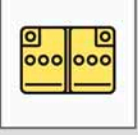
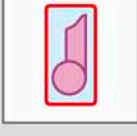
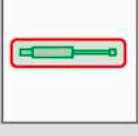
Legend

	Airbag		Structural reinforcements		Control unit
	Gas generator		Rollover protection		Battery
	Seat belt tensioner		Gas filled spring device		Fuel tank

B-Class
F-Cell
 Fuel Cell
 drive system
Model 245
 as of 2010

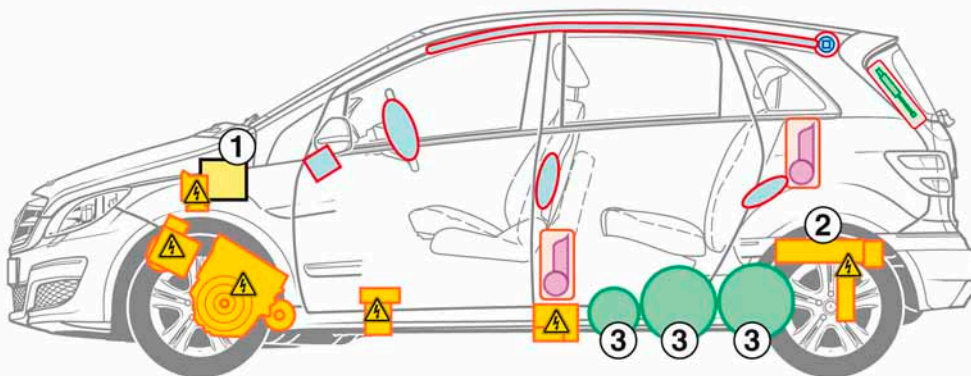
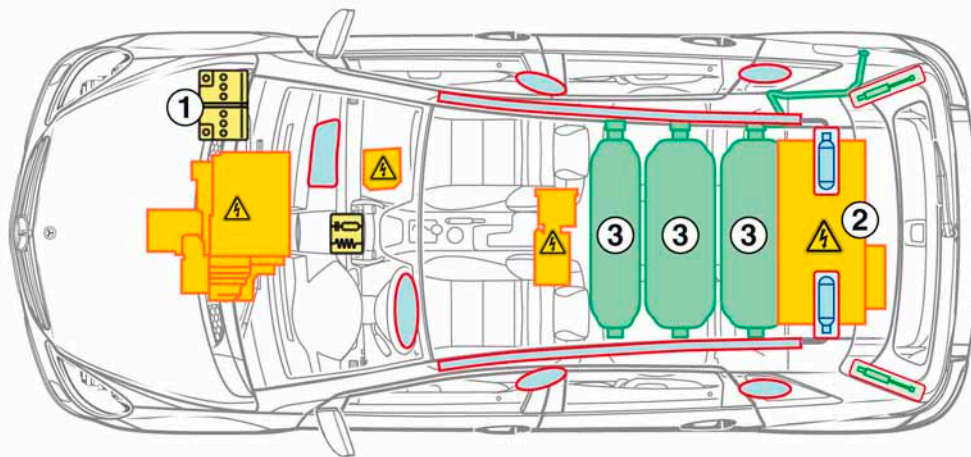







1 12 V-battery

2 High-voltage battery

3 Hydrogen cylinder

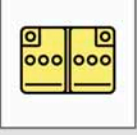
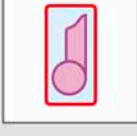
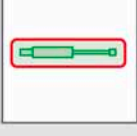
Legend

	Airbag		Structural reinforcements		Control unit
	Gas generator		High-voltage components		Battery
	Seat belt tensioner		Gas filled spring device		Fuel tank





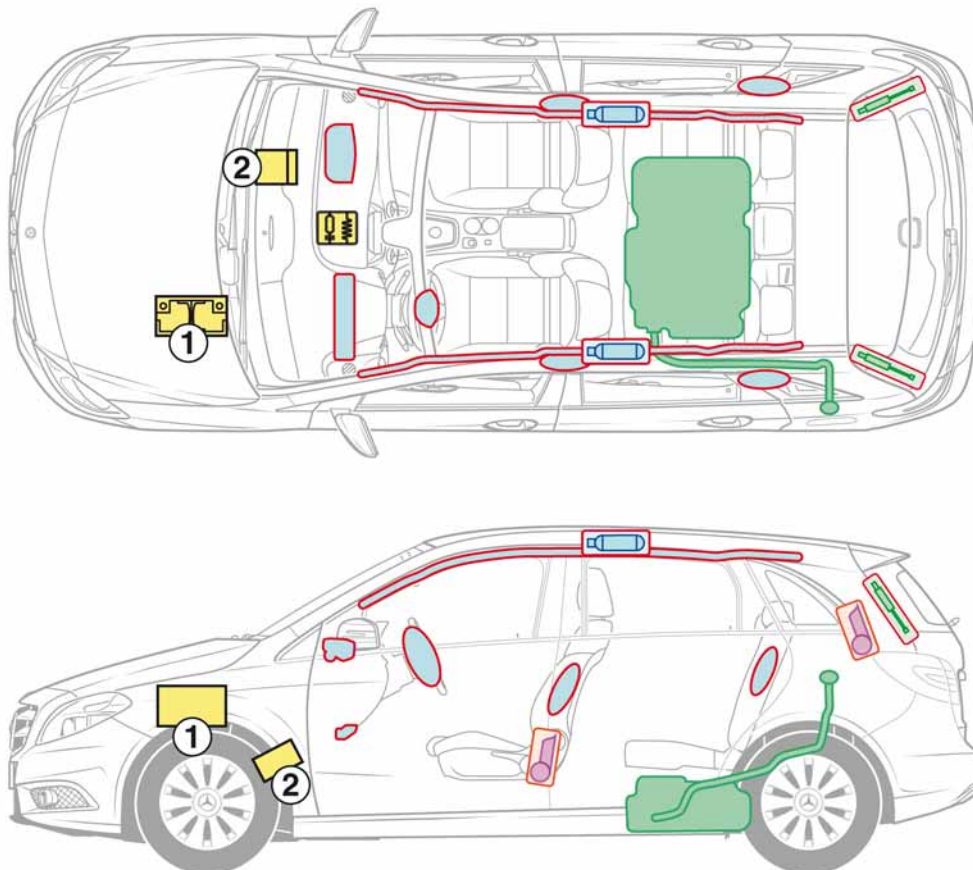



**B-Class
Sedan
Model 246**

as of 2011

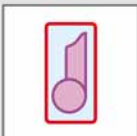
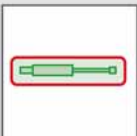

- 1 Power supply battery
- 2 Additional battery ECO Start-Stop

Legend







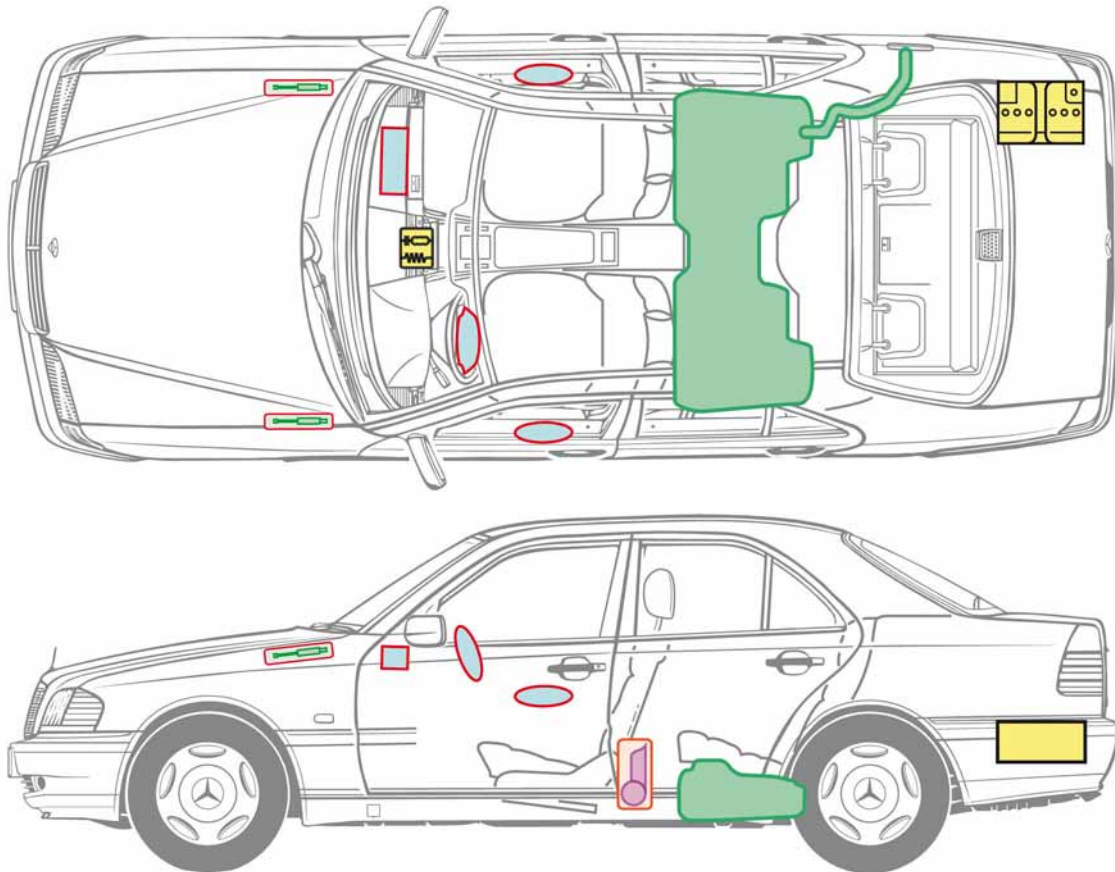

	Airbag		Structural reinforcements		Control unit
	Gas generator		Rollover protection		Battery
	Seat belt tensioner		Gas filled spring device		Fuel tank

**C-Class
Sedan
Model 202**

1993-2001

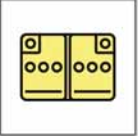

Legend

	Airbag		Structural reinforcements		Control unit
	Gas generator		Rollover protection		Battery
	Seat belt tensioner		Gas filled spring device		Fuel tank





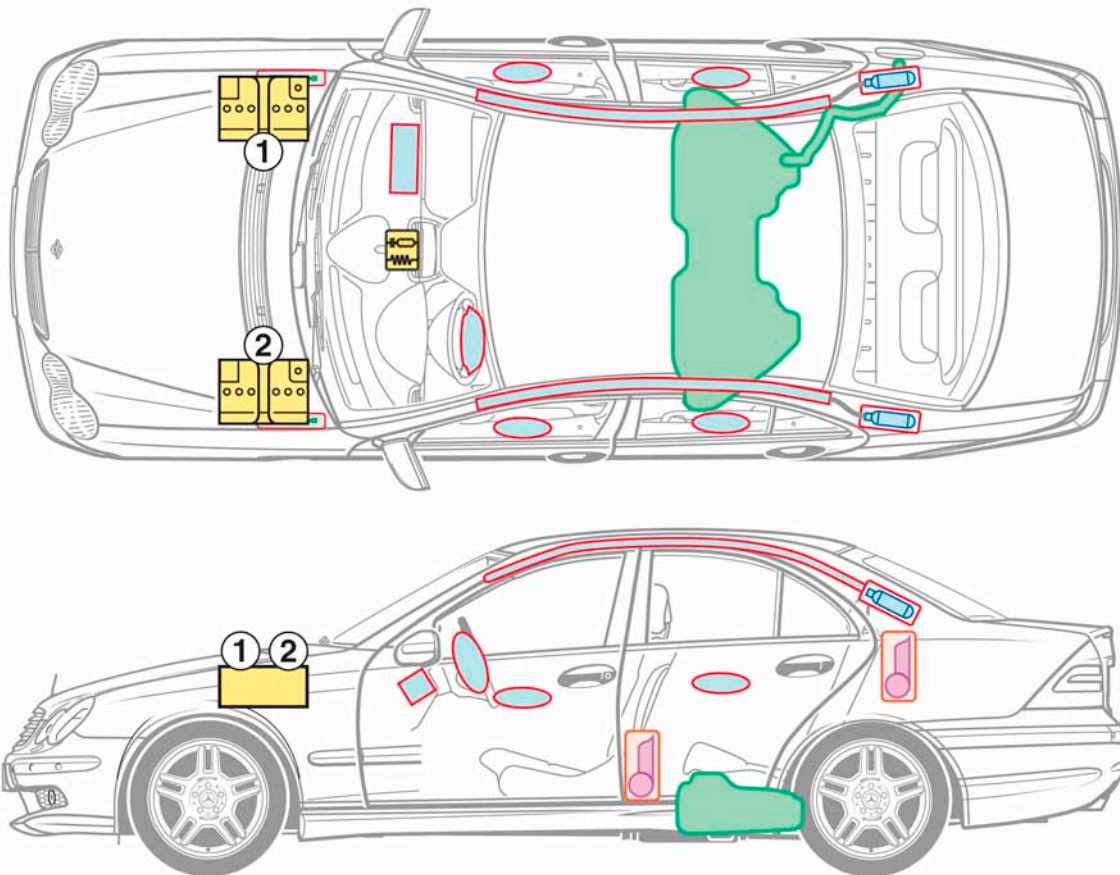

**C-Class
Sedan
Model 203**

2000-2007

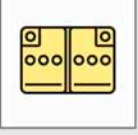
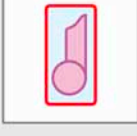
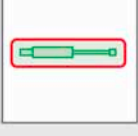

1 LHD vehicle
2 RHD vehicle

Legend

	Airbag		Structural reinforcements		Control unit
	Gas generator		Rollover protection		Battery
	Seat belt tensioner		Gas filled spring device		Fuel tank





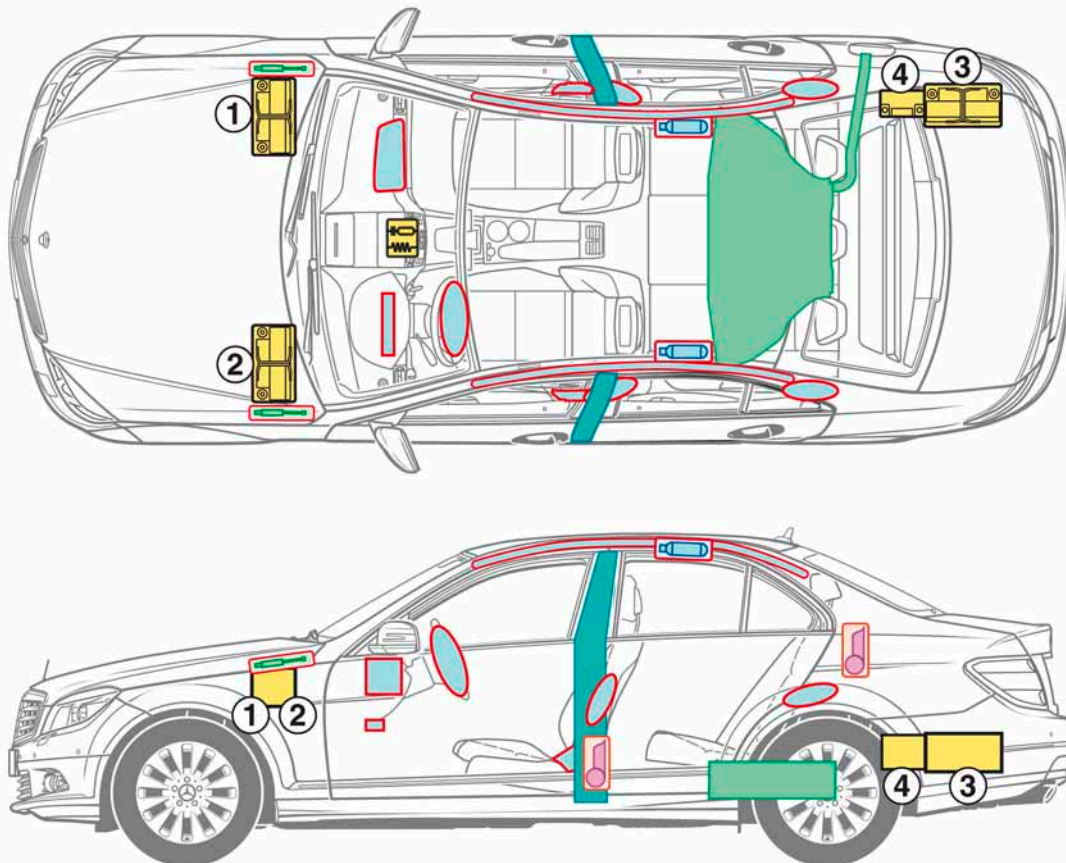

**C-Class
Sedan
Model 204**

as of 2007

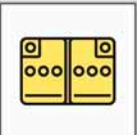
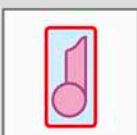
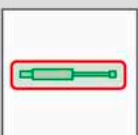

- 1 Power supply battery with gasoline engine, as of 1.12.09 with 4- and 8-cylinder diesel engine and AMG, LHD
- 2 Power supply battery with gasoline engine, as of 1.12.09 with 4- and 8-cylinder diesel engine and AMG, RHD
- 3 Power supply battery with 6-cylinder diesel engine, up to 30.11.09 with 4- and 8-cylinder diesel engine and AMG
- 4 Additional battery ECO Start-Stop

Legend

	Airbag		Structural reinforcements		Control unit
	Gas generator		Rollover protection		Battery
	Seat belt tensioner		Gas filled spring device		Fuel tank





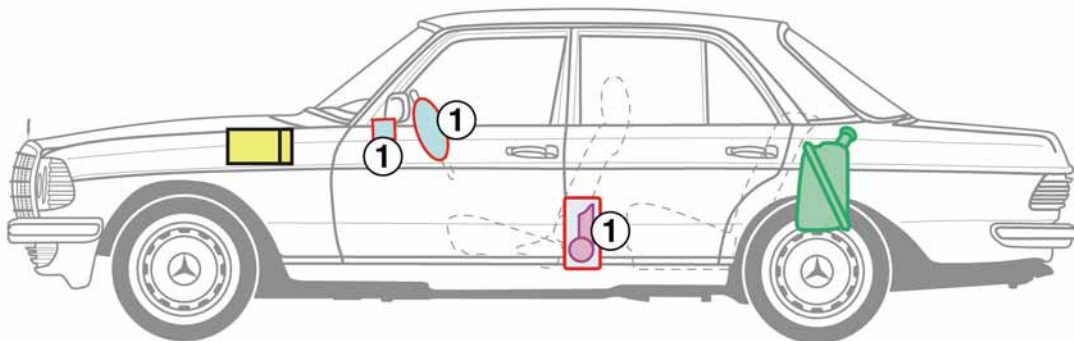
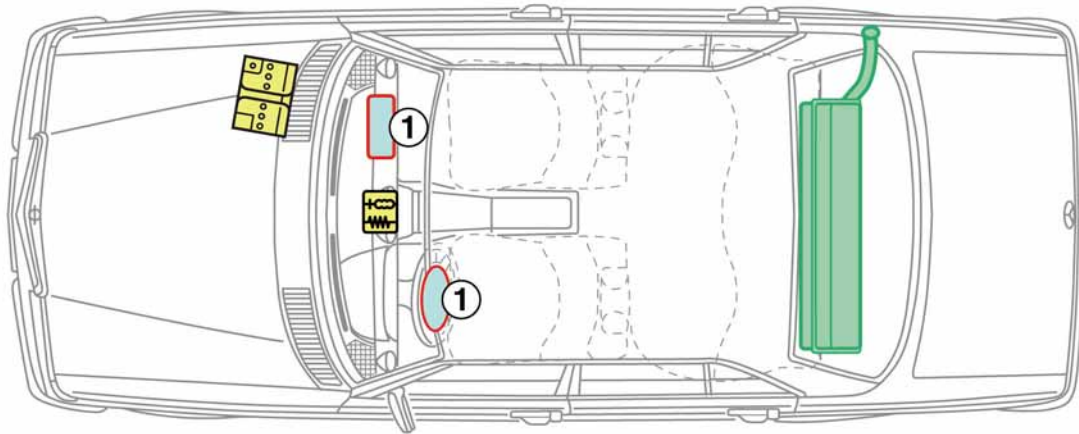



**E-Class
Sedan
Model 123**

1975-1986

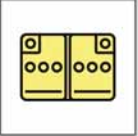

1 as of 1980

Legend

	Airbag		Structural reinforcements		Control unit
	Gas generator		Rollover protection		Battery
	Seat belt tensioner		Gas filled spring device		Fuel tank





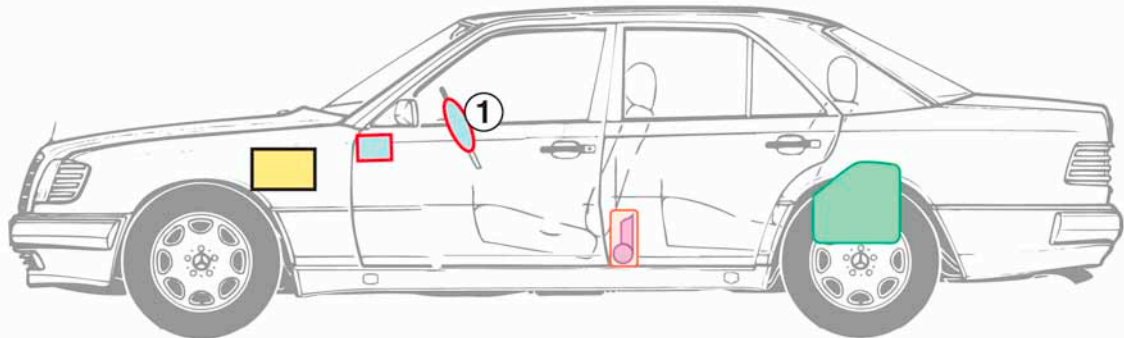
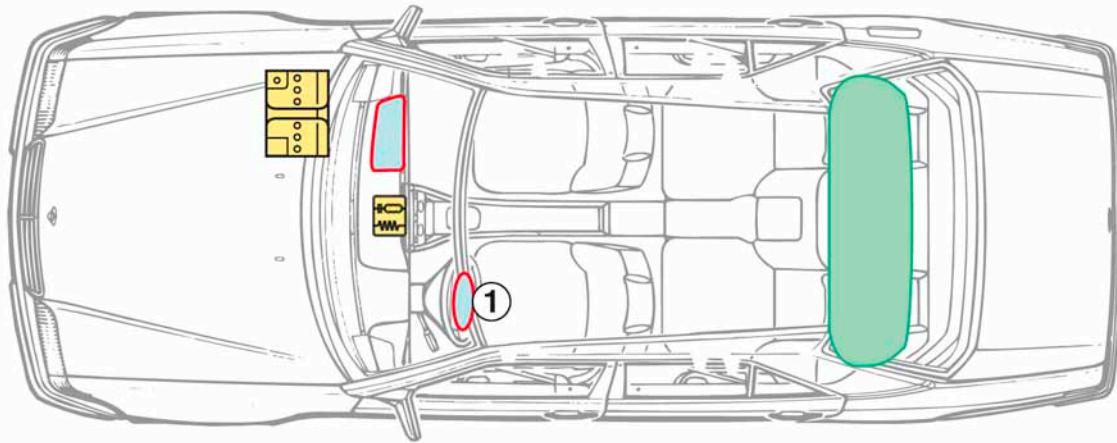

**E-Class
Sedan
Model 124**

1984-1995

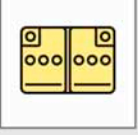
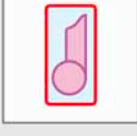
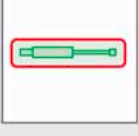

1 Standard as of 1992

Legend





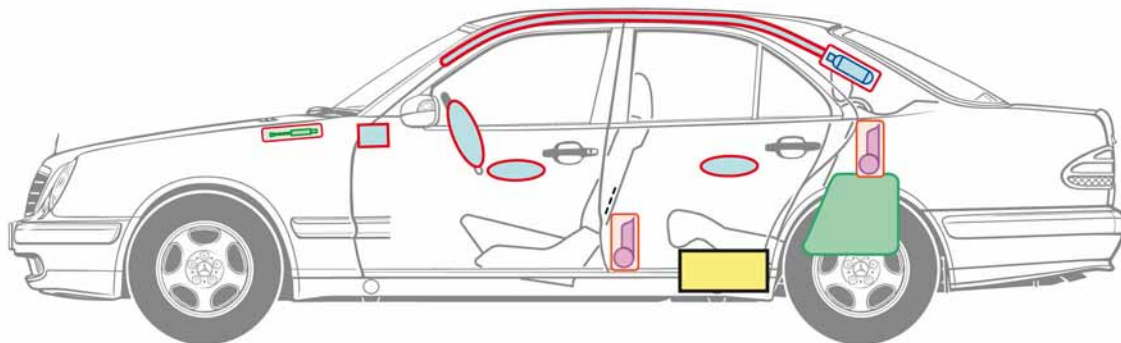
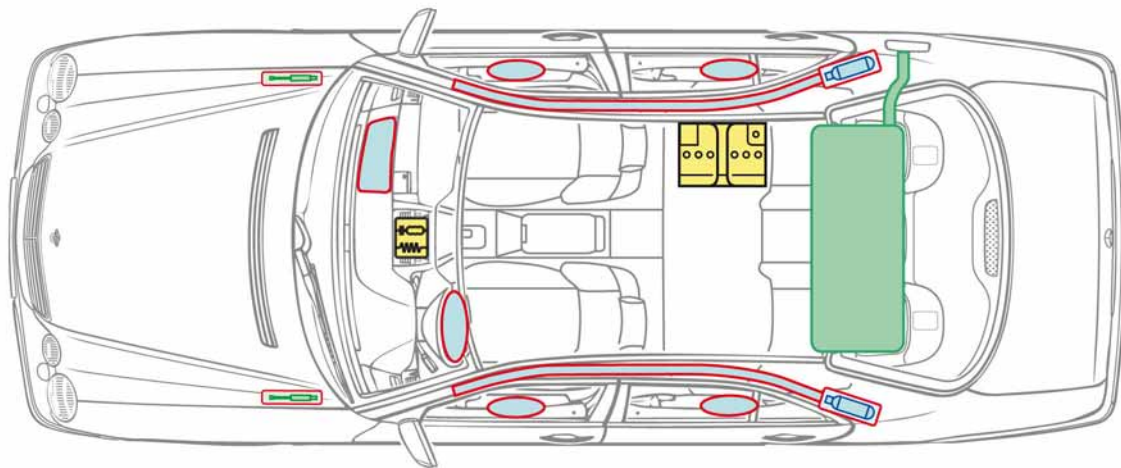

	Airbag		Structural reinforcements		Control unit
	Gas generator		Rollover protection		Battery
	Seat belt tensioner		Gas filled spring device		Fuel tank

**E-Class
Sedan
Model 210**

1995-2002

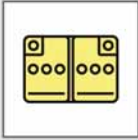
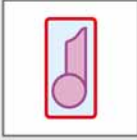

Legend

	Airbag		Structural reinforcements		Control unit
	Gas generator		Rollover protection		Battery
	Seat belt tensioner		Gas filled spring device		Fuel tank

**E-Class
Sedan
Model 211**



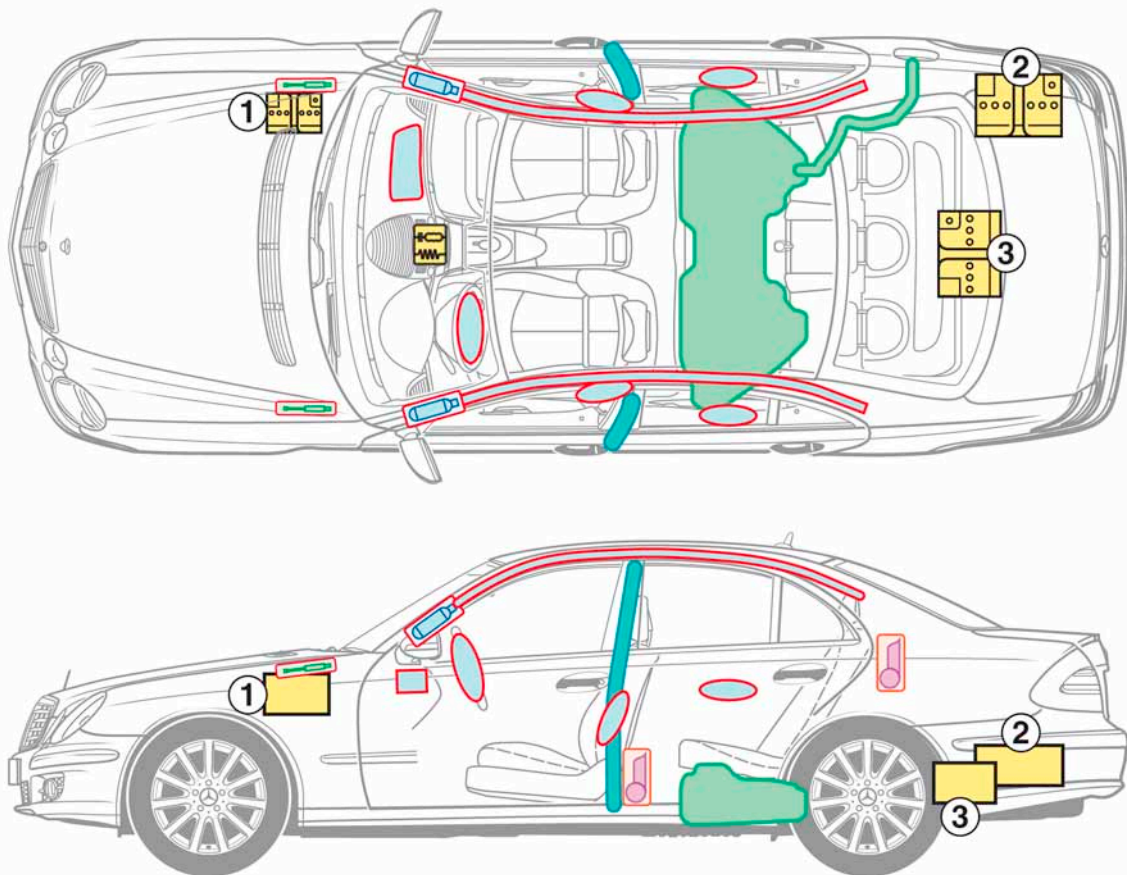



2002-2009



1 Additional battery (engine compartment)
2 Main battery (equipment with spare wheel)

3 Main battery (equipment without spare wheel)

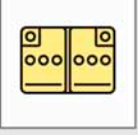
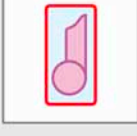
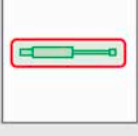
Legend

	Airbag		Structural reinforcements		Control unit
	Gas generator		Rollover protection		Battery
	Seat belt tensioner		Gas filled spring device		Fuel tank

**E-Class
NGT
Sedan
Model 211**



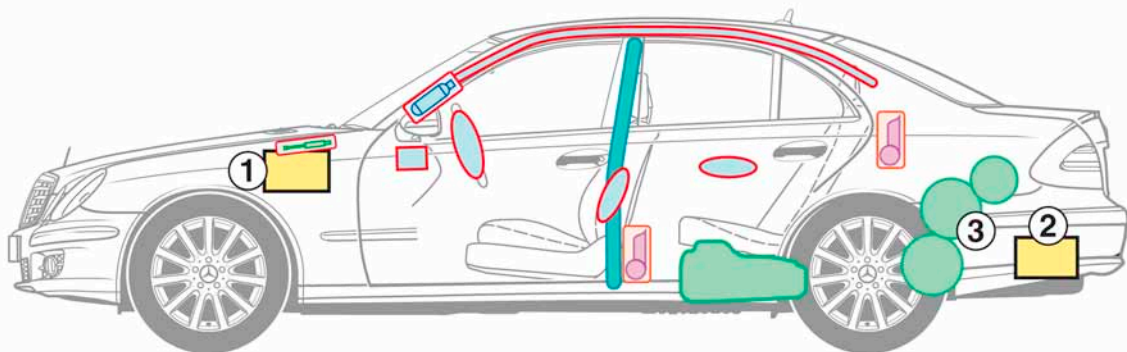
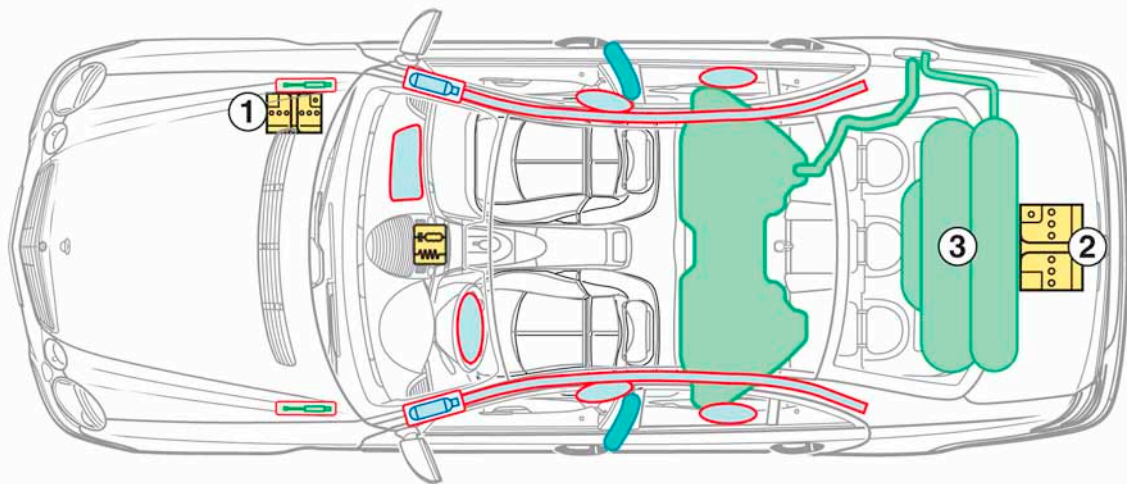





2004-2009

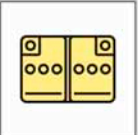

1 Additional battery (engine compartment)
2 Main battery (trunk)

3 Gas cylinder

Legend

	Airbag		Structural reinforcements		Control unit
	Gas generator		Rollover protection		Battery
	Seat belt tensioner		Gas filled spring device		Fuel tank

**E-Class
Sedan
Model 212**



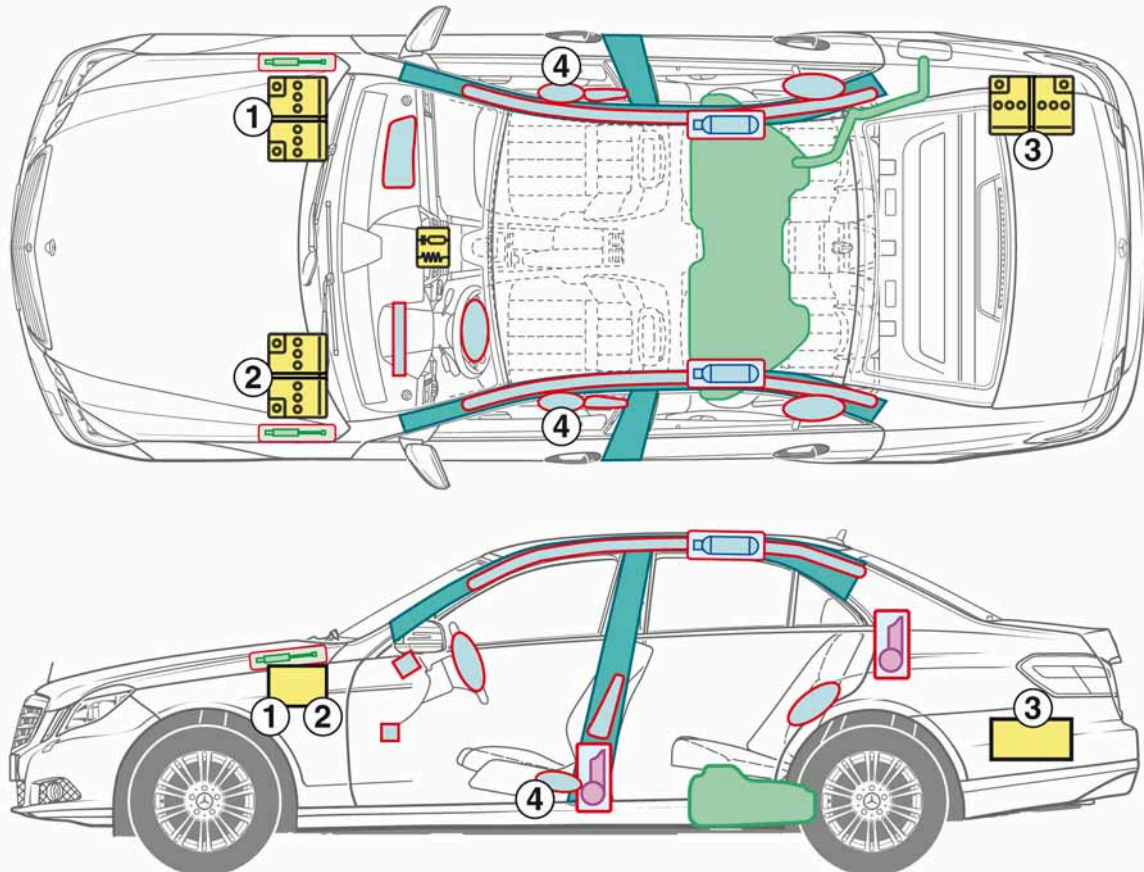





as of 2009

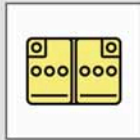

- 1 LHD, with 4- and 6-cylinder engine,
8-cylinder engine as of MY 2011
2 RHD, with 4- and 6-cylinder engine,
8-cylinder engine as of MY 2011

- 3 with 8-cylinder engine (up to MY 2011)
4 Pelvisbag (as of 06.2009)

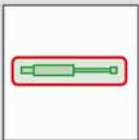
Legend

	Airbag		Structural reinforcements		Control unit
	Gas generator		Rollover protection		Battery
	Seat belt tensioner		Gas filled spring device		Fuel tank





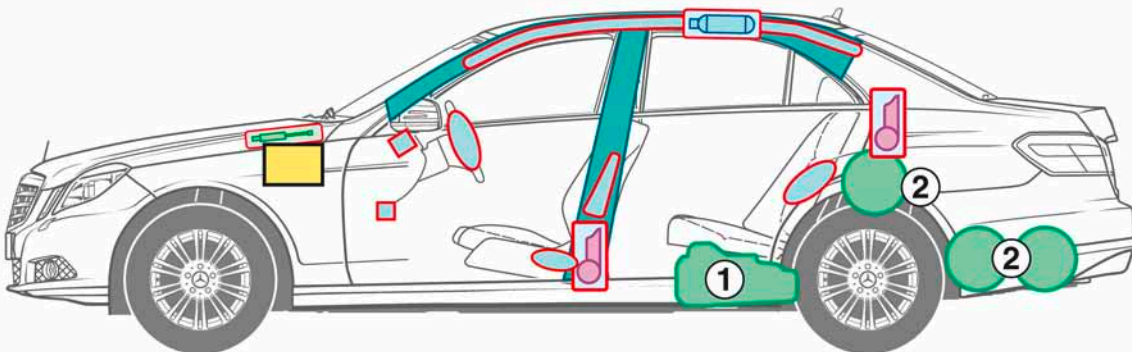
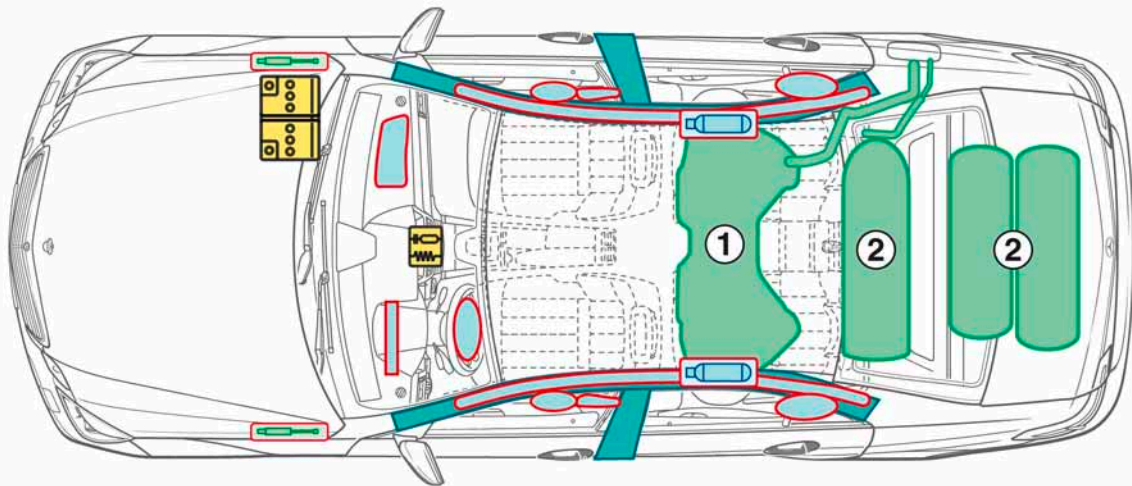

**E-Class
NGT
Sedan**

**Model 212
as of 2010**

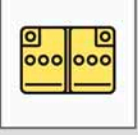
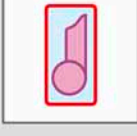
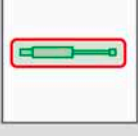

- 1 Fuel tank
- 2 Gas cylinder

Legend





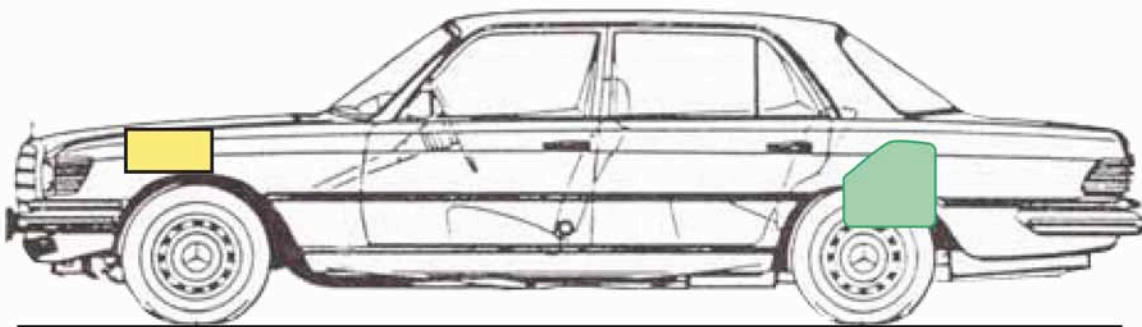
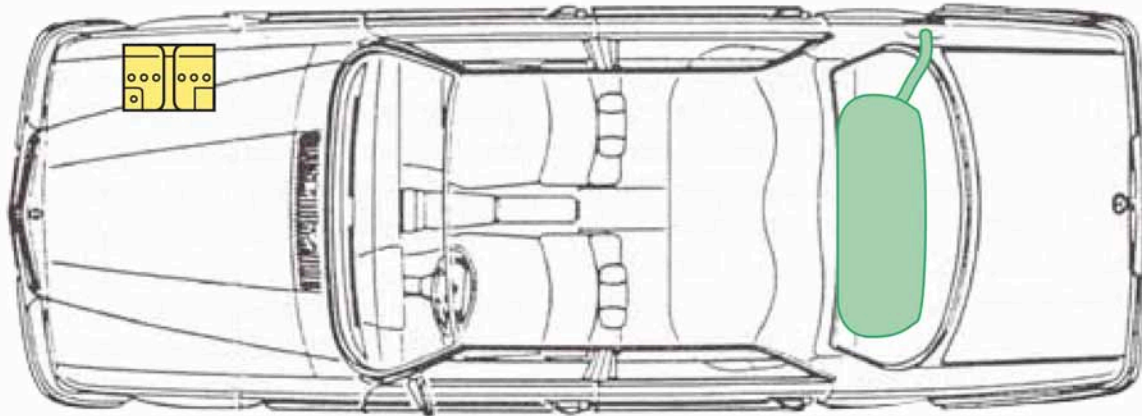

	Airbag		Structural reinforcements		Control unit
	Gas generator		Rollover protection		Battery
	Seat belt tensioner		Gas filled spring device		Fuel tank

**S-Class
Sedan
Model 116**

1972-1980

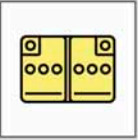
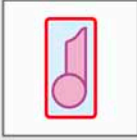

Legend





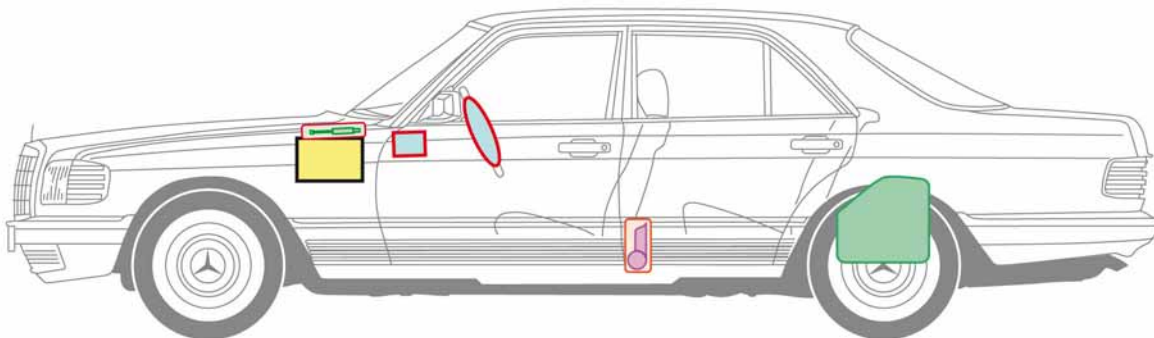
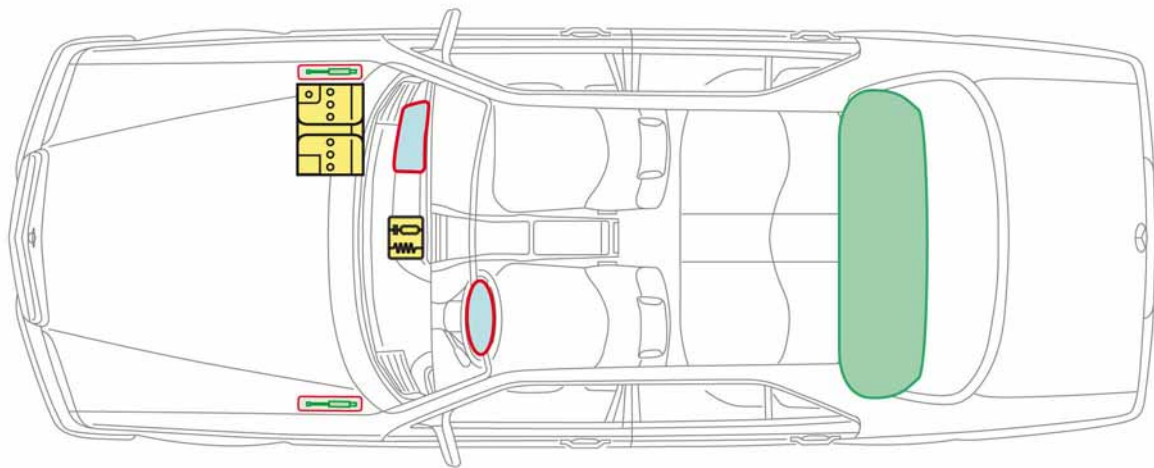

	Airbag		Structural reinforcements		Control unit
	Gas generator		Rollover protection		Battery
	Seat belt tensioner		Gas filled spring device		Fuel tank

**S-Class
Sedan
Model 126**

1979-1991

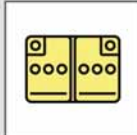
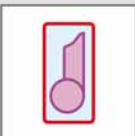
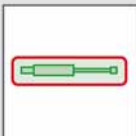

Legend

	Airbag		Structural reinforcements		Control unit
	Gas generator		Rollover protection		Battery
	Seat belt tensioner		Gas filled spring device		Fuel tank





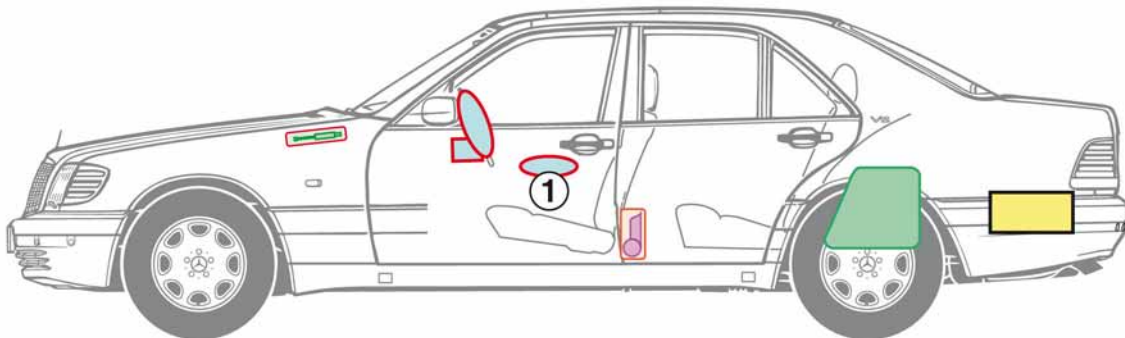
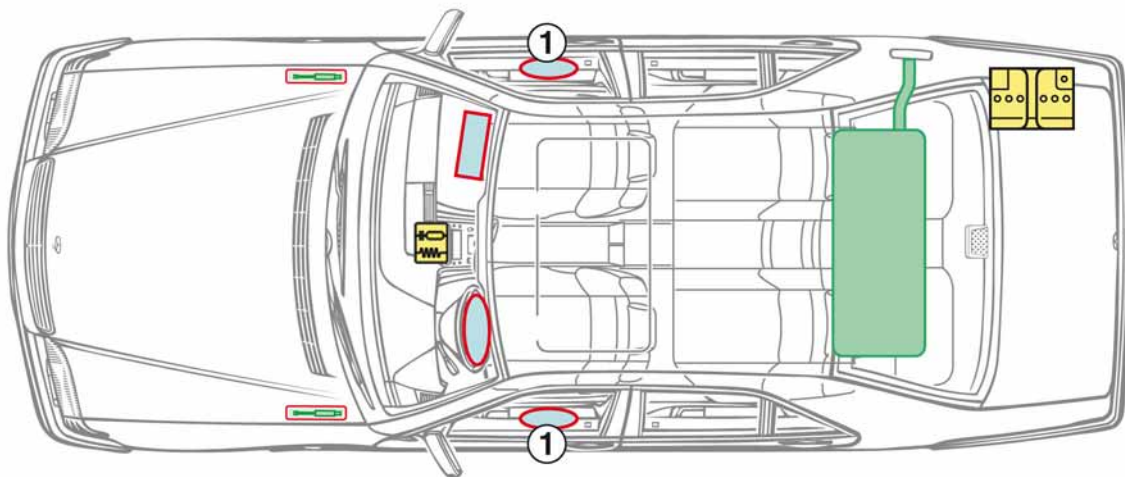



**S-Class
Sedan
Model 140**

1991-1998

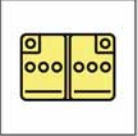

1 Special equipment

Legend







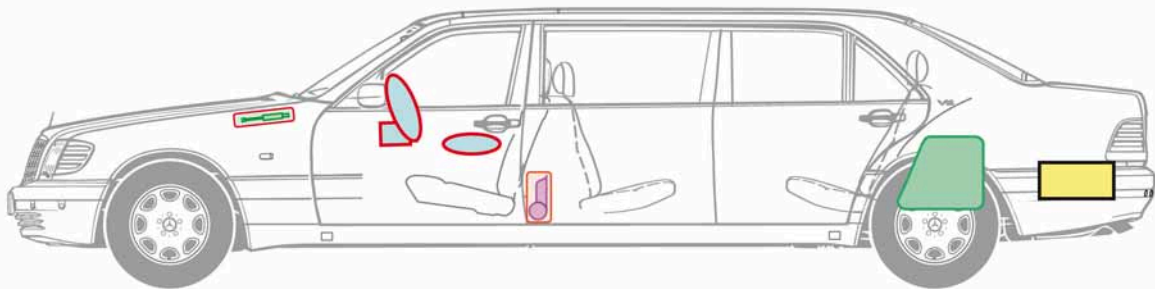
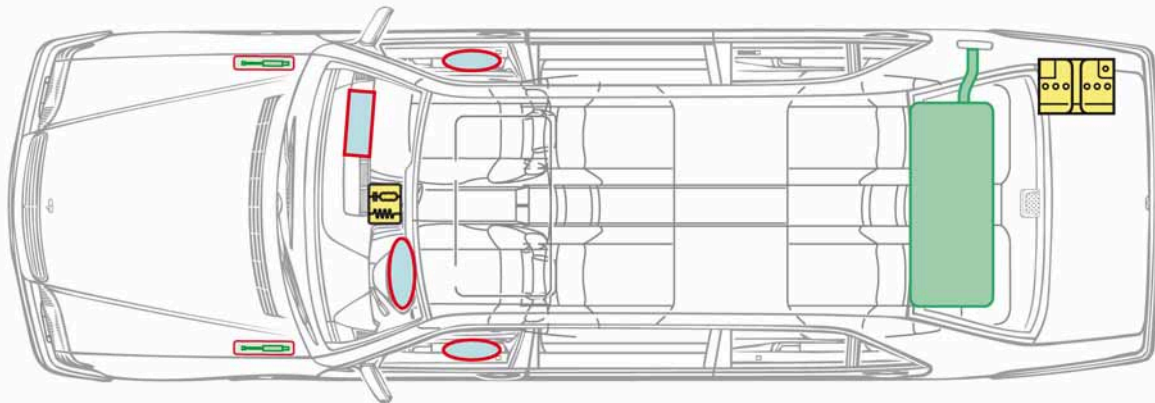

	Airbag		Structural reinforcements		Control unit
	Gas generator		Rollover protection		Battery
	Seat belt tensioner		Gas filled spring device		Fuel tank

**S-Class
Pullman
Sedan
Model 140**

1996-2000

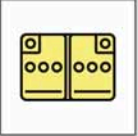

Legend





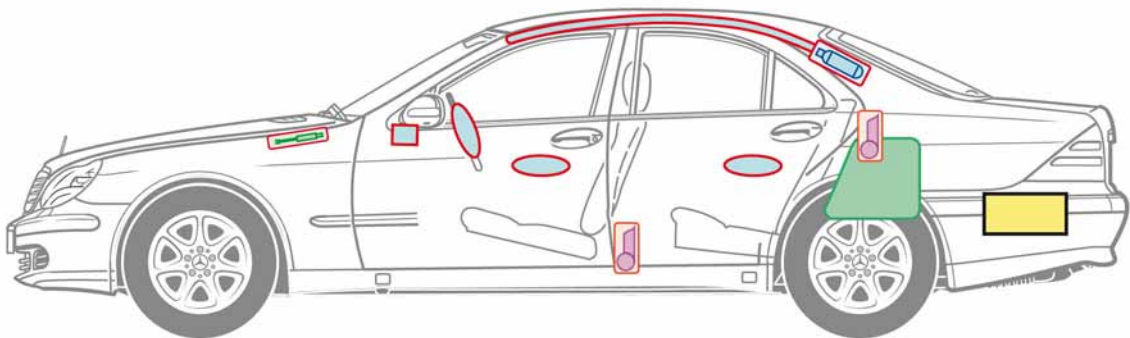
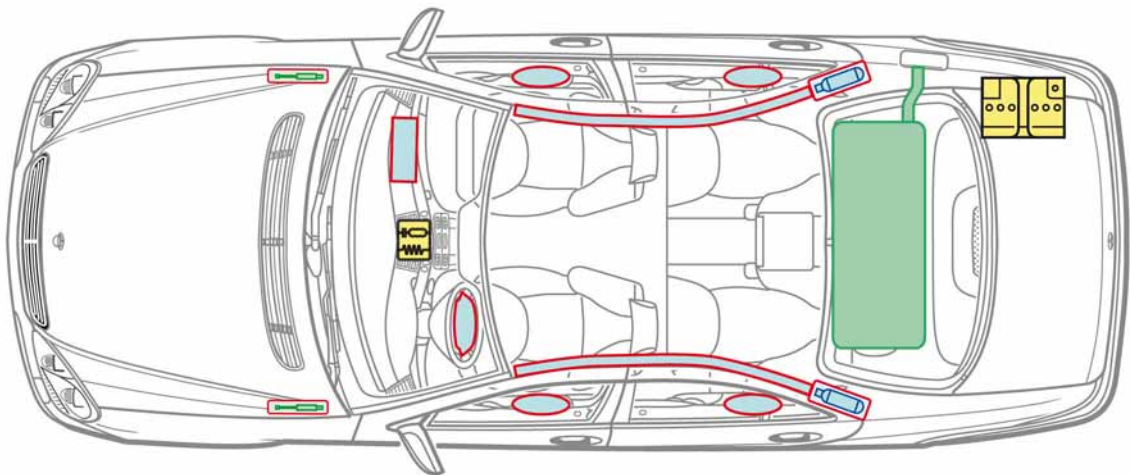

	Airbag		Structural reinforcements		Control unit
	Gas generator		Rollover protection		Battery
	Seat belt tensioner		Gas filled spring device		Fuel tank

**S-Class
Sedan
Model 220**

1998-2005

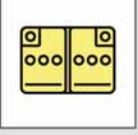
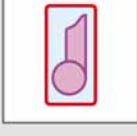
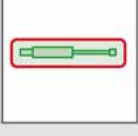

Legend







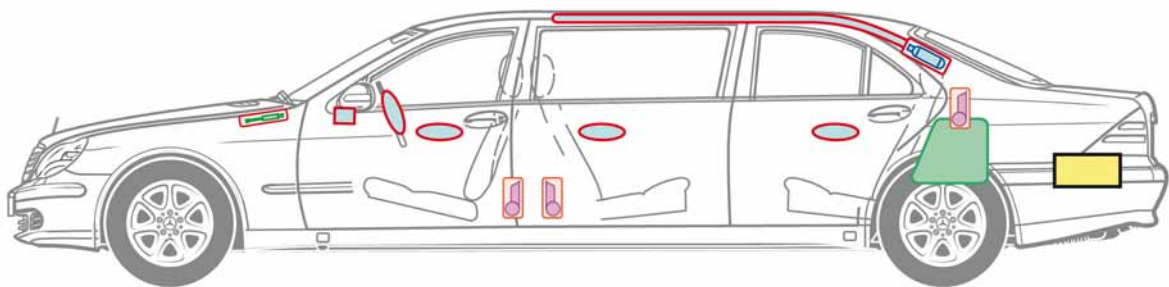
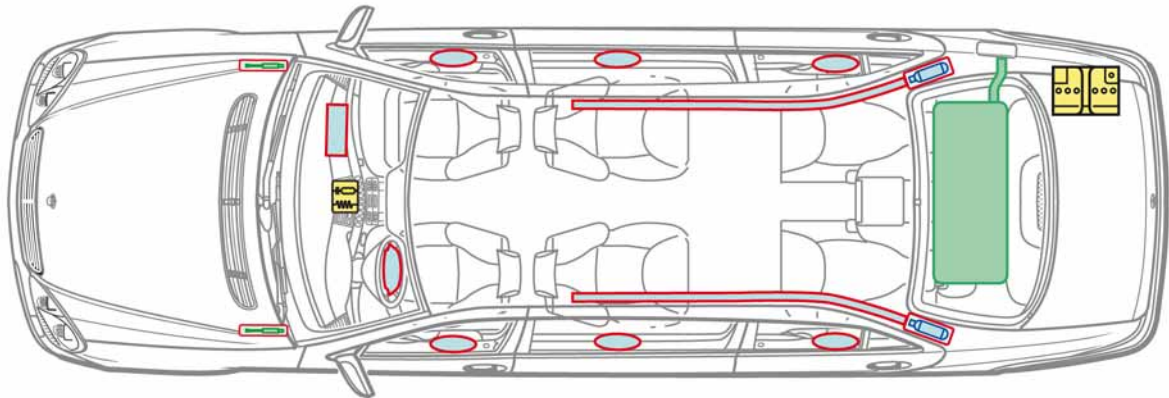

	Airbag		Structural reinforcements		Control unit
	Gas generator		Rollover protection		Battery
	Seat belt tensioner		Gas filled spring device		Fuel tank

**S-Class
Pullman
Sedan
Model 220**

2000-2005

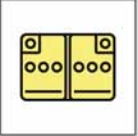

Legend

	Airbag		Structural reinforcements		Control unit
	Gas generator		Rollover protection		Battery
	Seat belt tensioner		Gas filled spring device		Fuel tank

**S-Class
Sedan
Model 221**



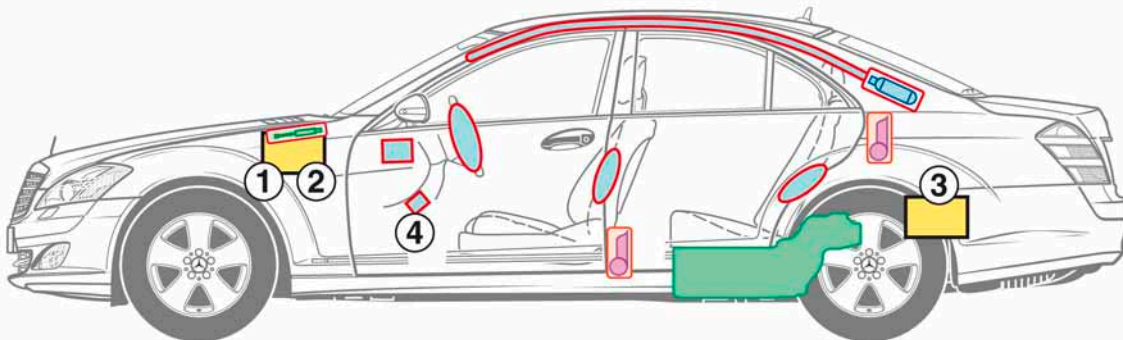
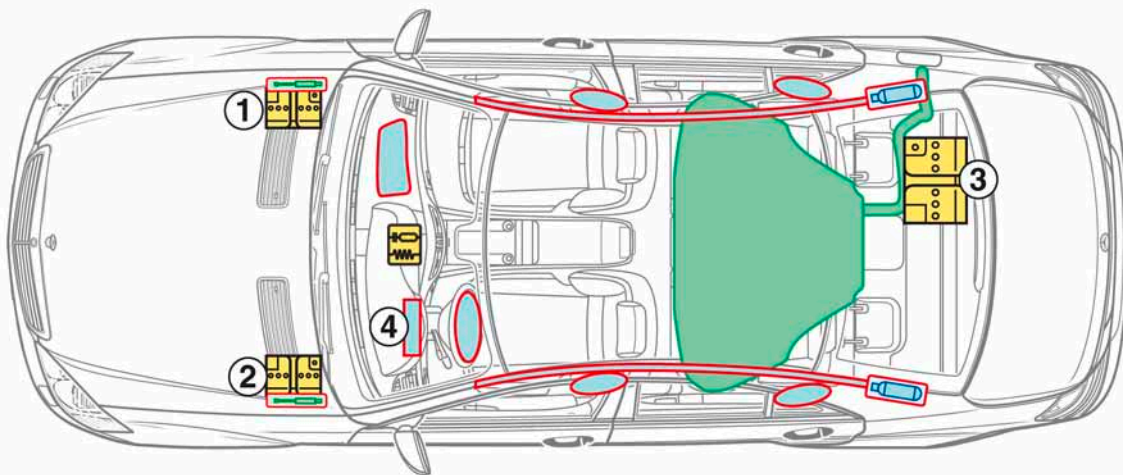



as of 2005



1 Battery (engine compartment, LHD)
2 Battery (engine compartment, RHD)

3 Battery trunk (up to 08.08)
4 Kneebag driver (as of 09.08)

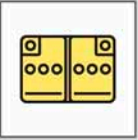
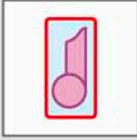
Legend

	Airbag		Structural reinforcements		Control unit
	Gas generator		Rollover protection		Battery
	Seat belt tensioner		Gas filled spring device		Fuel tank





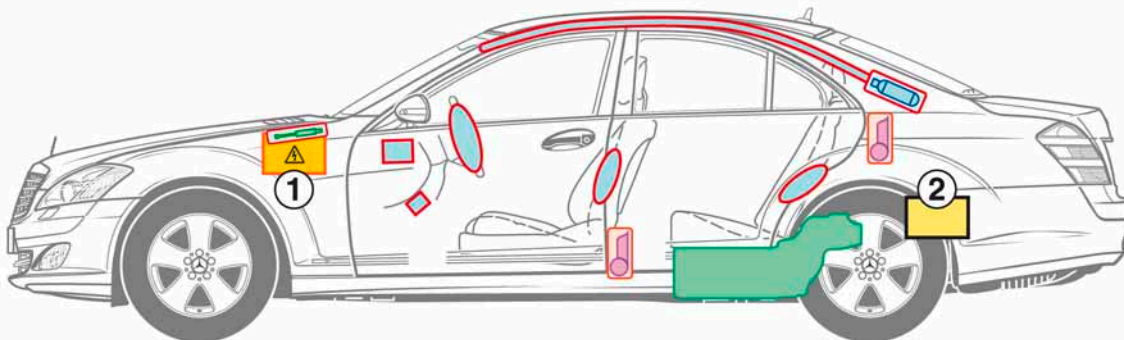
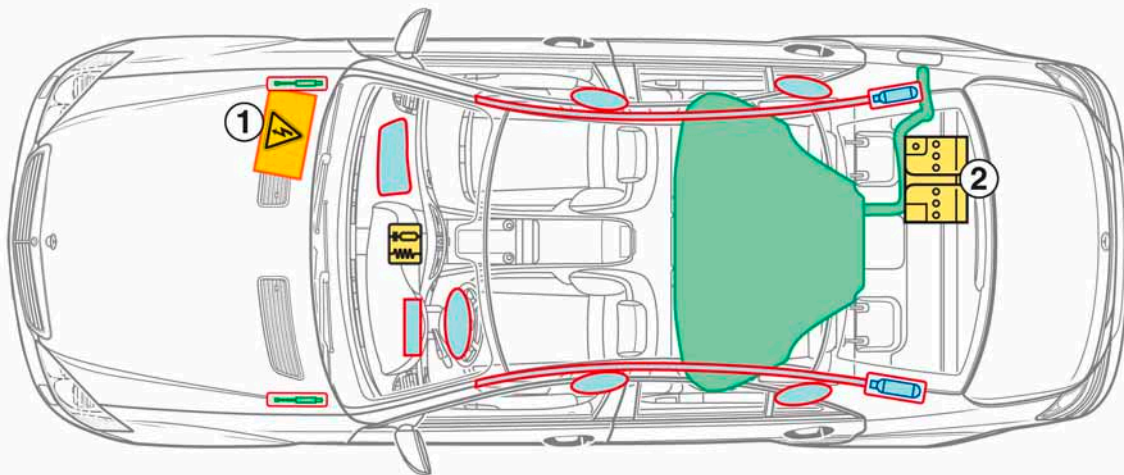

**S-Class
HYBRID
Sedan
Model 221**

as of 2009

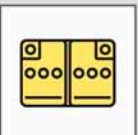
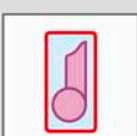
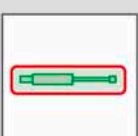

- 1 High-voltage battery (engine compartment)
2 Power supply battery (trunk)

Legend







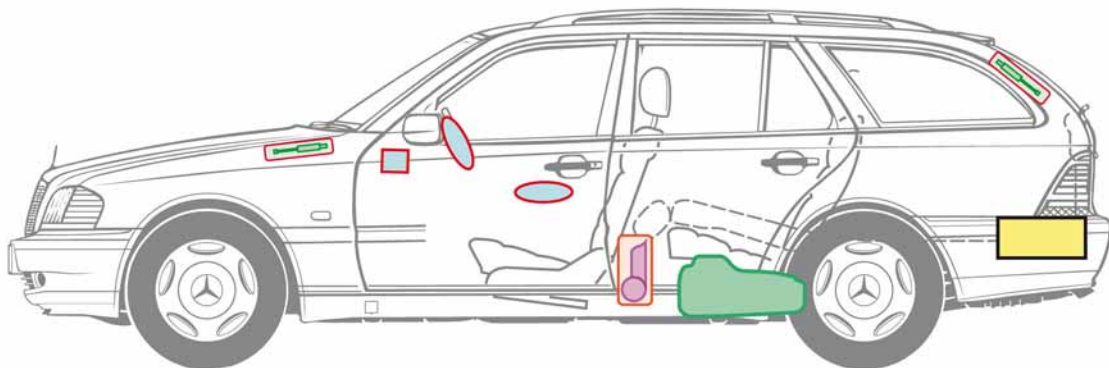
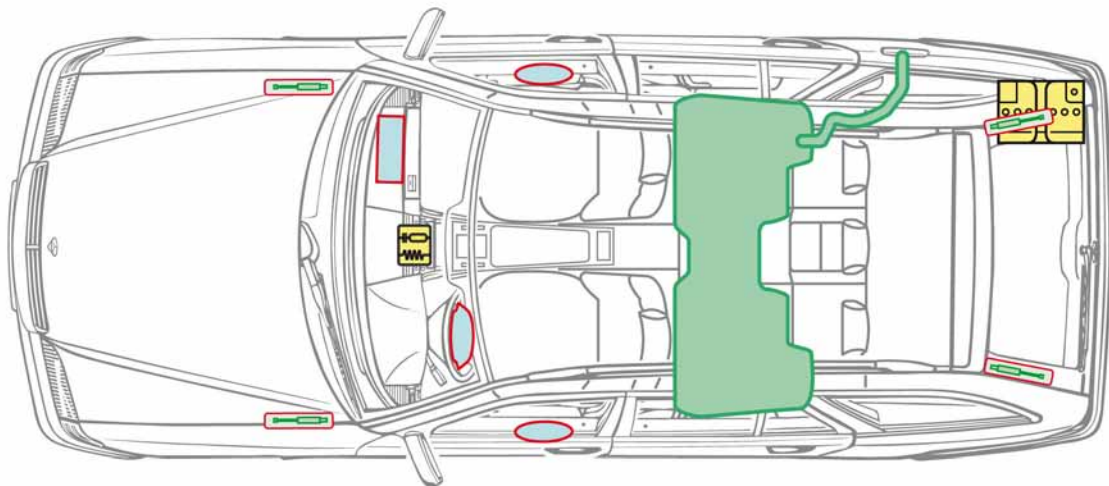

	Airbag		Structural reinforcements		Control unit
	Gas generator		High-voltage components		Battery
	Seat belt tensioner		Gas filled spring device		Fuel tank

**C-Class
T-Model
Model 202**

1996-2001

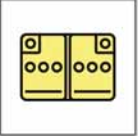

Legend

	Airbag		Structural reinforcements		Control unit
	Gas generator		Rollover protection		Battery
	Seat belt tensioner		Gas filled spring device		Fuel tank





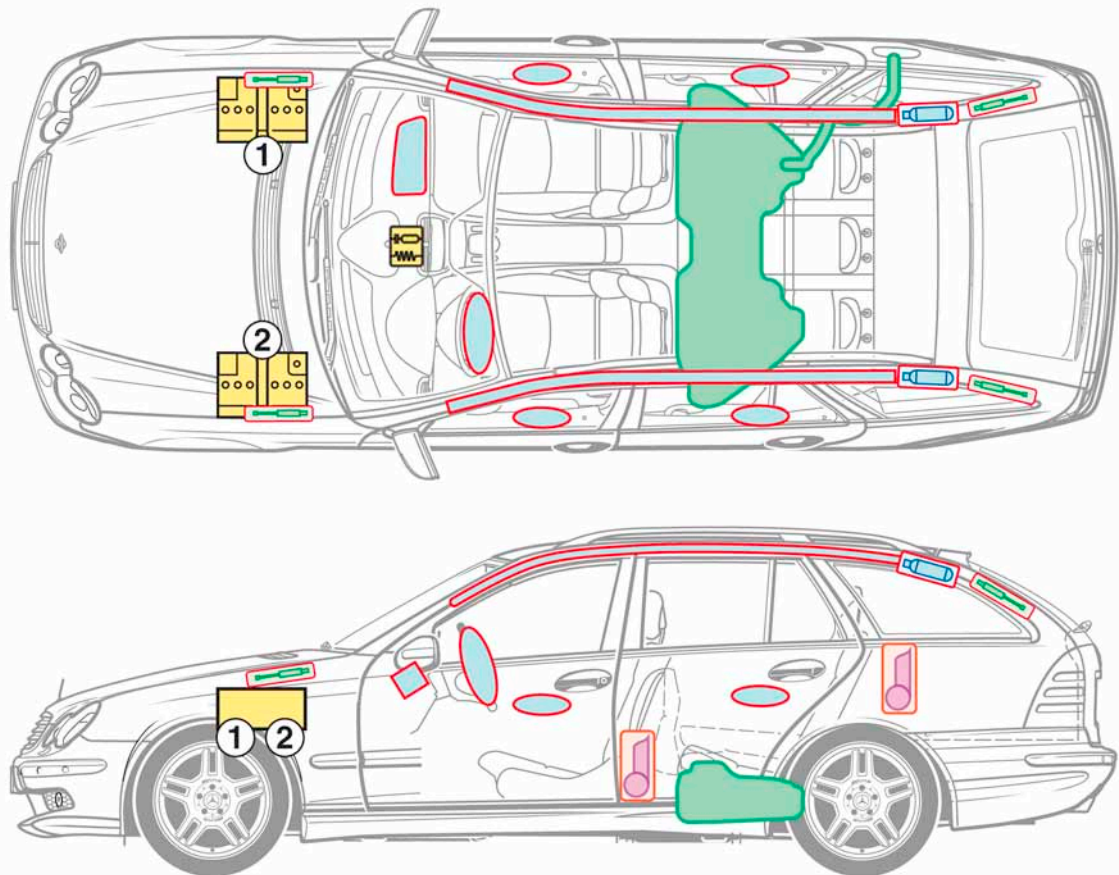



**C-Class
T-Model
Model 203**

2001-2007

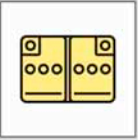

1 LHD vehicle
2 RHD vehicle

Legend

	Airbag		Structural reinforcements		Control unit
	Gas generator		Rollover protection		Battery
	Seat belt tensioner		Gas filled spring device		Fuel tank





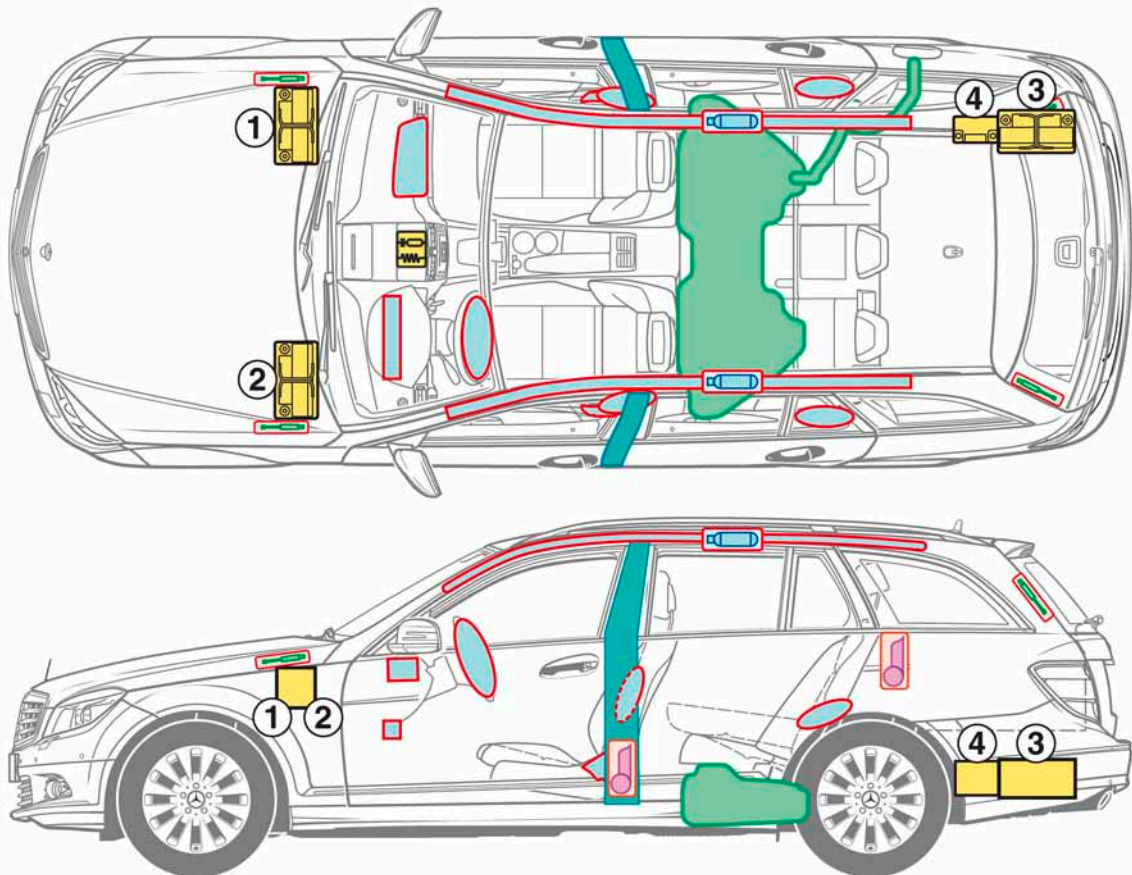

**C-Class
T-Model
Model 204**

as of 2007

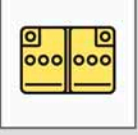
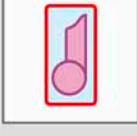
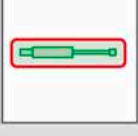

- 1 Power supply battery with gasoline engine, as of 1.12.09 with 4- and 8-cylinder diesel engine and AMG, LHD
- 2 Power supply battery with gasoline engine, as of 1.12.09 with 4- and 8-cylinder diesel engine and AMG, RHD
- 3 Power supply battery with 6-cylinder diesel engine, up to 30.11.09 with 4- and 8-cylinder diesel engine and AMG
- 4 Additional battery ECO Start-Stop

Legend

	Airbag		Structural reinforcements		Control unit
	Gas generator		Rollover protection		Battery
	Seat belt tensioner		Gas filled spring device		Fuel tank





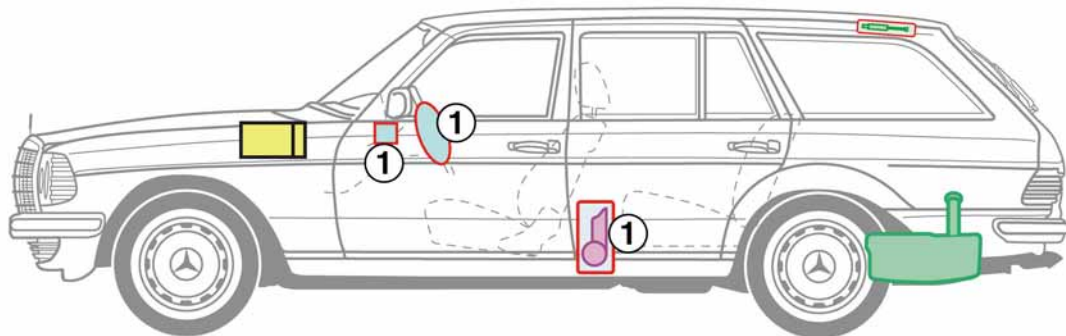
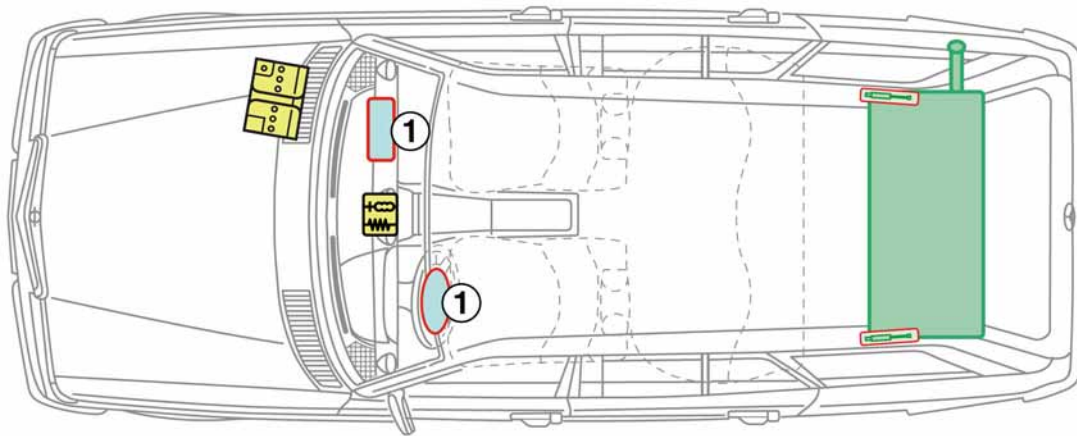

E-Class
T-Model
Model 123

1977-1986

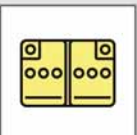
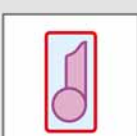
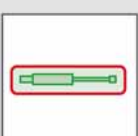

1 as of 1980

Legend

	Airbag		Structural reinforcements		Control unit
	Gas generator		Rollover protection		Battery
	Seat belt tensioner		Gas filled spring device		Fuel tank





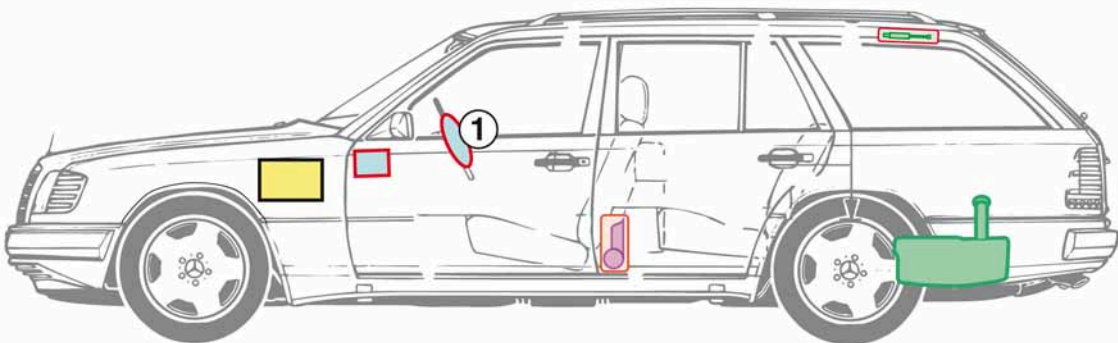
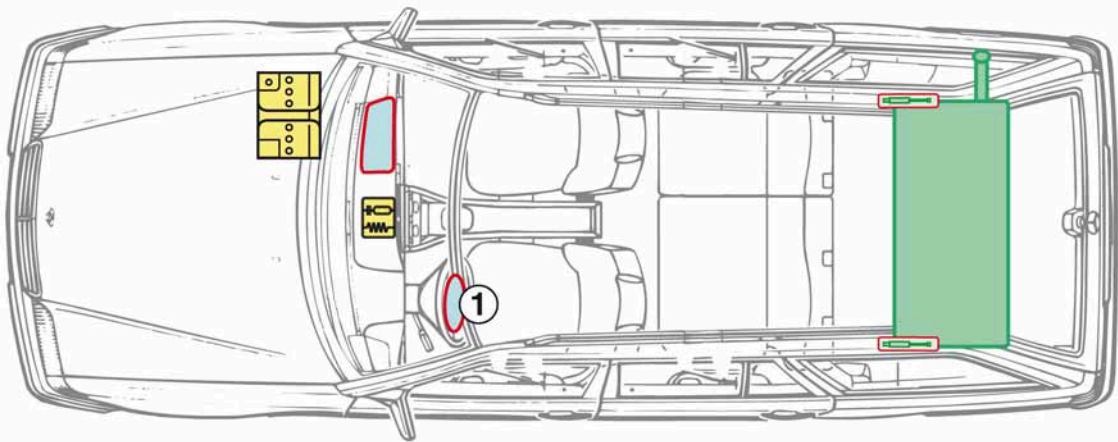



**E-Class
T-Model
Model 124**

1984-1996

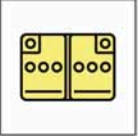

1 Standard as of 1992

Legend





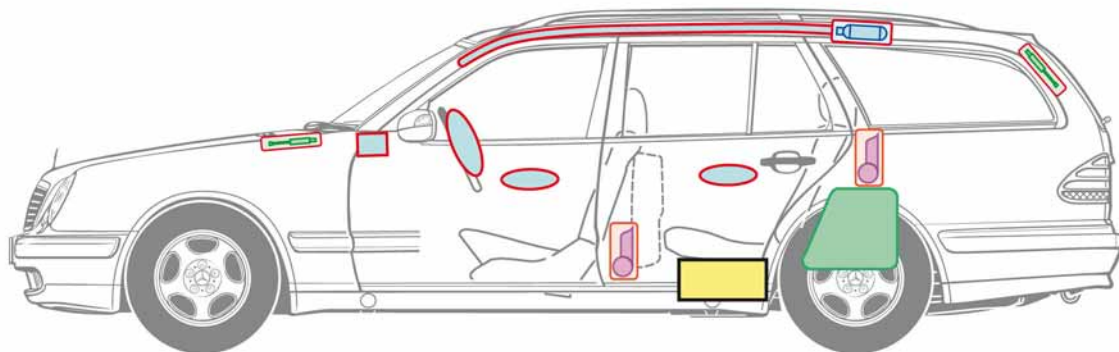
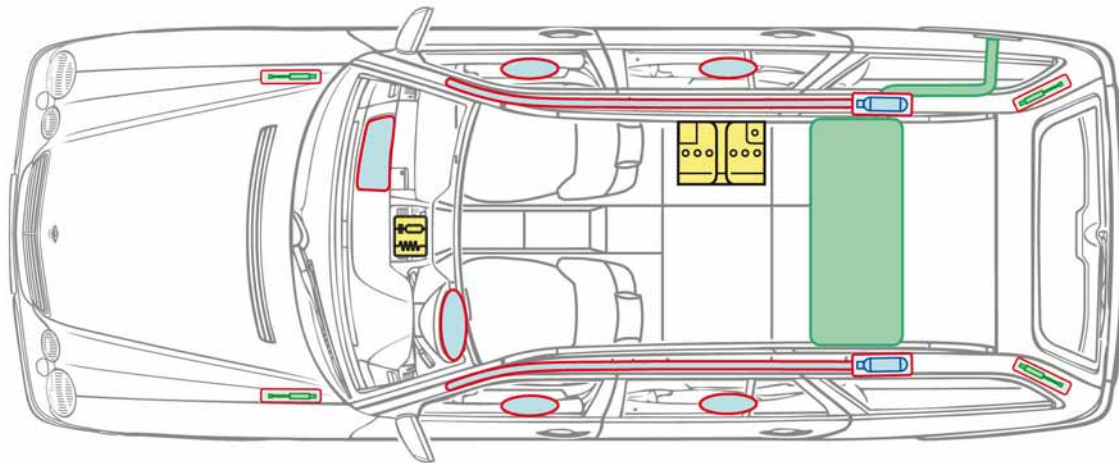

	Airbag		Structural reinforcements		Control unit
	Gas generator		Rollover protection		Battery
	Seat belt tensioner		Gas filled spring device		Fuel tank

**E-Class
T-Model
Model 210**

1996-2003

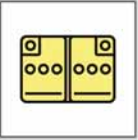
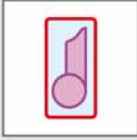

Legend

	Airbag		Structural reinforcements		Control unit
	Gas generator		Rollover protection		Battery
	Seat belt tensioner		Gas filled spring device		Fuel tank

**E-Class
T-Model
Model 211**

2003-2009

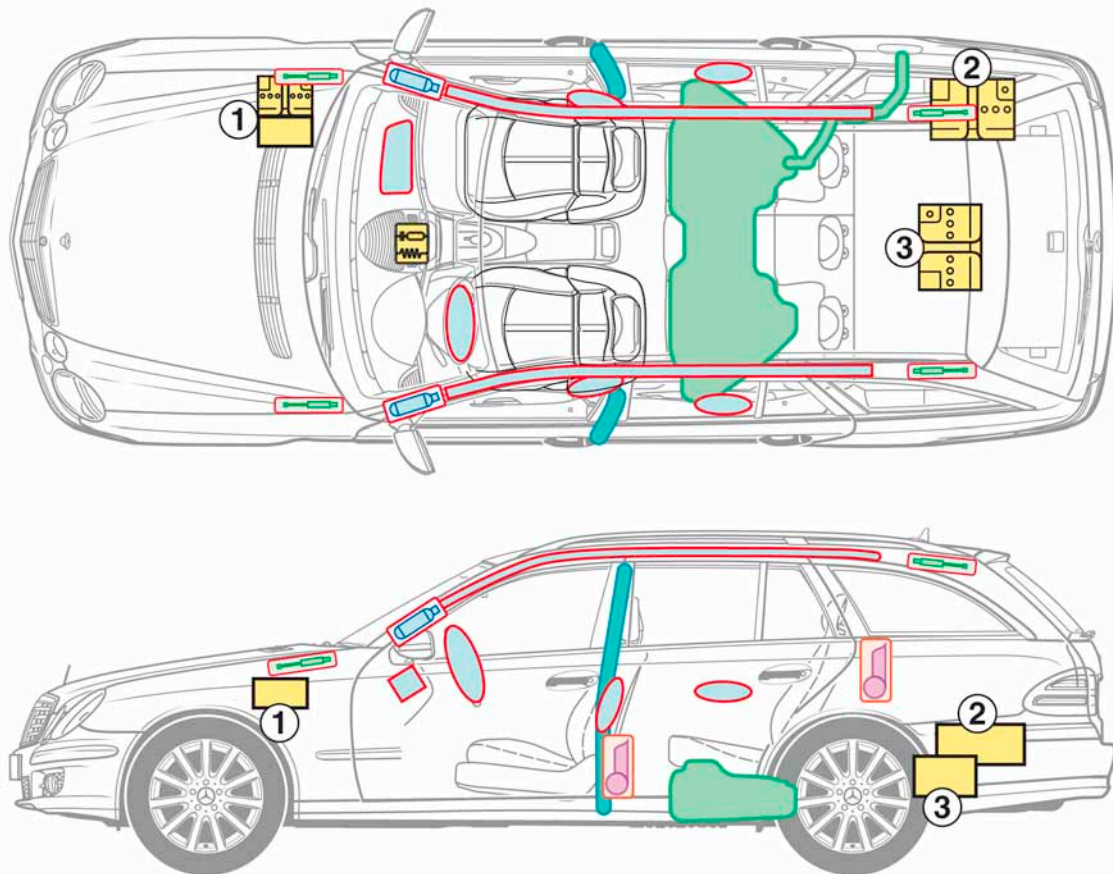

1 Additional battery (engine compartment)
2 Main battery (equipment with spare wheel)

3 Main battery (equipment without spare wheel)

Legend

	Airbag		Structural reinforcements		Control unit
	Gas generator		Rollover protection		Battery
	Seat belt tensioner		Gas filled spring device		Fuel tank

**E-Class
T-Model
Model 212**



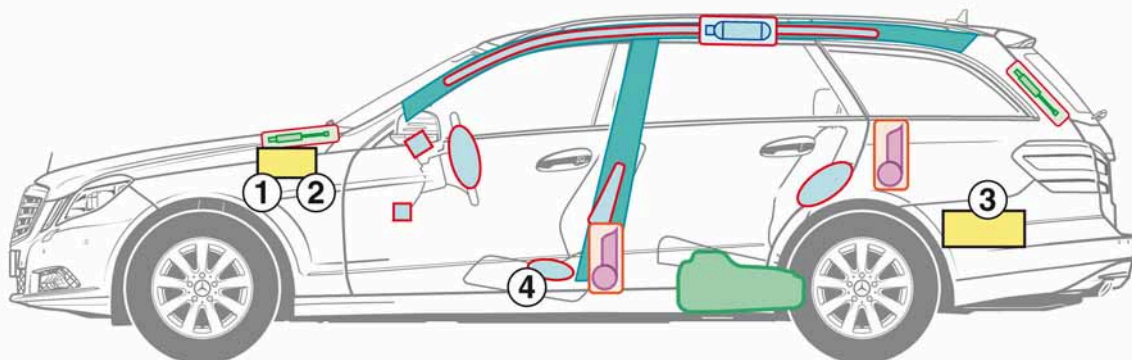
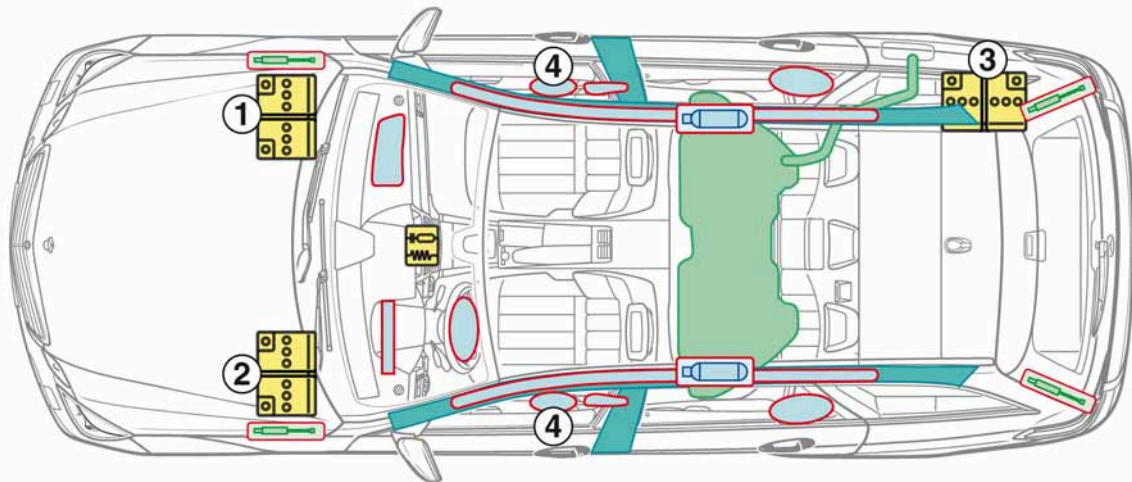





as of 2009

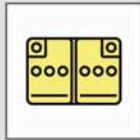

- 1 LHD, with 4- and 6-cylinder engine, 8-cylinder engine as of MY 2011
- 2 RHD, with 4- and 6-cylinder engine, 8-cylinder engine as of MY 2011

- 3 with 8-cylinder engine (up to MY 2011)
- 4 Pelvisbag (as of 06.2009)

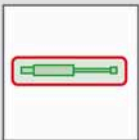
Legend

	Airbag		Structural reinforcements		Control unit
	Gas generator		Rollover protection		Battery
	Seat belt tensioner		Gas filled spring device		Fuel tank





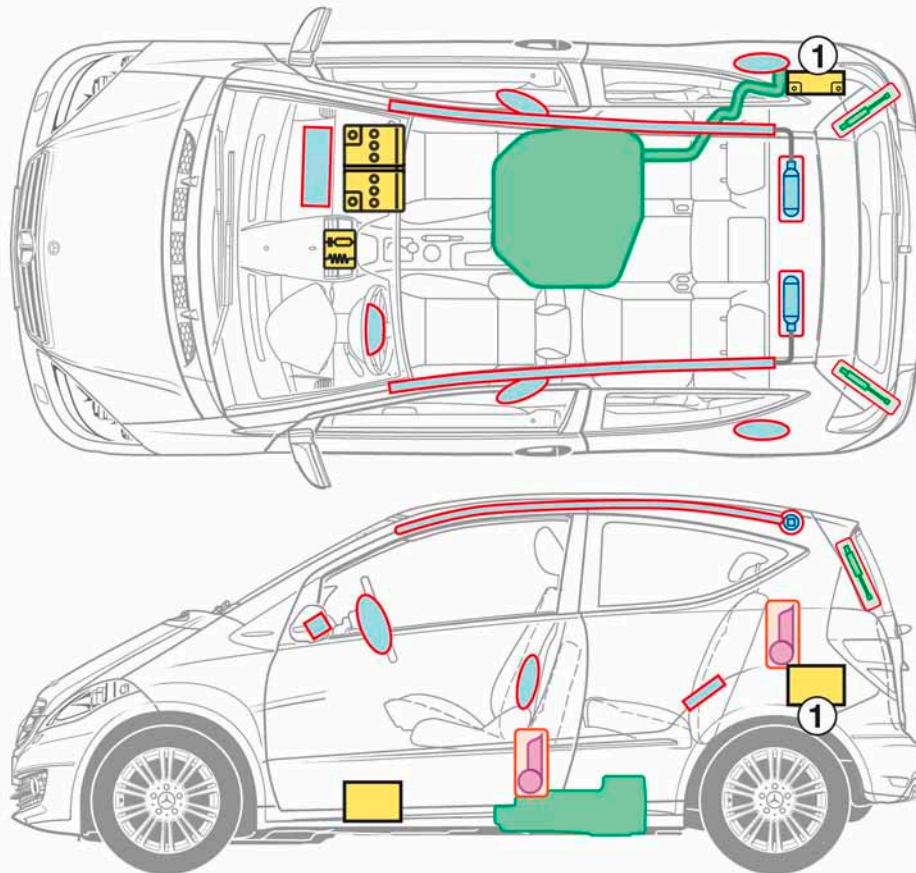

**A-Class
Coupé
Model 169**

as of 2004

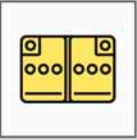
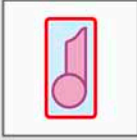

1 Additional battery BlueEFFICIENCY models

Legend

	Airbag		Structural reinforcements		Control unit
	Gas generator		Rollover protection		Battery
	Seat belt tensioner		Gas filled spring device		Fuel tank





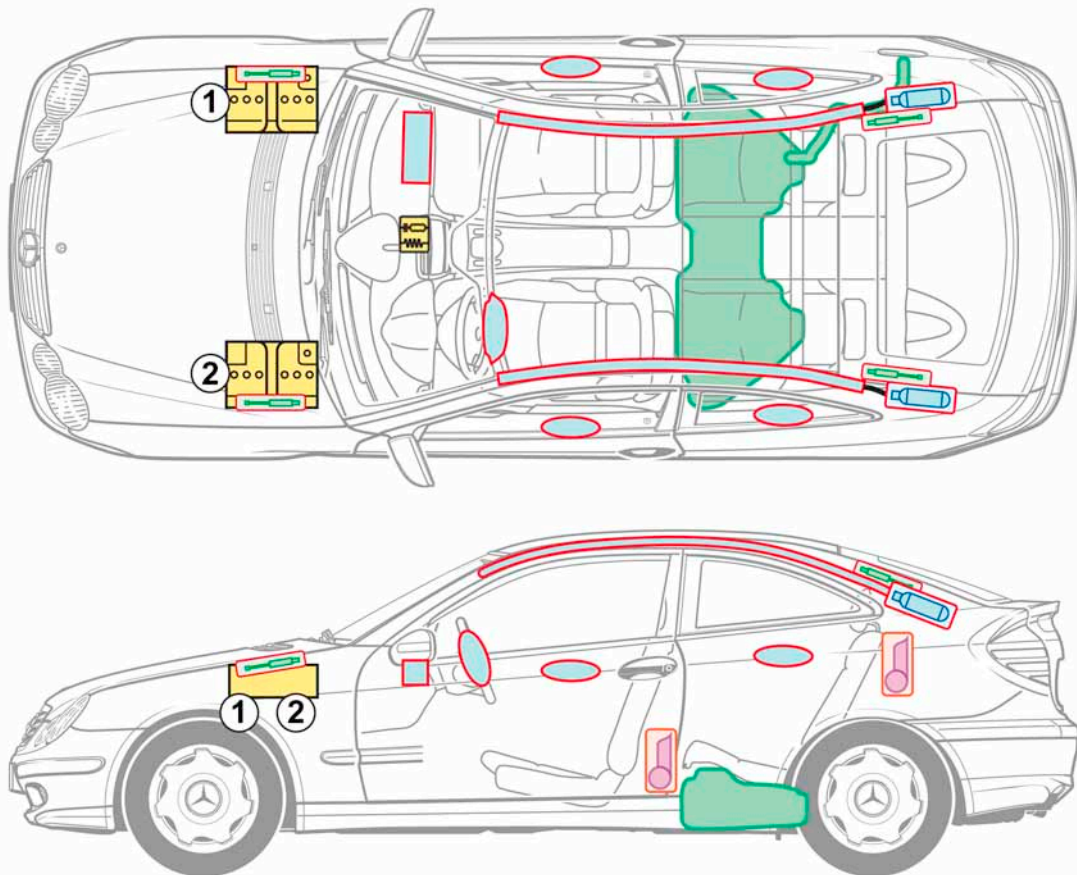



**C-Class
Sports coupé
Model 203**

2000-2008

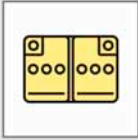

1 LHD vehicle
2 RHD vehicle

Legend

	Airbag		Structural reinforcements		Control unit
	Gas generator		Rollover protection		Battery
	Seat belt tensioner		Gas filled spring device		Fuel tank





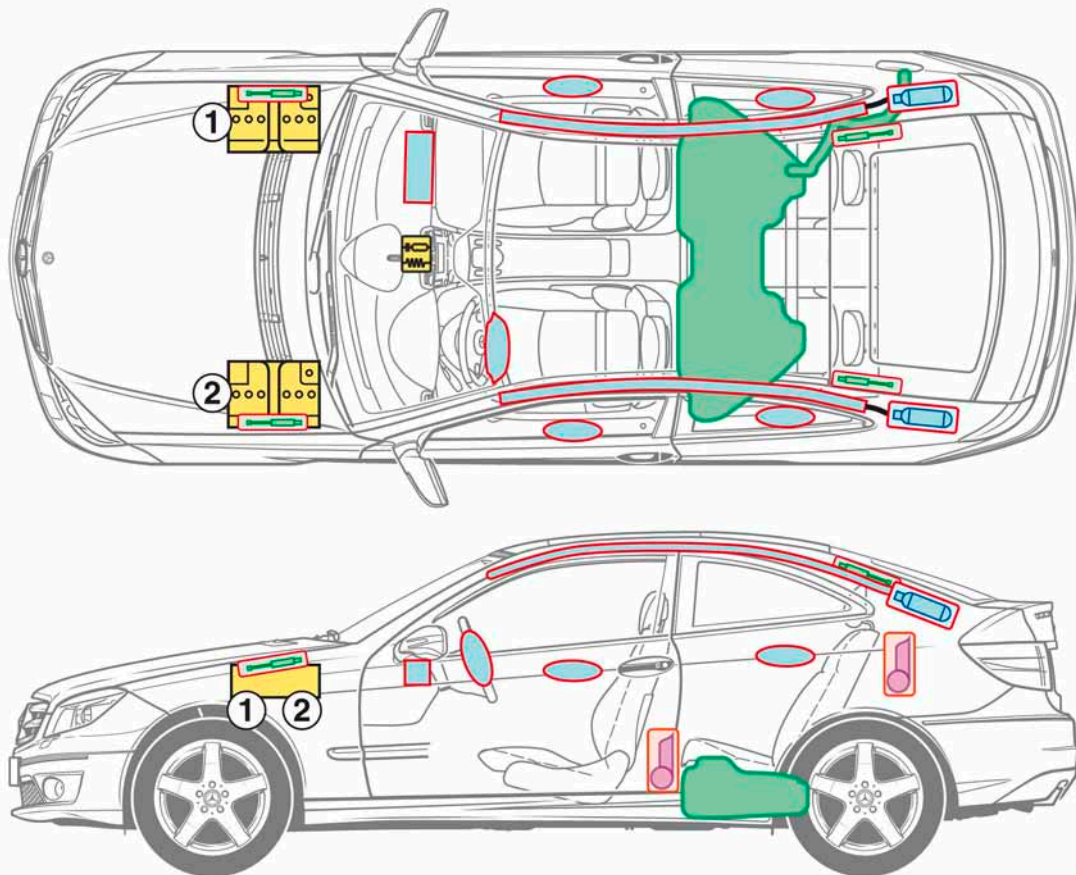

**CLC-Class
Coupé
Model 203**

as of 2008

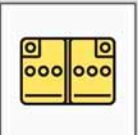
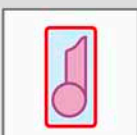
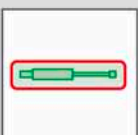

- 1 LHD vehicle
- 2 RHD vehicle

Legend

	Airbag		Structural reinforcements		Control unit
	Gas generator		Rollover protection		Battery
	Seat belt tensioner		Gas filled spring device		Fuel tank

**C-Class
Coupe
Model 204**



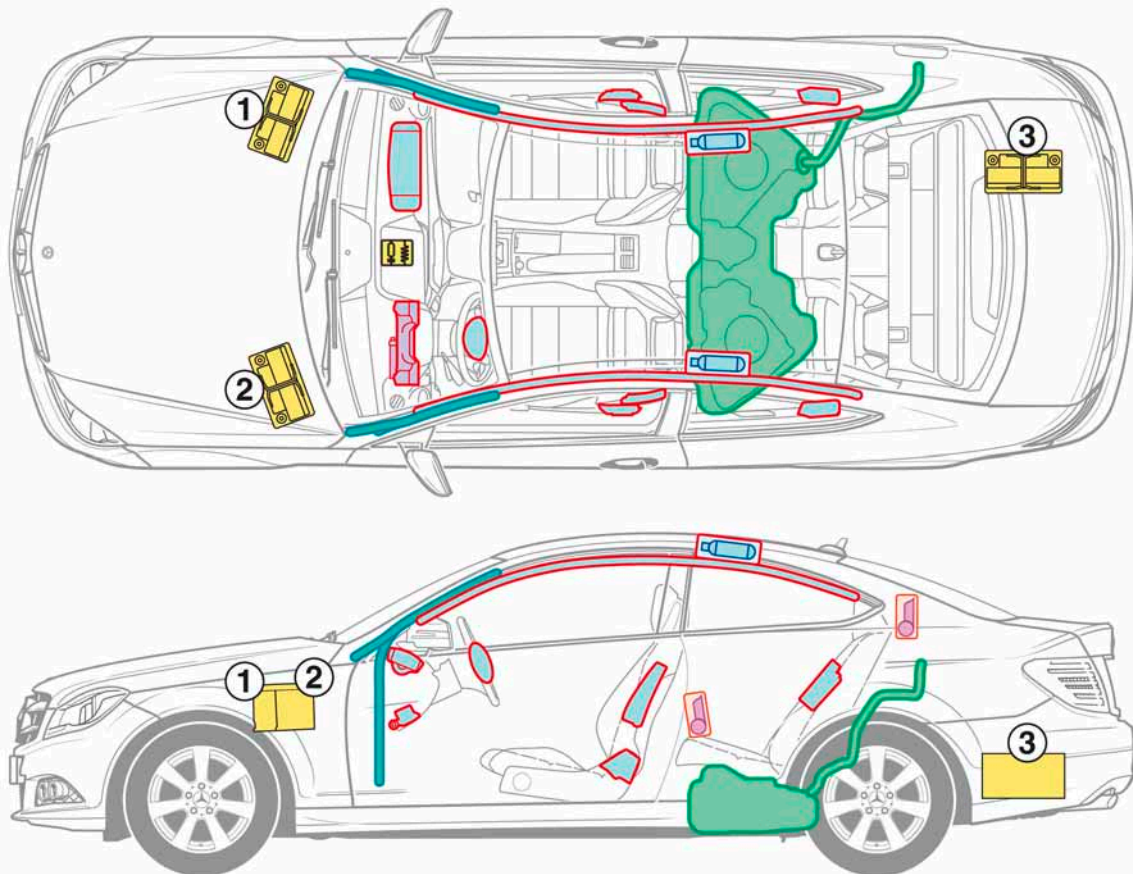



as of 2011



1 Power supply battery, LHD
2 Power supply battery, RHD

3 Additional battery

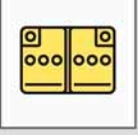
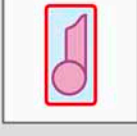
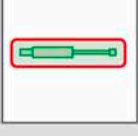
Legend





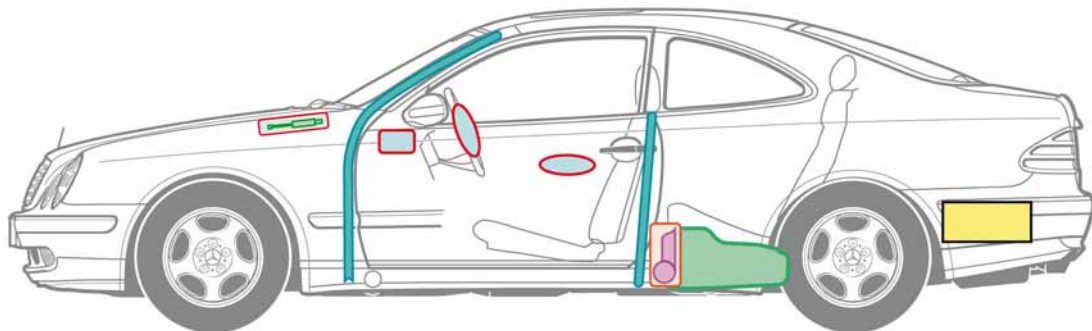
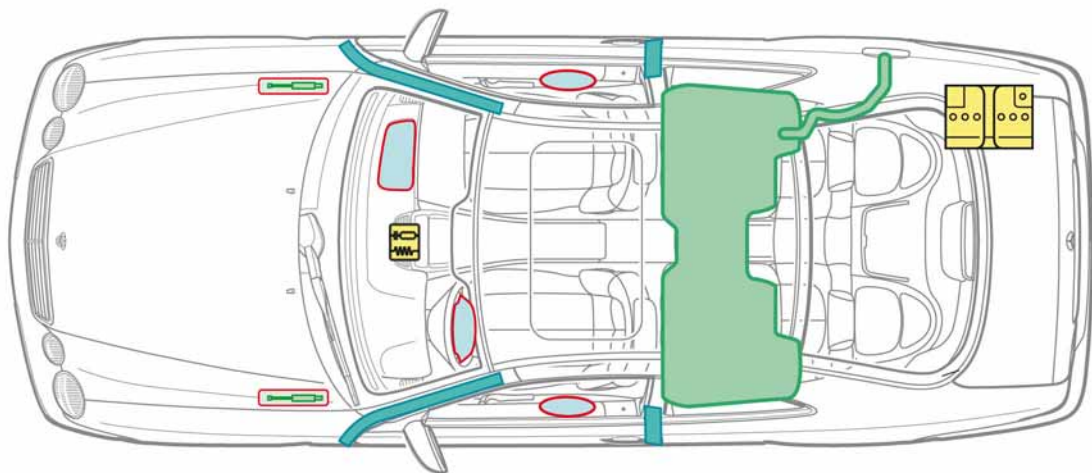

	Airbag		Structural reinforcements		Control unit
	Gas generator		Rollover protection		Battery
	Seat belt tensioner		Gas filled spring device		Fuel tank

**CLK-Class
Coupé
Model 208**

1997-2002

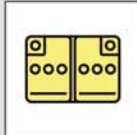
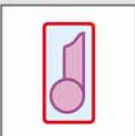
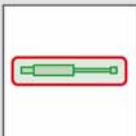

Legend

	Airbag		Structural reinforcements		Control unit
	Gas generator		Rollover protection		Battery
	Seat belt tensioner		Gas filled spring device		Fuel tank





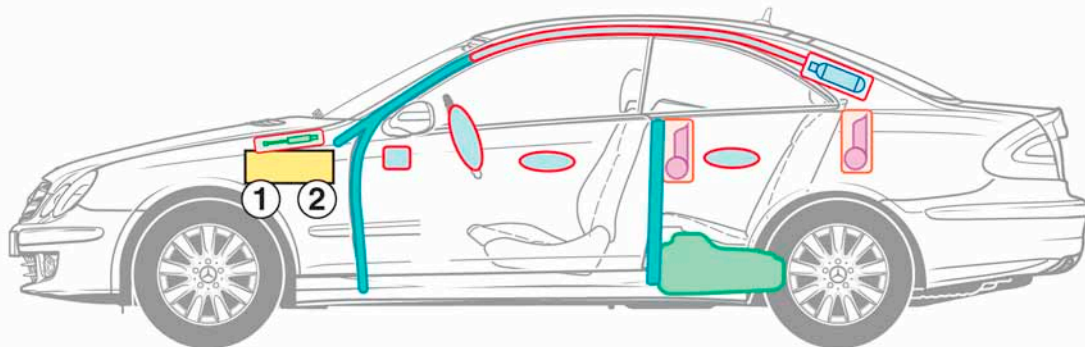
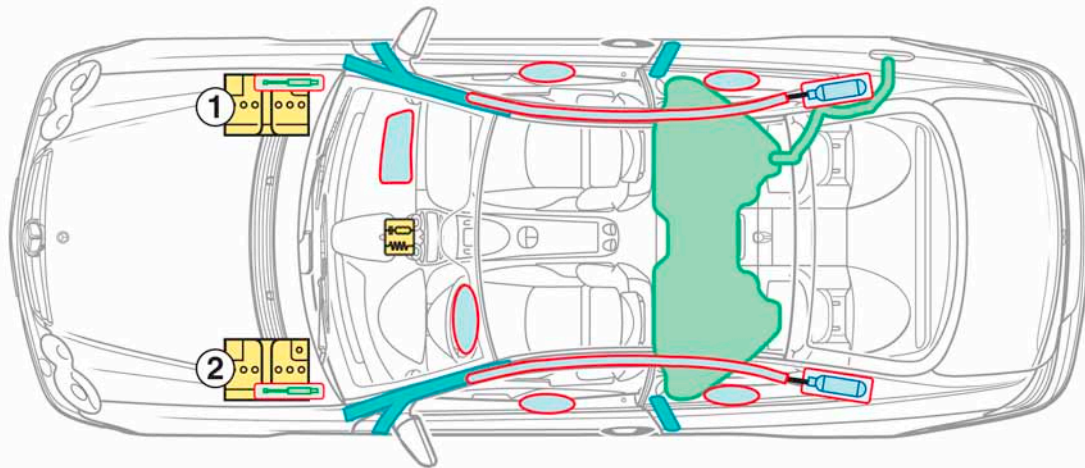

**CLK-Class
Coupé
Model 209**

2002-2009

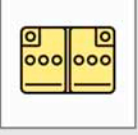
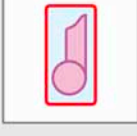
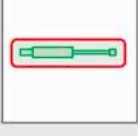

1 LHD vehicle
2 RHD vehicle

Legend





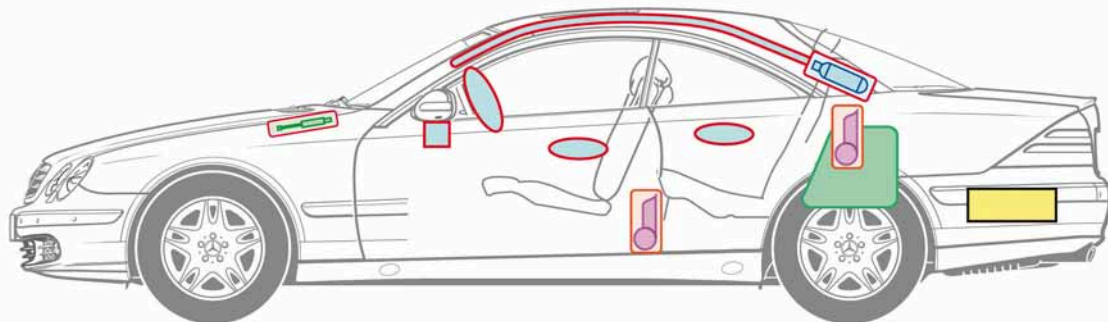
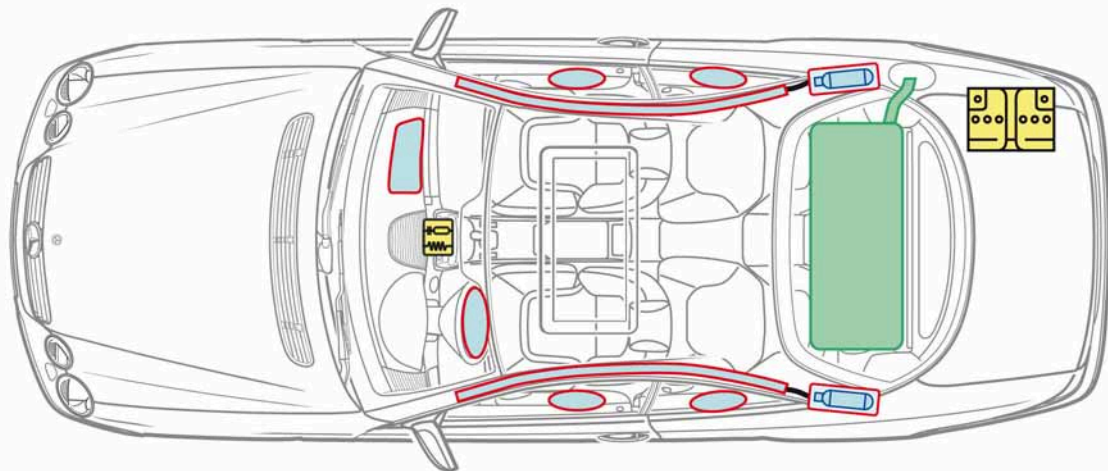

	Airbag		Structural reinforcements		Control unit
	Gas generator		Rollover protection		Battery
	Seat belt tensioner		Gas filled spring device		Fuel tank

**CL-Class
Coupé
Model 215**

1999-2006

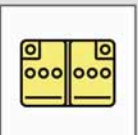
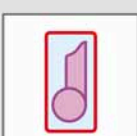
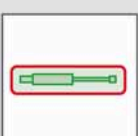

Legend

	Airbag		Structural reinforcements		Control unit
	Gas generator		Rollover protection		Battery
	Seat belt tensioner		Gas filled spring device		Fuel tank





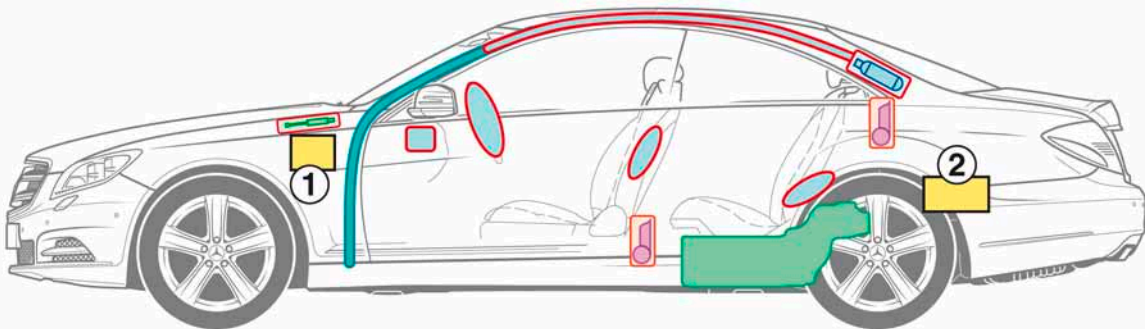
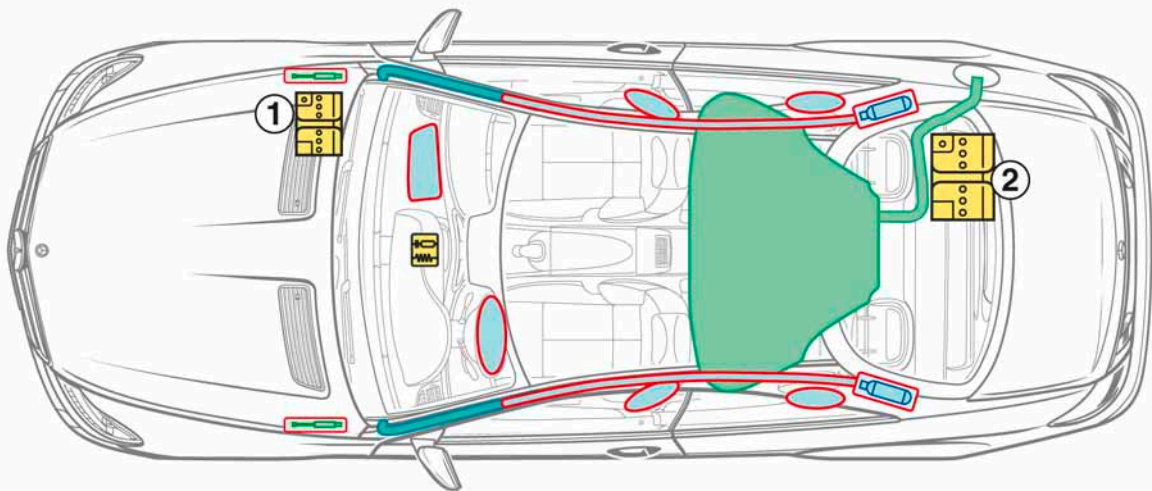

**CL-Class
Coupé
Model 216**

ab 2006

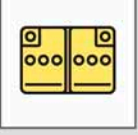
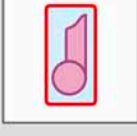
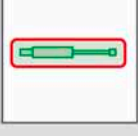

- 1 Starter byttery (engine compartment)
- 2 Power supply battery (trunk)

Legend

	Airbag		Structural reinforcements		Control unit
	Gas generator		Rollover protection		Battery
	Seat belt tensioner		Gas filled spring device		Fuel tank

**CLS-Class
Coupé
Model 219**



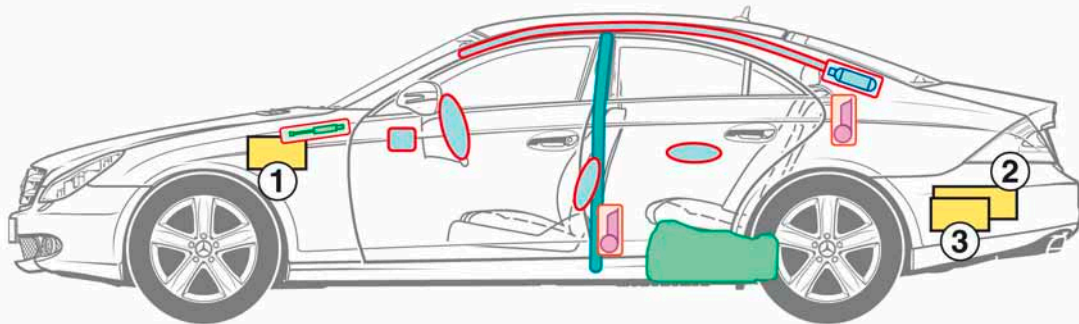
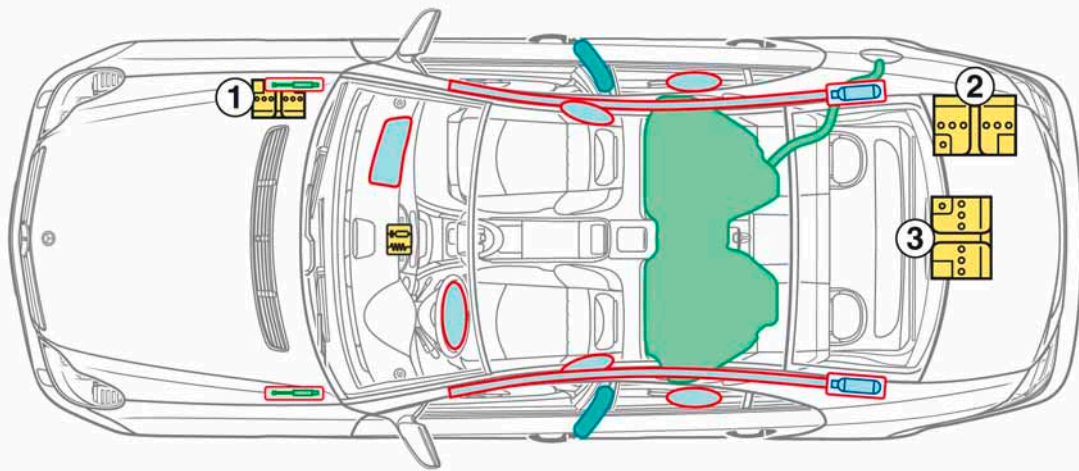



2004-2009



1 Additional battery (engine compartment)
2 Main battery (equipment with spare wheel)

3 Main battery (equipment without spare wheel)

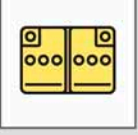
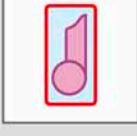
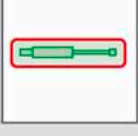
Legend

	Airbag		Structural reinforcements		Control unit
	Gas generator		Roll-over protection		Battery
	Seat belt tensioner		Gas filled spring device		Fuel tank





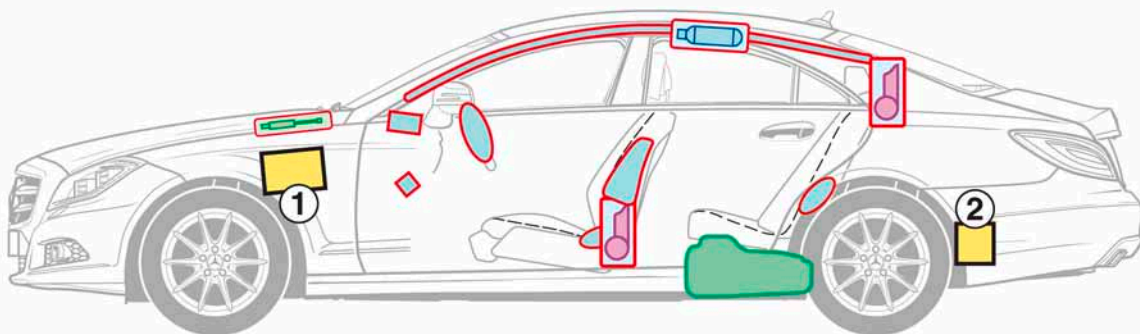
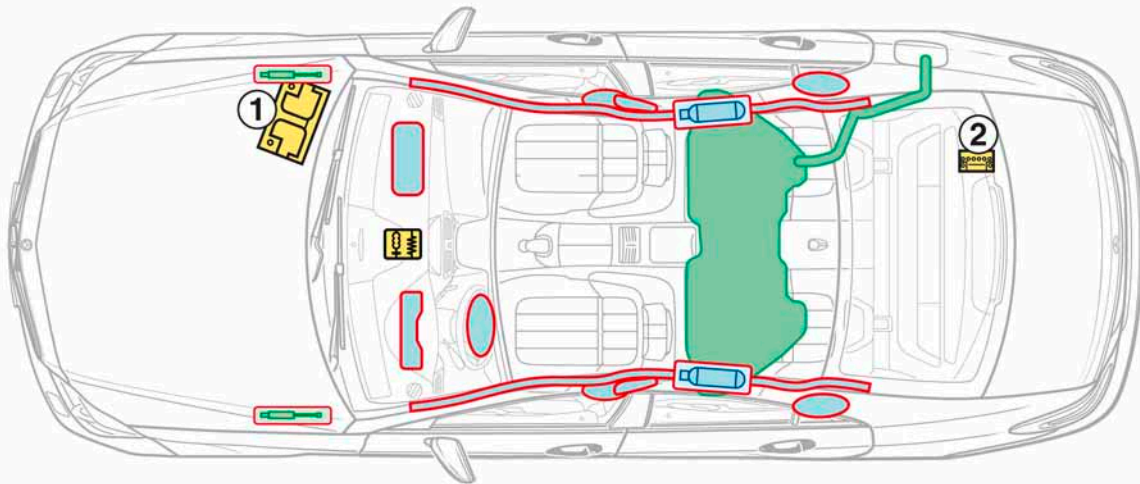

**CLS-Class
Coupe
Model 218**

as of 2010

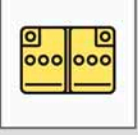
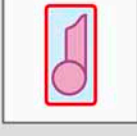
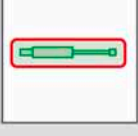

- 1 Power supply battery
- 2 Additional battery

Legend

	Airbag		Structural reinforcements		Control unit
	Gas generator		Rollover protection		Battery
	Seat belt tensioner		Gas filled spring device		Fuel tank





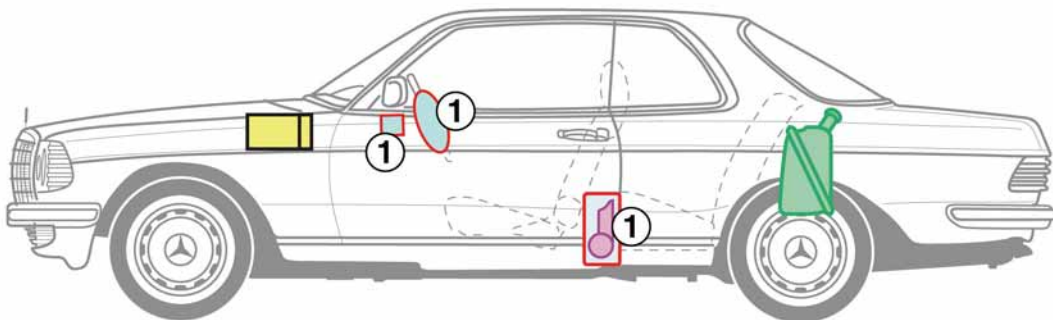
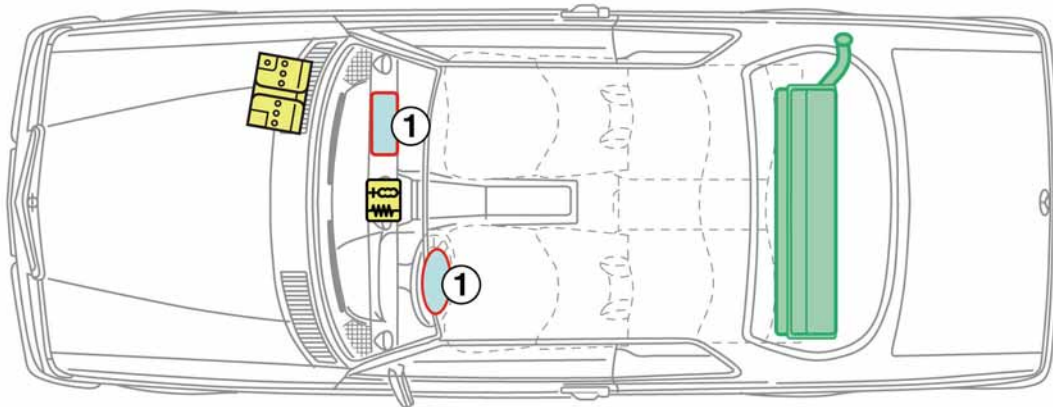

**E-Class
Coupé
Model 123**

1977-1985

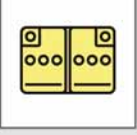
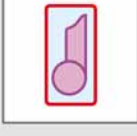
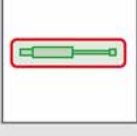

1 as of 1980

Legend

	Airbag		Structural reinforcements		Control unit
	Gas generator		Rollover protection		Battery
	Seat belt tensioner		Gas filled spring device		Fuel tank





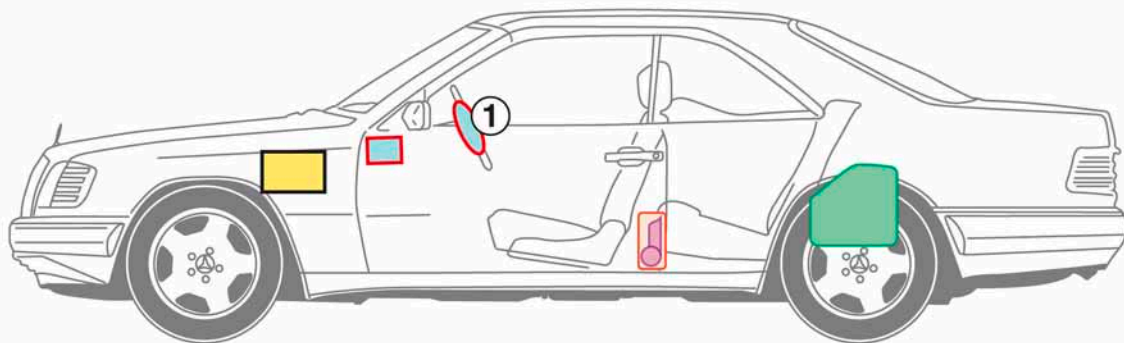
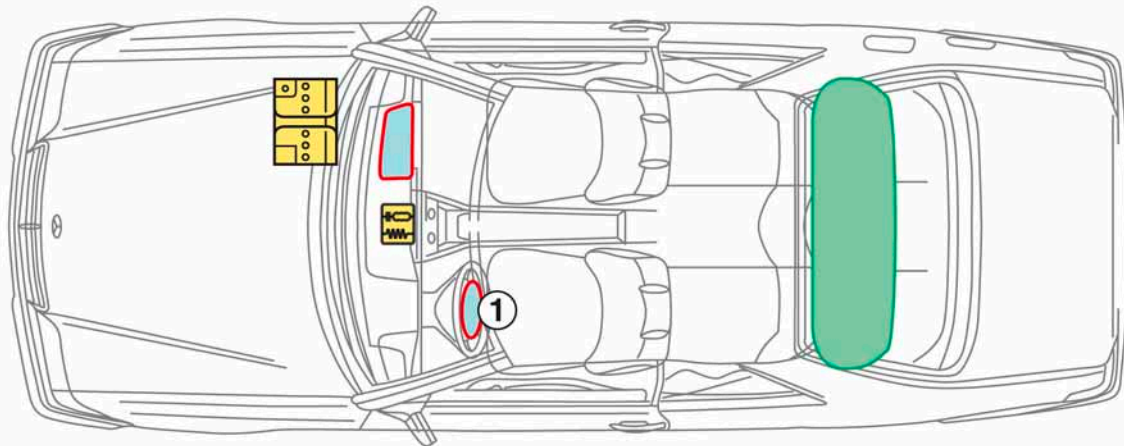

**E-Class
Coupé
Model 124**

1987-1997

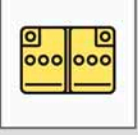
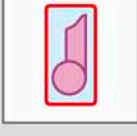
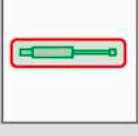

1 Standard as of 1992

Legend

	Airbag		Structural reinforcements		Control unit
	Gas generator		Rollover protection		Battery
	Seat belt tensioner		Gas filled spring device		Fuel tank

**E-Class
Coupe
Model 207**

as of 2009

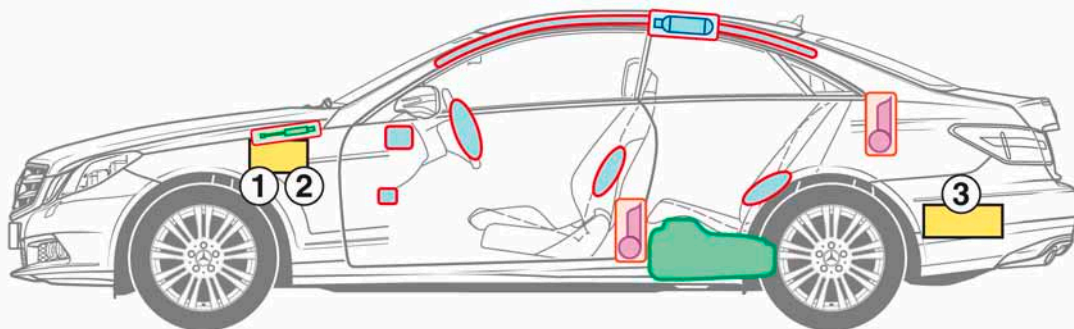
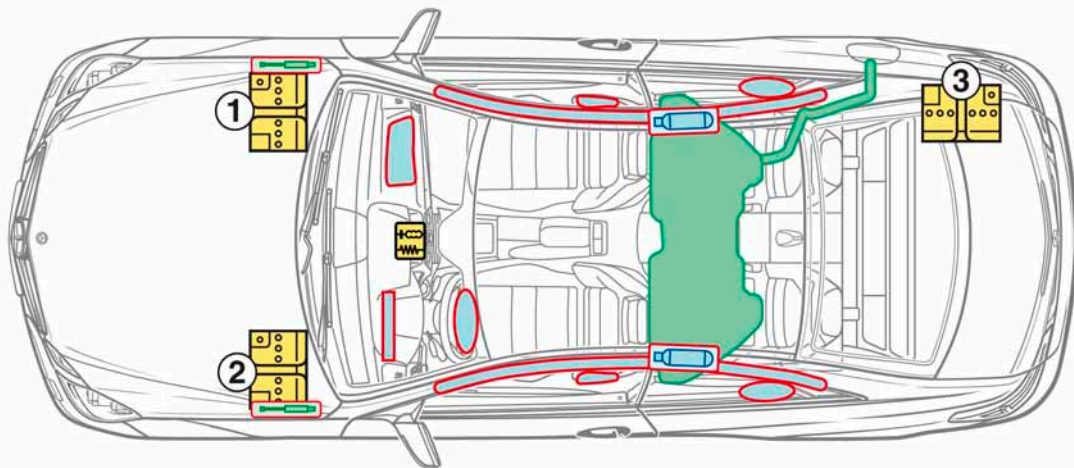

1 Battery in engine compartment
(with 4- and 6-cylinder engine, LHD)

2 Battery in engine compartment
(with 4- and 6-cylinder engine, RHD)

3 Battery in trunk (with 8-cylinder engine)

Legend

	Airbag		Structural reinforcements		Control unit
	Gas generator		Rollover protection		Battery
	Seat belt tensioner		Gas filled spring device		Fuel tank





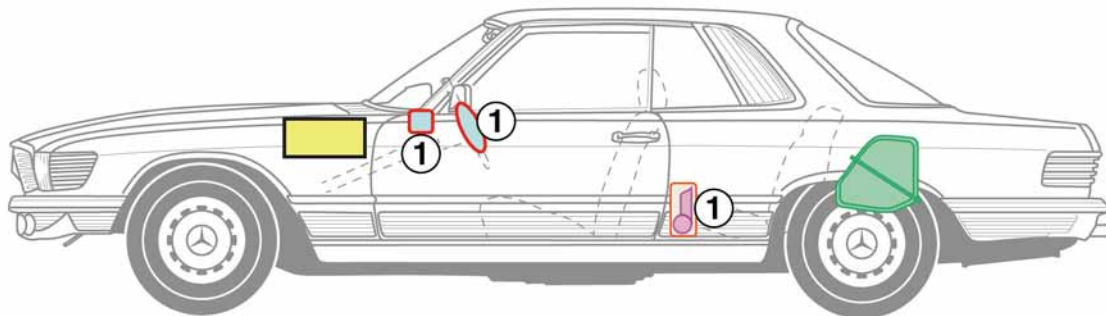
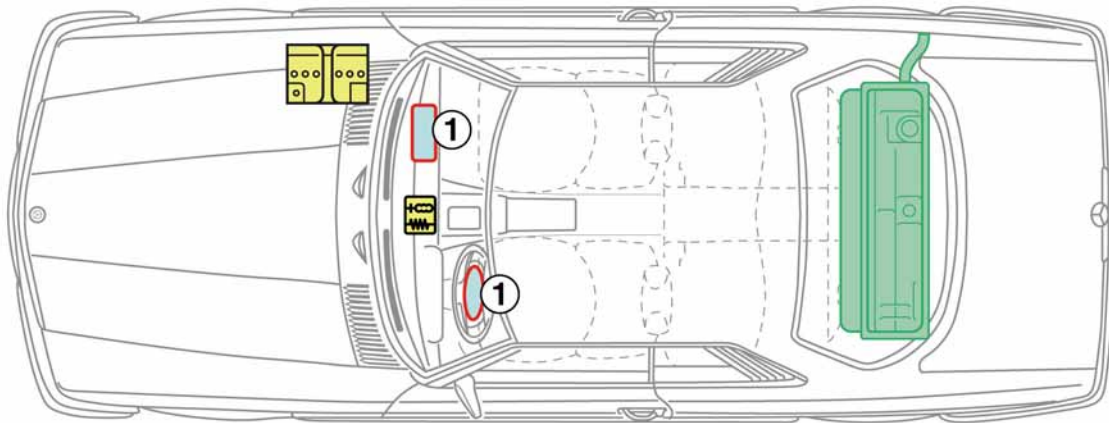

**SLC-Class
Coupé
Model 107**

1971-1989

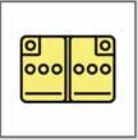
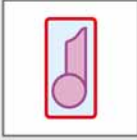

1 as of 1982

Legend







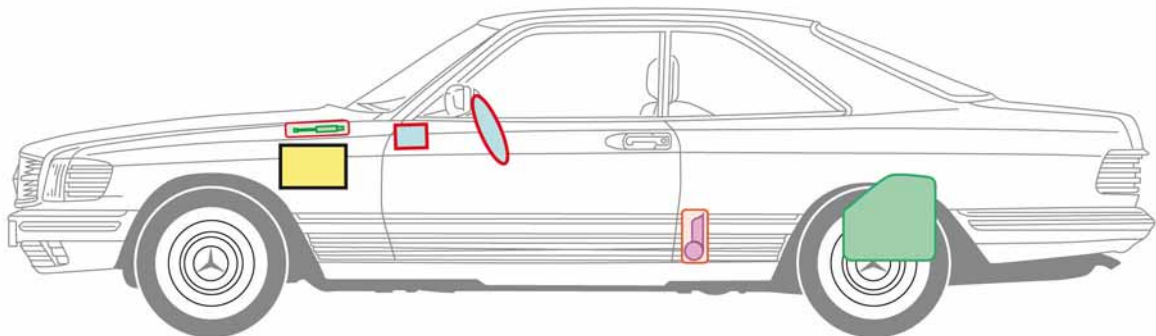
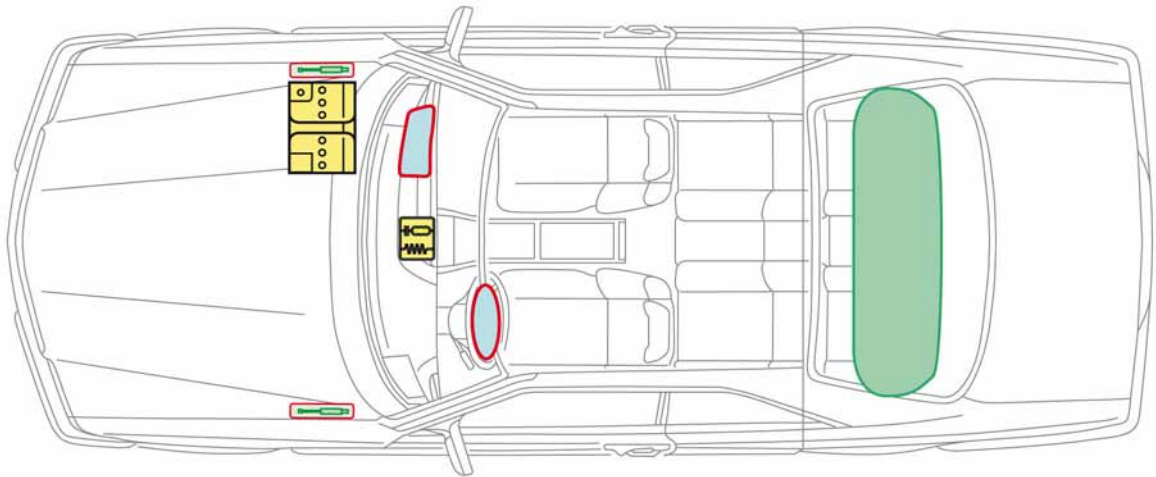

	Airbag		Structural reinforcements		Control unit
	Gas generator		Rollover protection		Battery
	Seat belt tensioner		Gas filled spring device		Fuel tank

**S-Class
Coupé
Model 126**

1981-1991

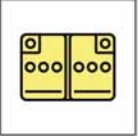

Legend

	Airbag		Structural reinforcements		Control unit
	Gas generator		Rollover protection		Battery
	Seat belt tensioner		Gas filled spring device		Fuel tank





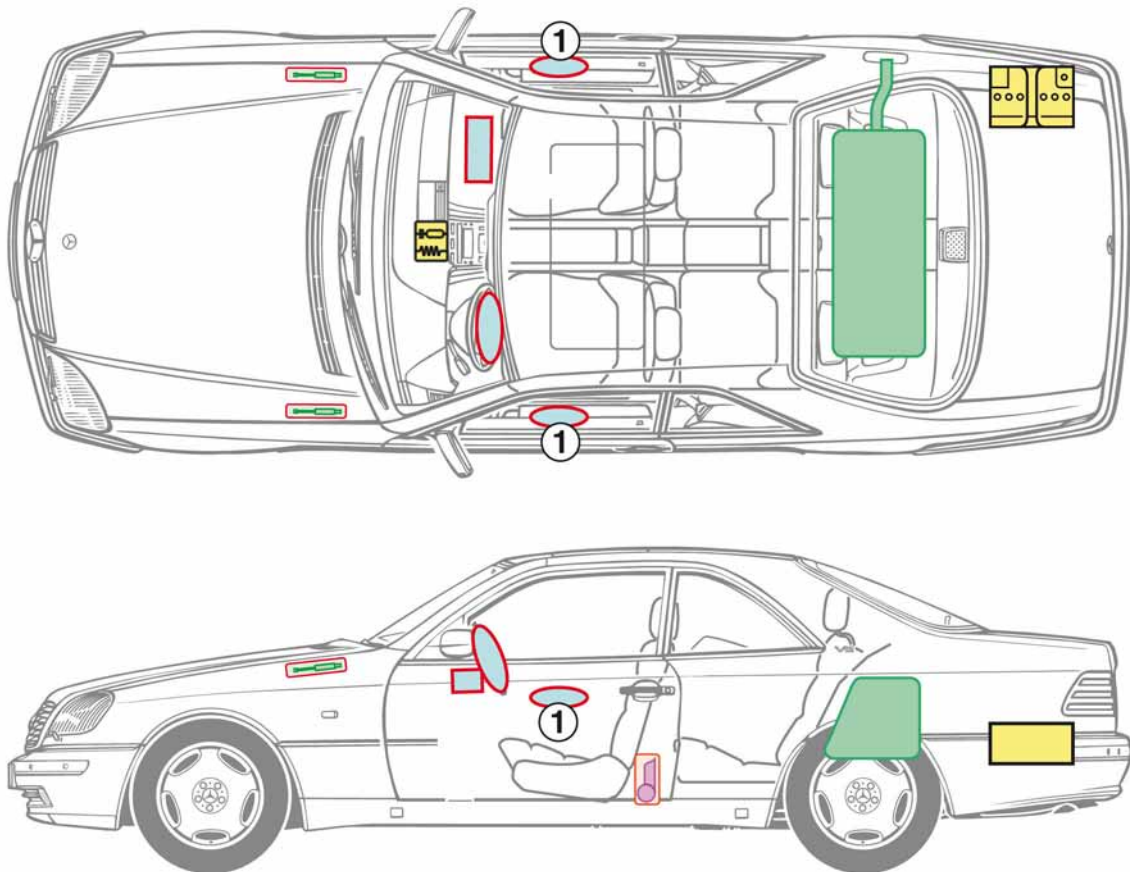



**S-Class
Coupé
Model 140**

1992-1998

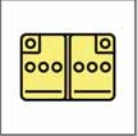

1 Special equipment

Legend





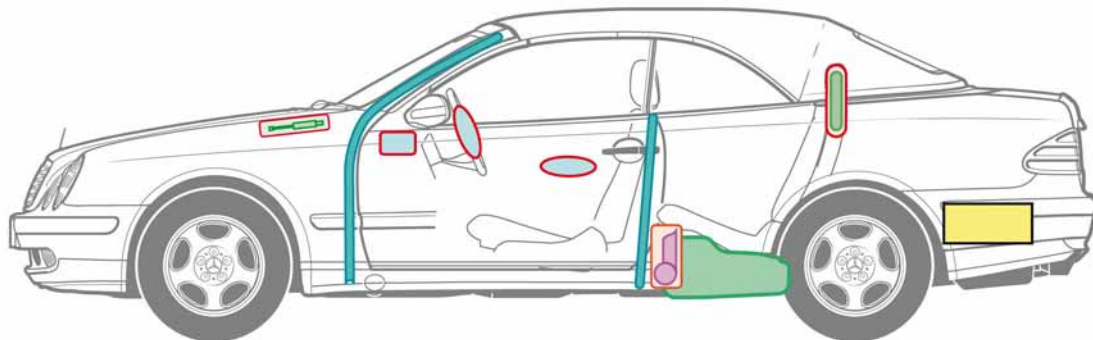
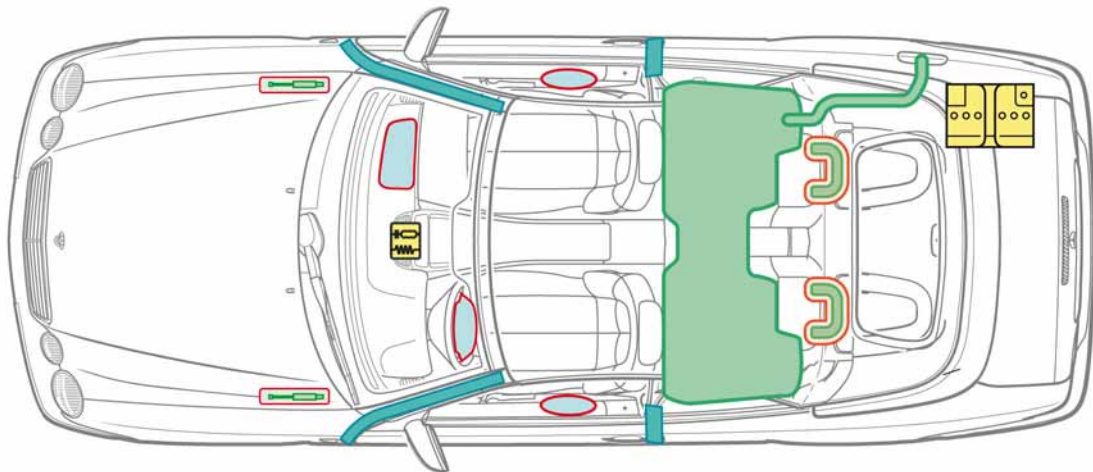

	Airbag		Structural reinforcements		Control unit
	Gas generator		Rollover protection		Battery
	Seat belt tensioner		Gas filled spring device		Fuel tank

**CLK-Class
Cabriolet
Model 208**

1997-2002

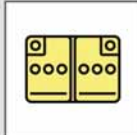
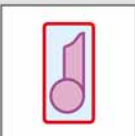
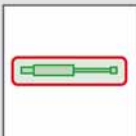

Legend

	Airbag		Structural reinforcements		Control unit
	Gas generator		Rollover protection		Battery
	Seat belt tensioner		Gas filled spring device		Fuel tank





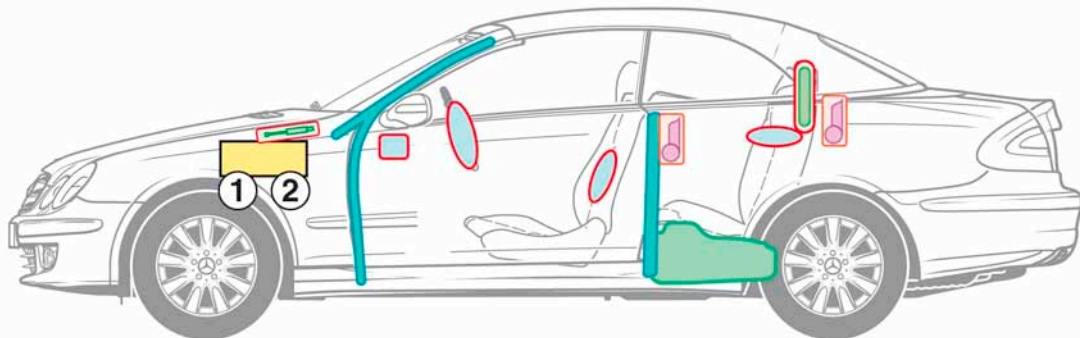
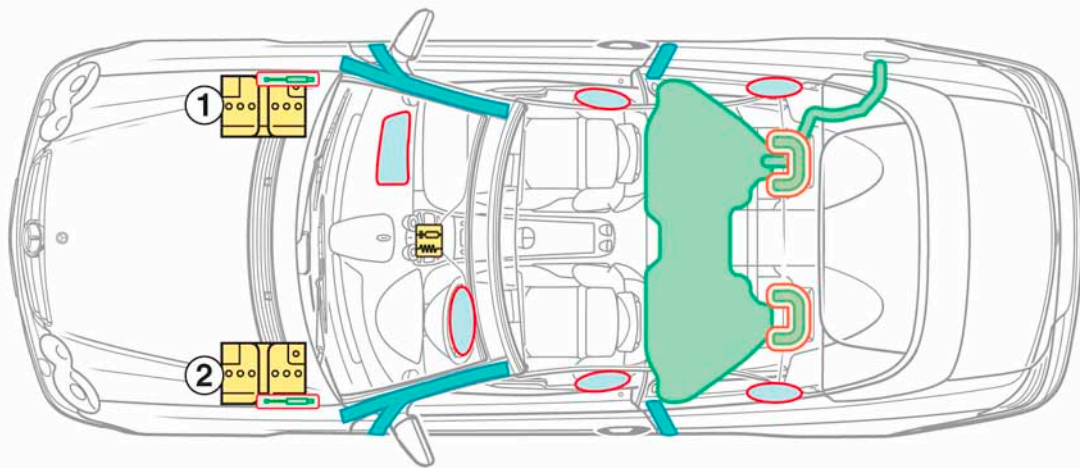

**CLK-Class
Cabriolet
Model 209**

2003-2009

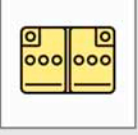
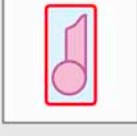
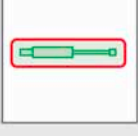

1 LHD vehicle
2 RHD vehicle

Legend





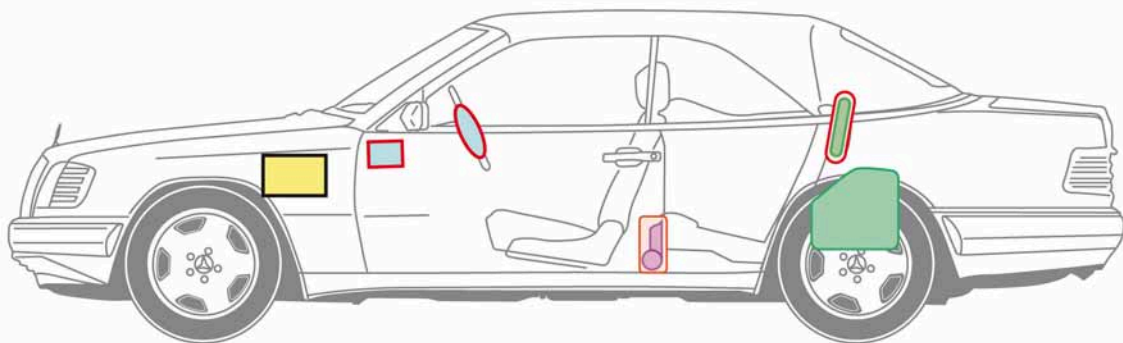
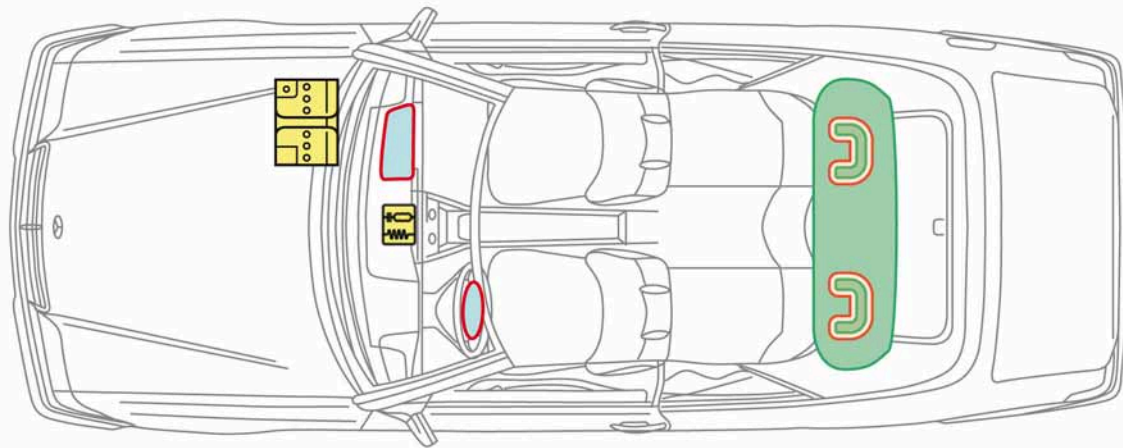

	Airbag		Structural reinforcements		Control unit
	Gas generator		Rollover protection		Battery
	Seat belt tensioner		Gas filled spring device		Fuel tank

**E-Class
Cabriolet
Model 124**

1987-1997

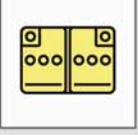
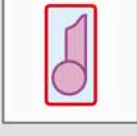
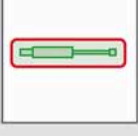

Legend

	Airbag		Structural reinforcements		Control unit
	Gas generator		Rollover protection		Battery
	Seat belt tensioner		Gas filled spring device		Fuel tank

**E-Class
Cabriolet
Model 207**

as of 2010

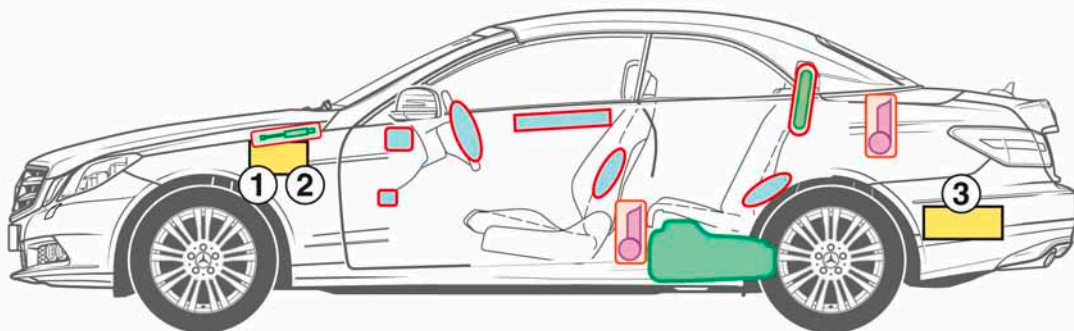
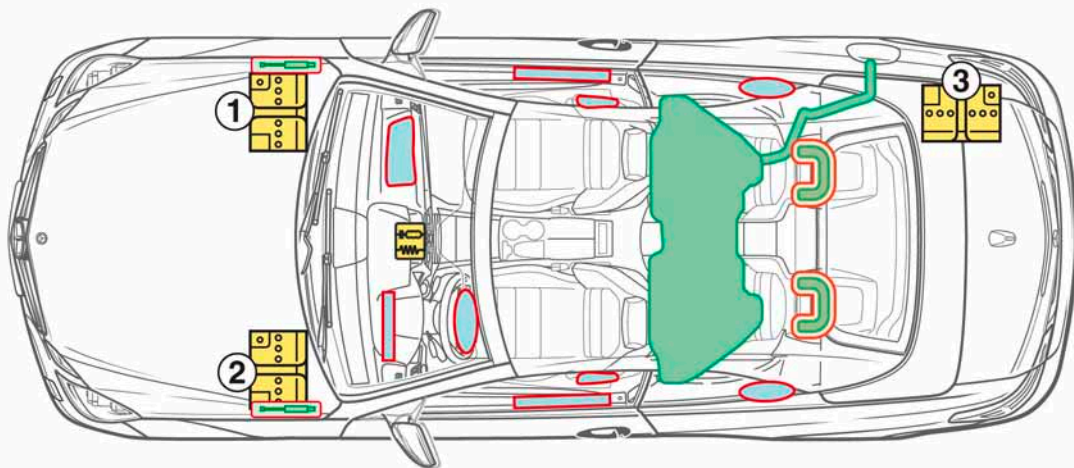







1 Battery in engine compartment
(with 4- and 6-cylinder engine, LHD)

2 Battery in engine compartment
(with 4- and 6-cylinder engine, RHD)

3 Battery in trunk (with 8-cylinder engine)

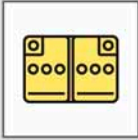
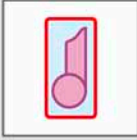
Legend

	Airbag		Structural reinforcements		Control unit
	Gas generator		Rollover protection		Battery
	Seat belt tensioner		Gas filled spring device		Fuel tank





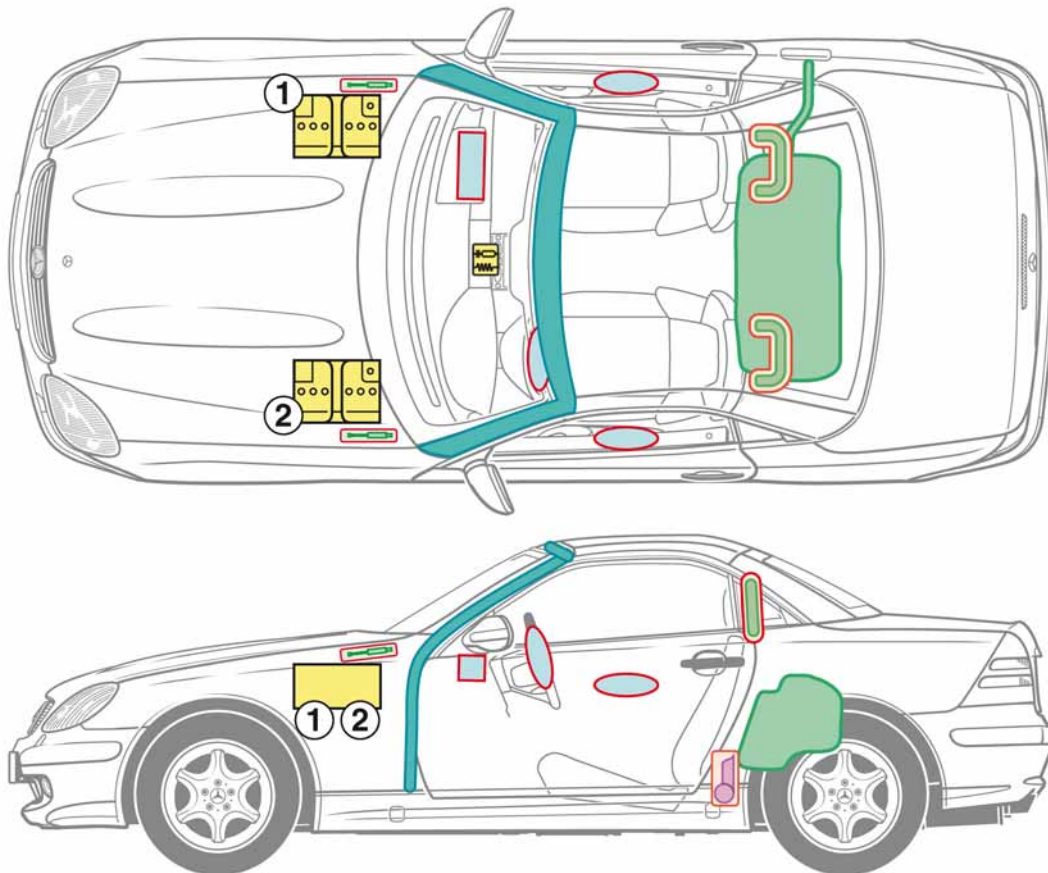

**SLK-Class
Roadster
Model 170**

1996-2004

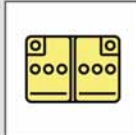
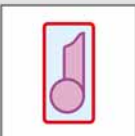
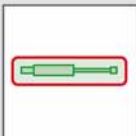

1 LHD vehicle
2 RHD vehicle

Legend

	Airbag		Structural reinforcements		Control unit
	Gas generator		Rollover protection		Battery
	Seat belt tensioner		Gas filled spring device		Fuel tank





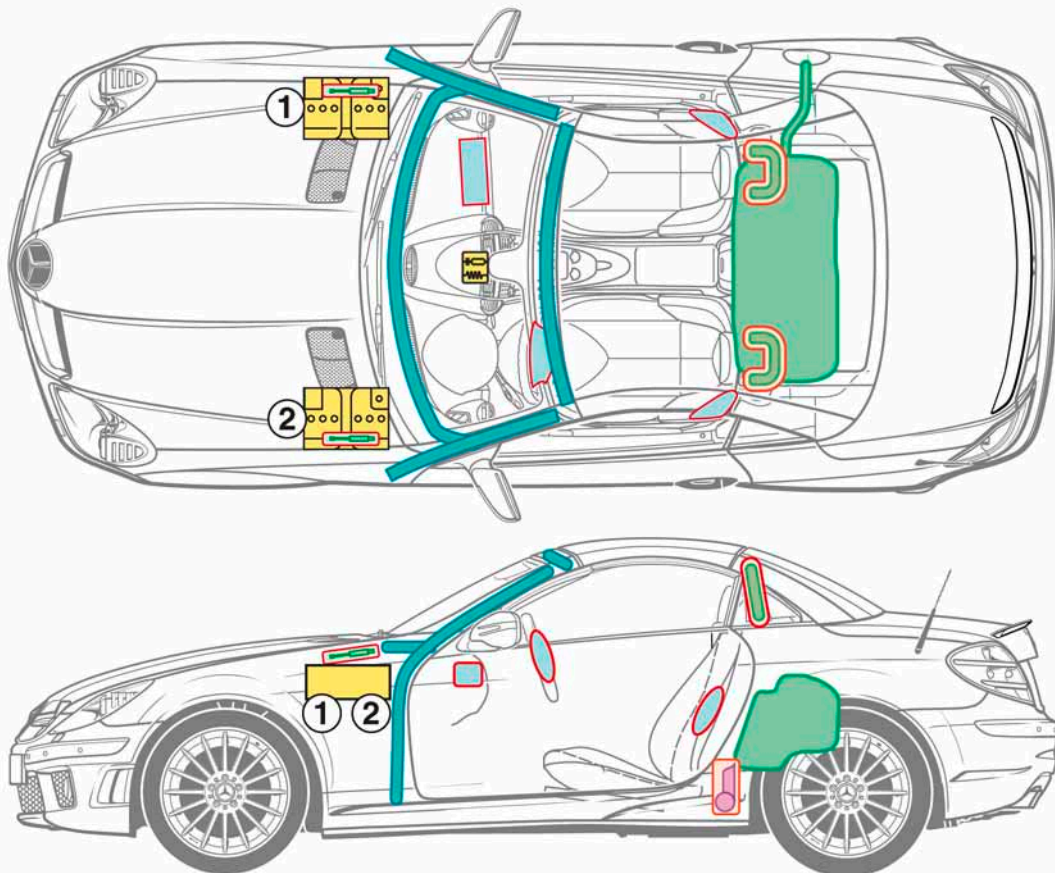

**SLK-Class
Roadster
Model 171**

as of 2004

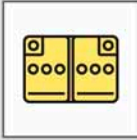
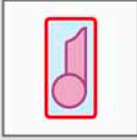

1 LHD vehicle
2 RHD vehicle

Legend

	Airbag		Structural reinforcements		Control unit
	Gas generator		Rollover protection		Battery
	Seat belt tensioner		Gas filled spring device		Fuel tank

**SLK-Class
Roadster
Model 172**



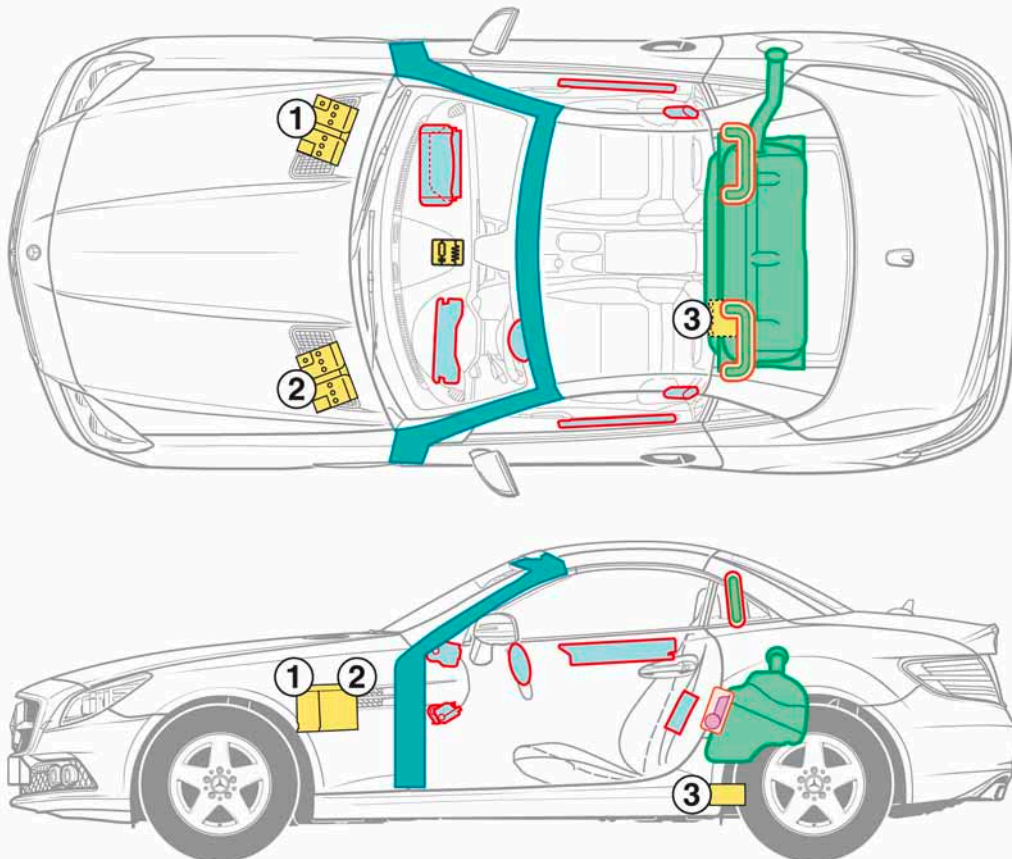





as of 2011



1 Power supply battery, LHD
2 Power supply battery, RHD

3 Additional battery ECO Start-Stopp

Legend

	Airbag		Structural reinforcements		Control unit
	Gas generator		Rollover protection		Battery
	Seat belt tensioner		Gas filled spring device		Fuel tank





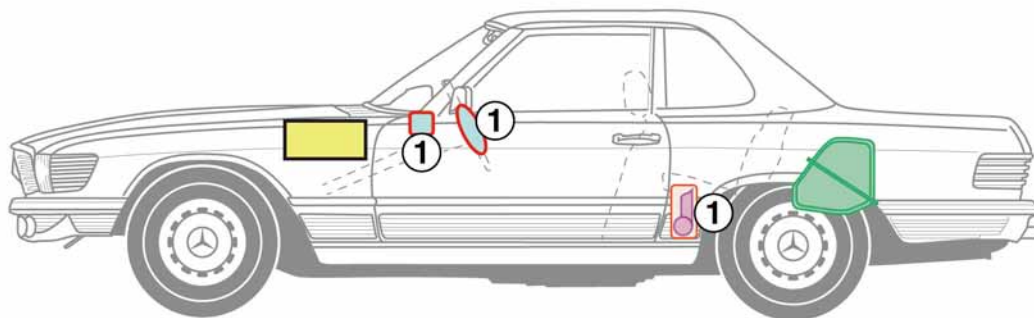
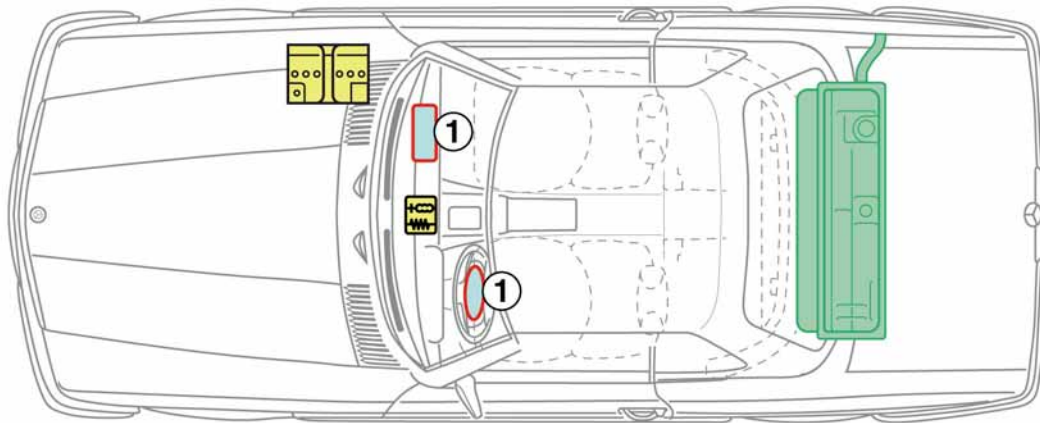

**SL-Class
Roadster
Model 107**

1971-1989

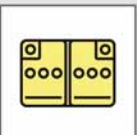
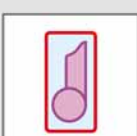
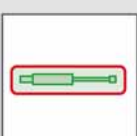

1 as of 1982

Legend







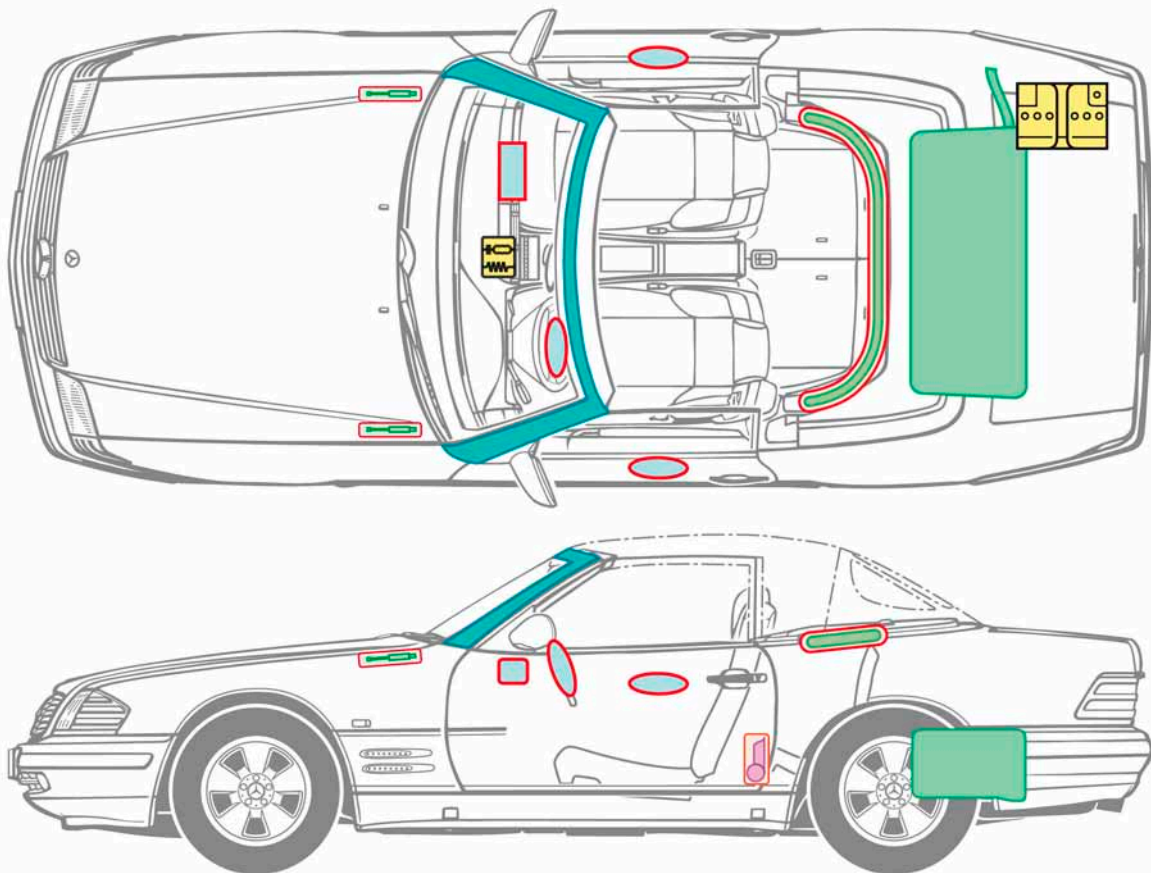

	Airbag		Structural reinforcements		Control unit
	Gas generator		Rollover protection		Battery
	Seat belt tensioner		Gas filled spring device		Fuel tank

**SL-Class
Roadster
Model 129**

1989-2001

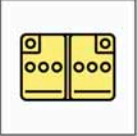

Legend

	Airbag		Structural reinforcements		Control unit
	Gas generator		Rollover protection		Battery
	Seat belt tensioner		Gas filled spring device		Fuel tank

**SL-Class
Roadster
Model 230**



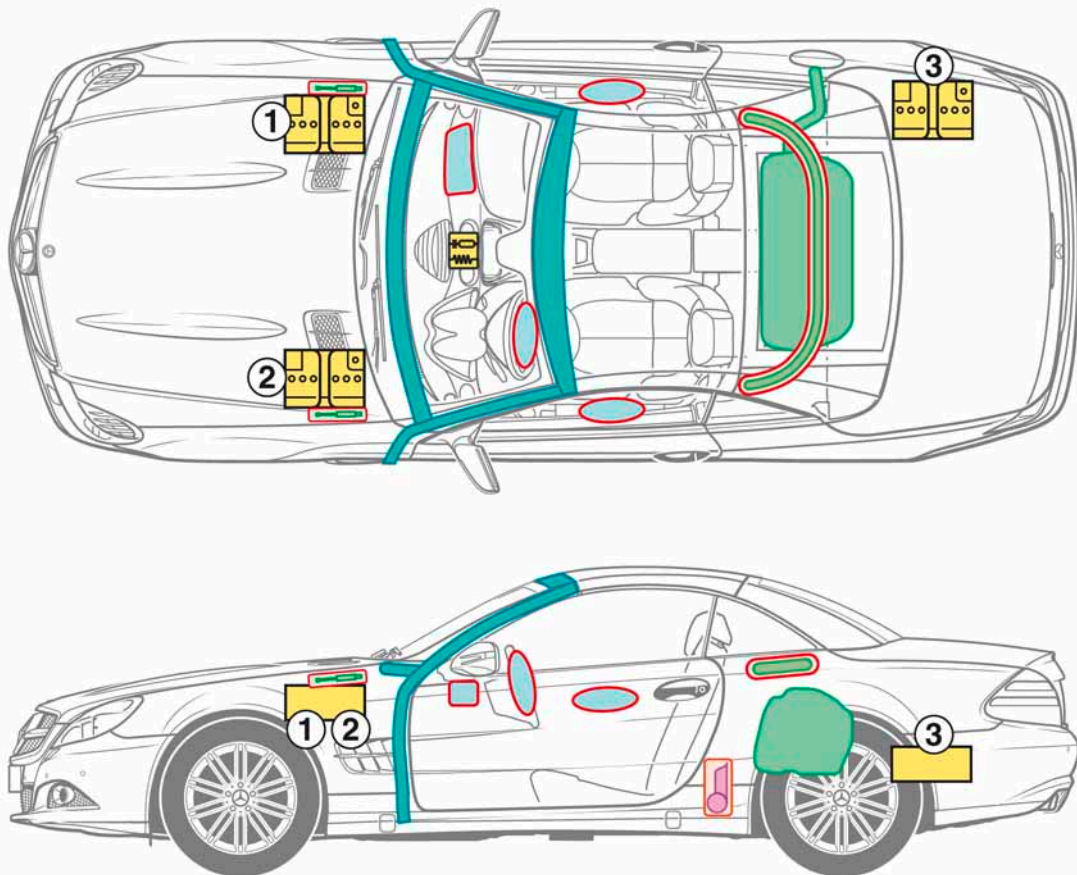





2001-2012



1 Starter battery, LHD
2 Starter batterie, RHD

3 Power supply battery

Legend

	Airbag		Structural reinforcements		Control unit
	Gas generator		Rollover protection		Battery
	Seat belt tensioner		Gas filled spring device		Fuel tank





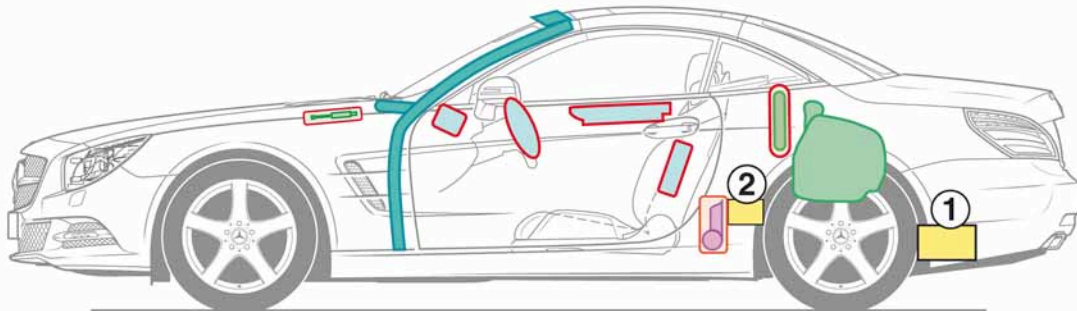
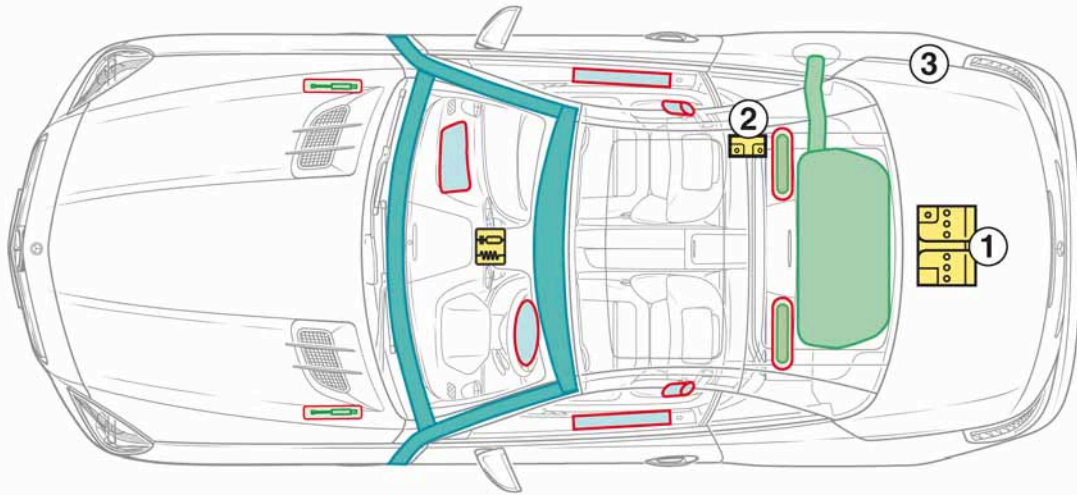



**SL-Class
Roadster
Model 231**

as of 2012

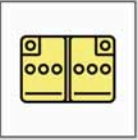

- 1 Power supply battery
- 2 Additional battery ECO Start-Stopp

Legend

	Airbag		Structural reinforcements		Control unit
	Gas generator		Rollover protection		Battery
	Seat belt tensioner		Gas filled spring device		Fuel tank





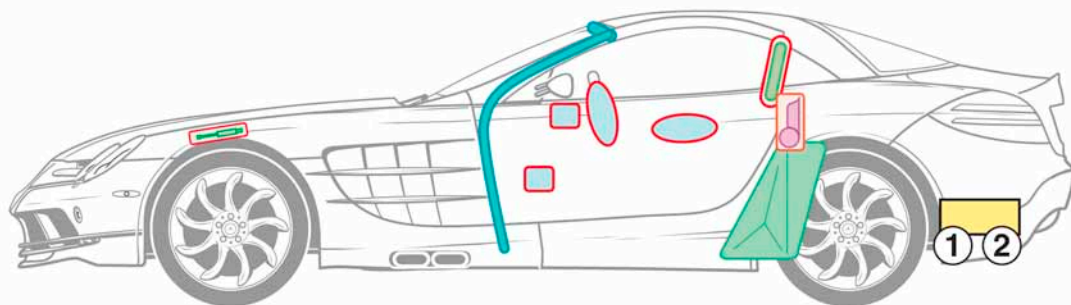
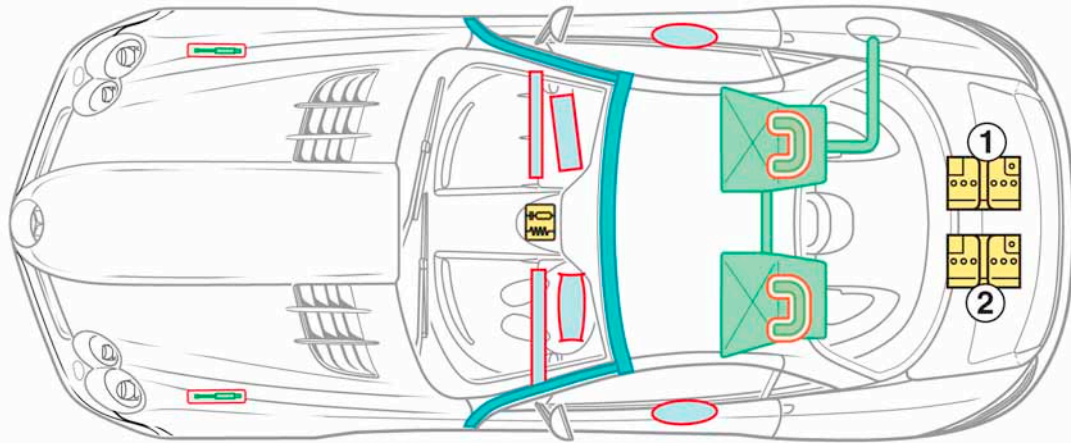

**SLR
McLaren
Model 199**

2004 2009

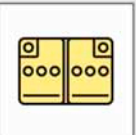
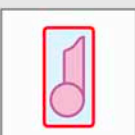
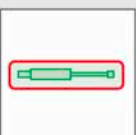

- 1 Starter battery
- 2 Power supply battery

Legend

	Airbag		Structural reinforcements		Control unit
	Gas generator		Roll-over protection		Battery
	Seat belt tensioner		Gas filled spring device		Fuel tank

G-Class
Cross-country
vehicle
Model 463



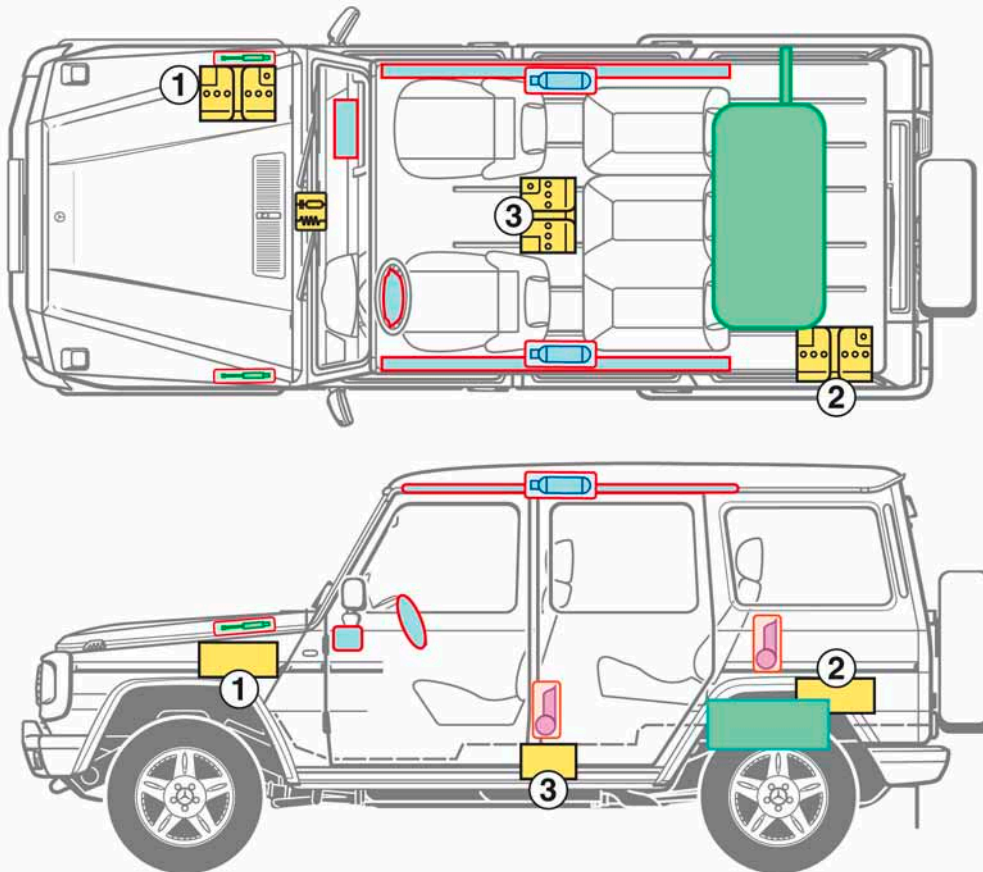



as of 1990



1 up to 09.1996
 2 as of 10.1996 bis 11.2000

3 as of 12.2000

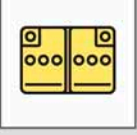
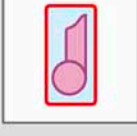
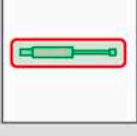
Legend

	Airbag		Structural reinforcements		Control unit
	Gas generator		Rollover protection		Battery
	Seat belt tensioner		Gas filled spring device		Fuel tank

GLK-Class
Cross-country
vehicle
Model 204



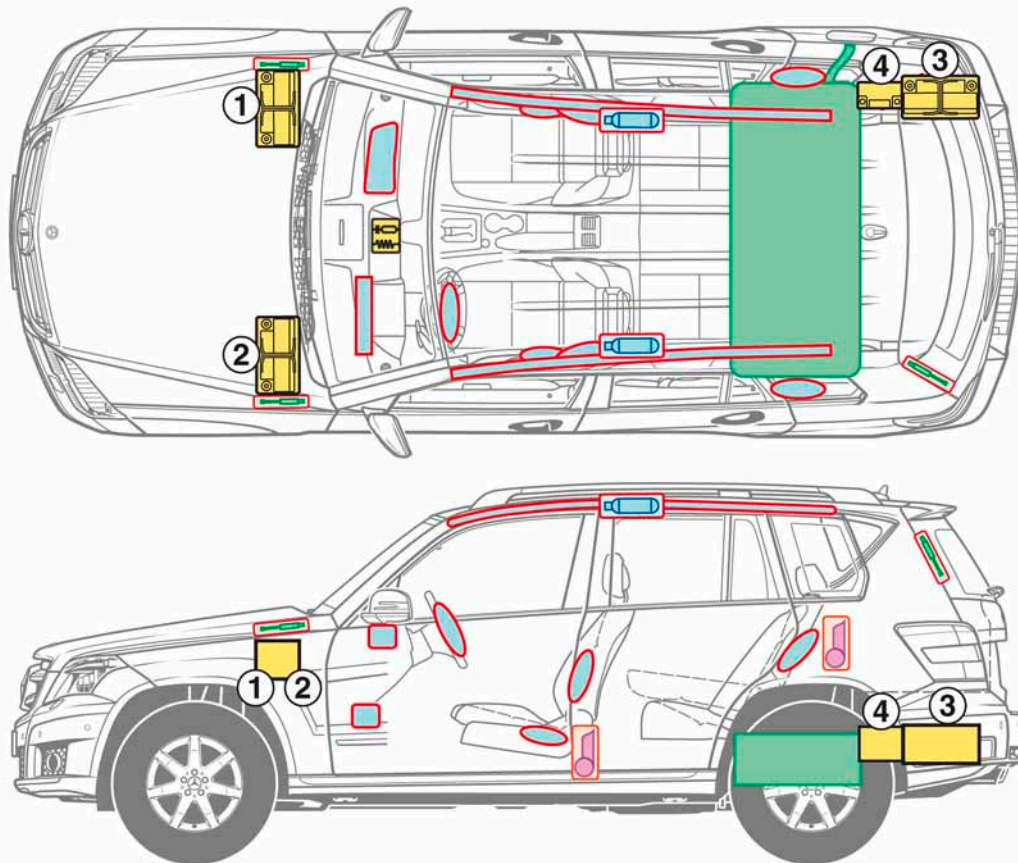



as of 2008



1 LHD vehicle
 2 RHD vehicle

3 Pelvisbag (as of 06.2009)

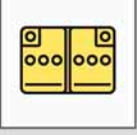
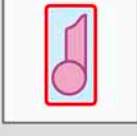
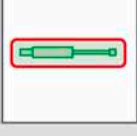
Legend

	Airbag		Structural reinforcements		Control unit
	Gas generator		Rollover protection		Battery
	Seat belt tensioner		Gas filled spring device		Fuel tank





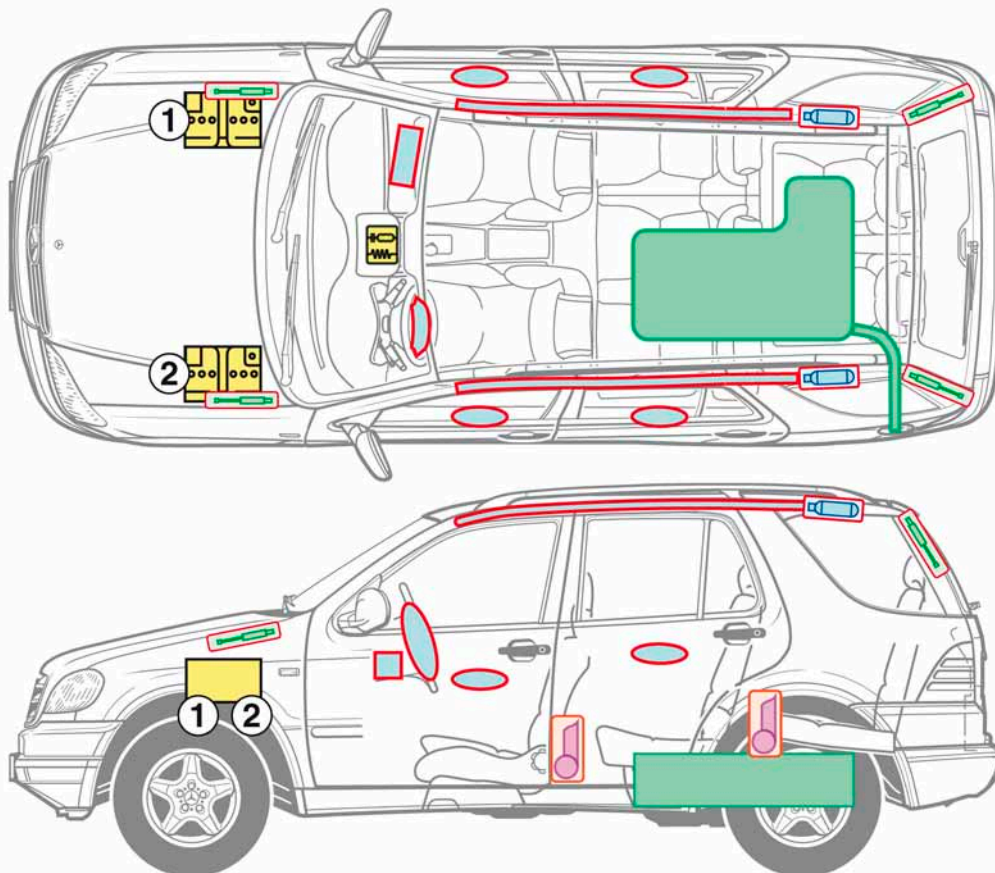

M-Class
Cross-country
vehicle
Model 163

1997-2005

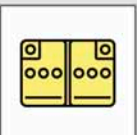
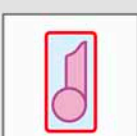
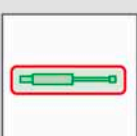

1 LHD vehicle
2 RHD vehicle

Legend

	Airbag		Structural reinforcements		Control unit
	Gas generator		Rollover protection		Battery
	Seat belt tensioner		Gas filled spring device		Fuel tank





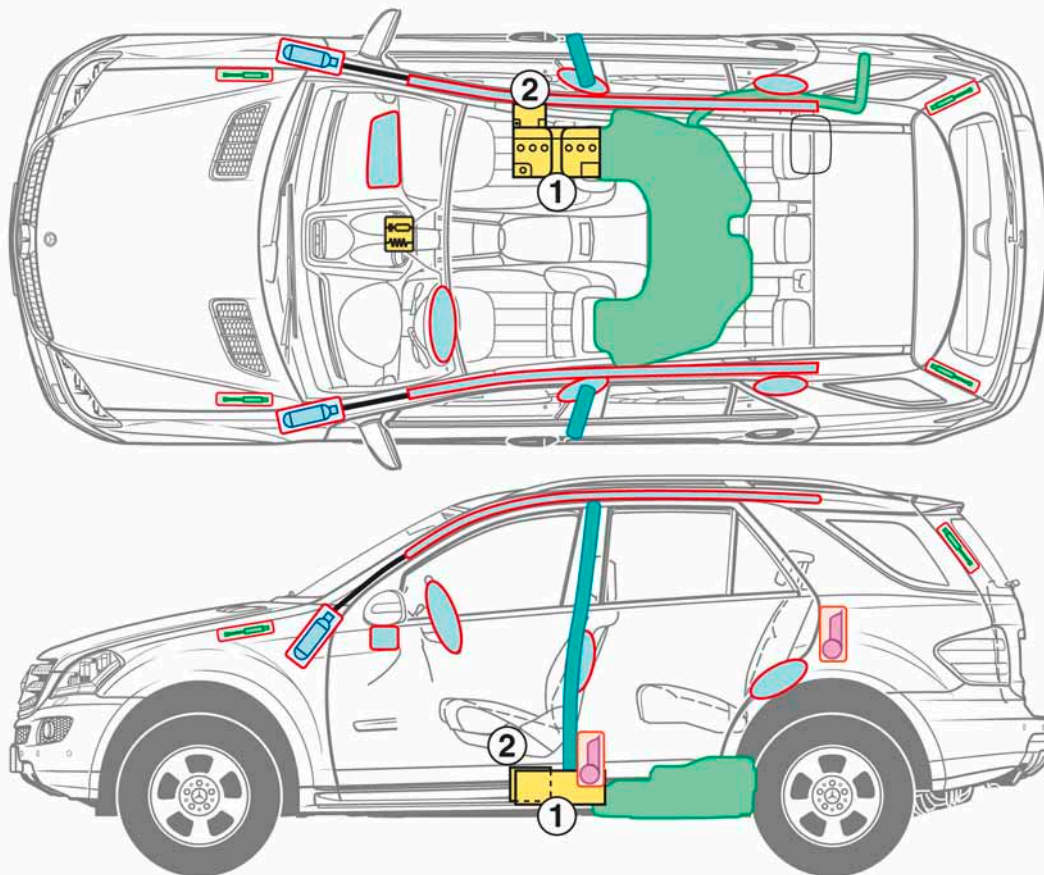



M-Class
Cross-country
vehicle
Model 164

2005-2011

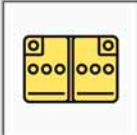

- 1 Main battery
- 2 Additional battery

Legend

	Airbag		Structural reinforcements		Control unit
	Gas generator		Rollover protection		Battery
	Seat belt tensioner		Gas filled spring device		Fuel tank



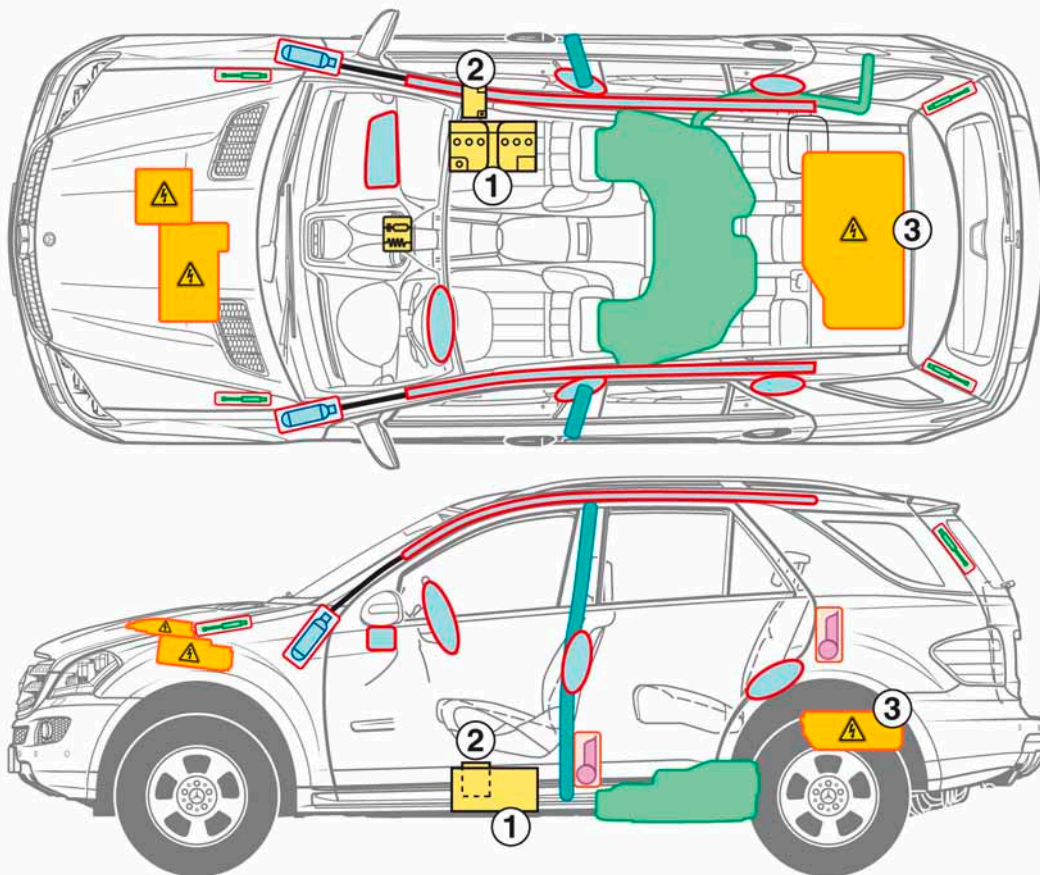



**M-Class
HYBRID**
Cross-country
vehicle
Model 164
as of 2009



1 Main battery
2 Additional battery

3 High-voltage battery

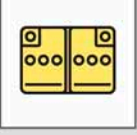
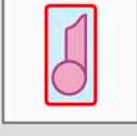
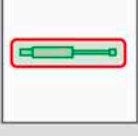
Legend

	Airbag		Structural reinforcements		Control unit
	Gas generator		High-voltage components		Battery
	Seat belt tensioner		Gas filled spring device		Fuel tank





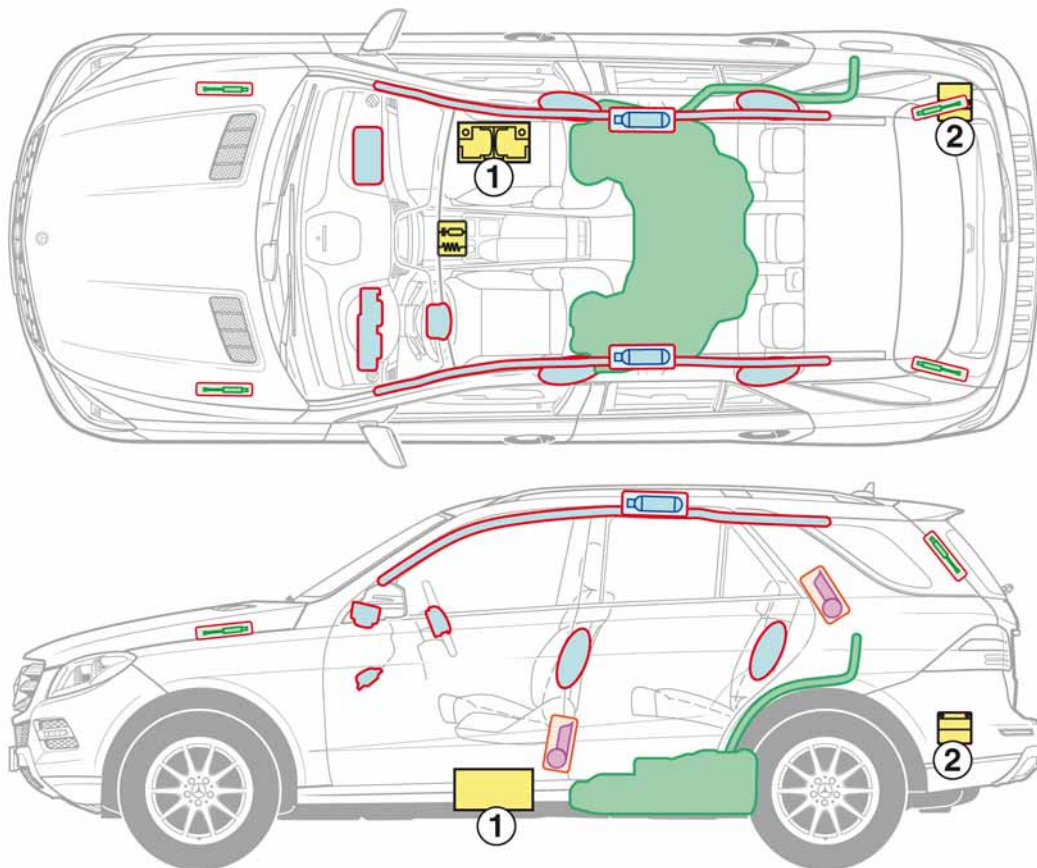

M-Class
Cross-country
vehicle
Model 166

as of 2011

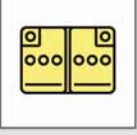
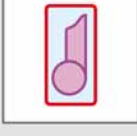
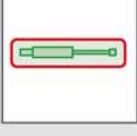

- 1 Main battery
- 2 Additional battery

Legend

	Airbag		Structural reinforcements		Control unit
	Gas generator		Rollover protection		Battery
	Seat belt tensioner		Gas filled spring device		Fuel tank





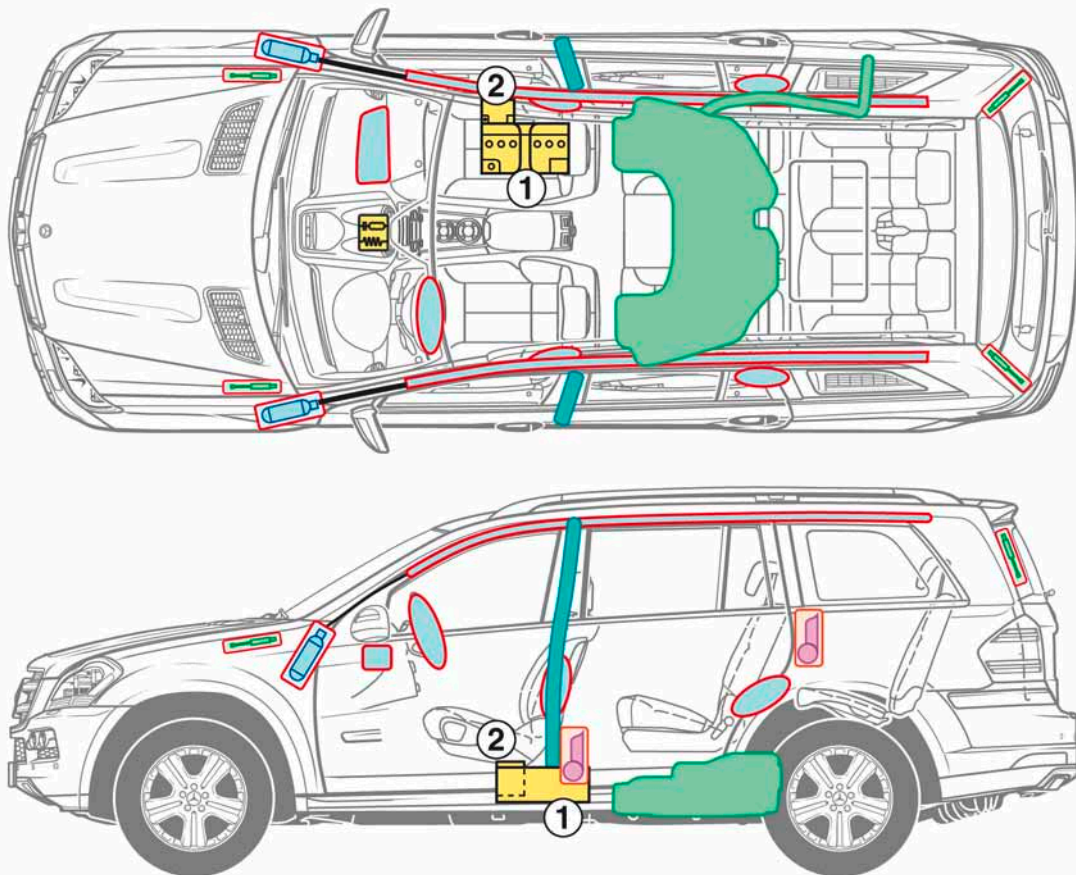

GL-Class
Cross-country
vehicle
Model 164

as of 2006

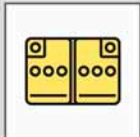
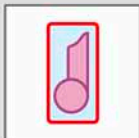
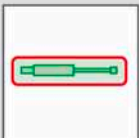

- 1 Main battery
- 2 Additional battery

Legend

	Airbag		Structural reinforcements		Control unit
	Gas generator		Rollover protection		Battery
	Seat belt tensioner		Gas filled spring device		Fuel tank





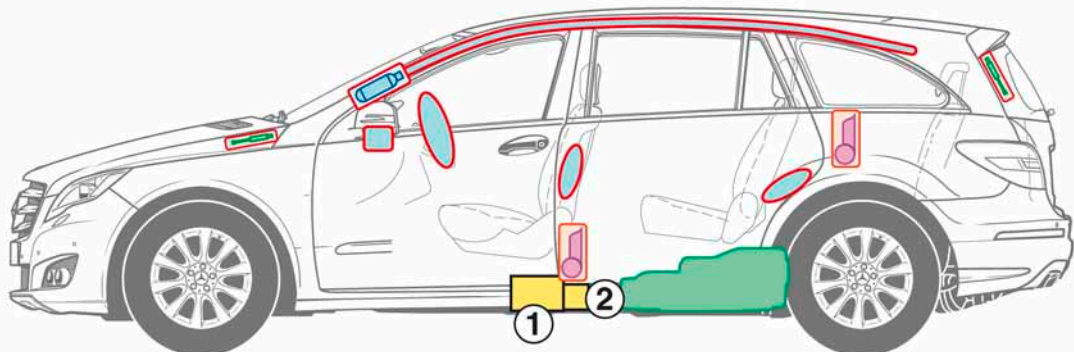
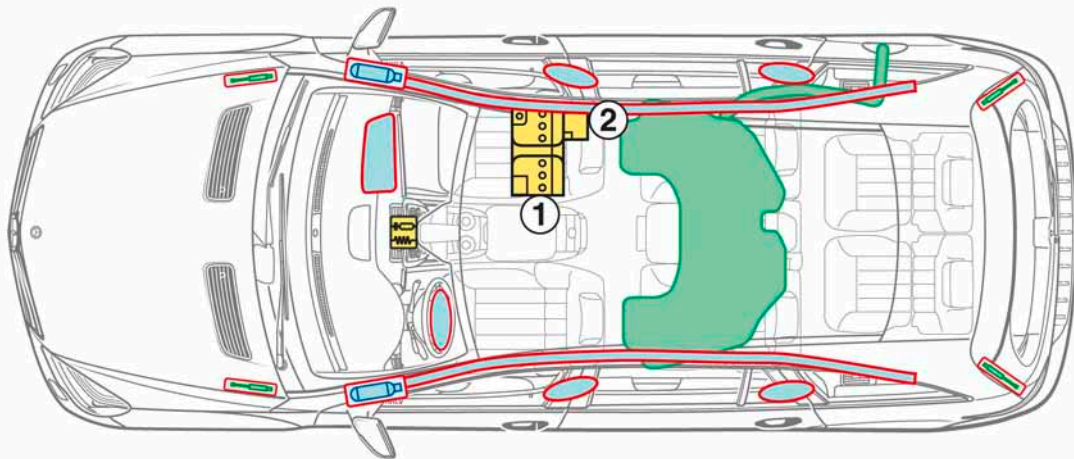

**R-Class
Van
Model 251**

as of 2005

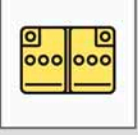
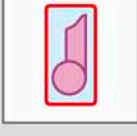
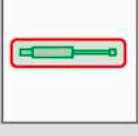

- 1 Main battery
- 2 Additional battery

Legend







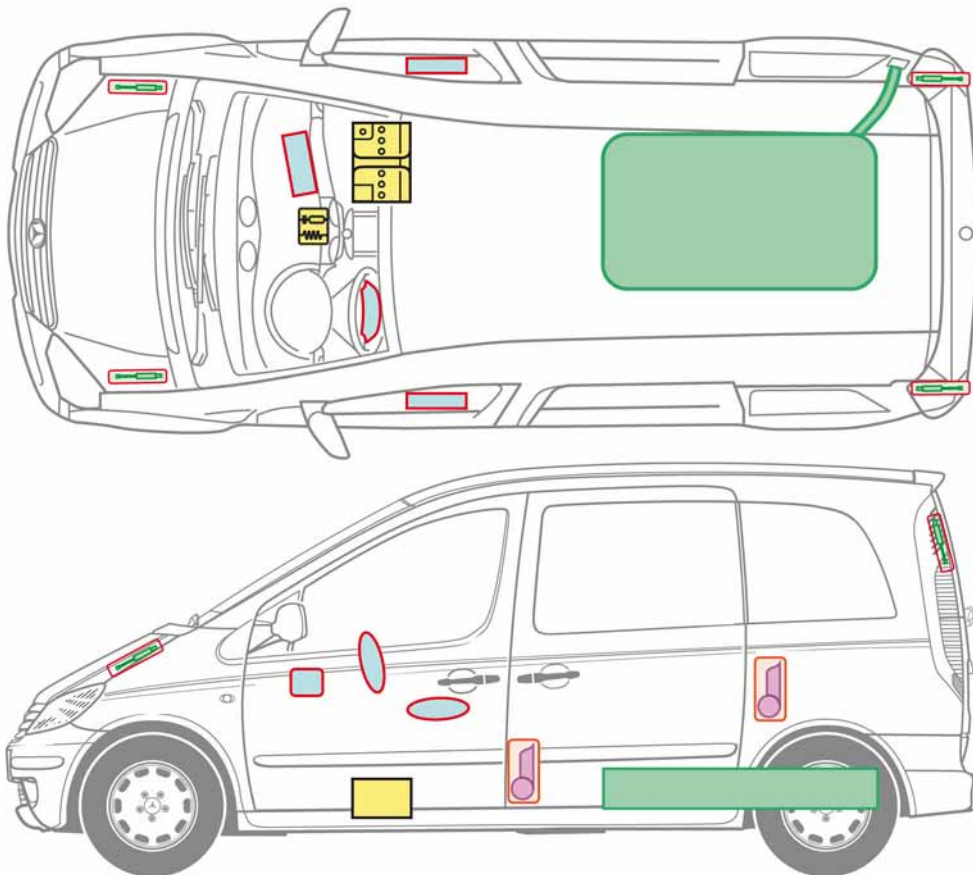

	Airbag		Structural reinforcements		Control unit
	Gas generator		Rollover protection		Battery
	Seat belt tensioner		Gas filled spring device		Fuel tank

**Vaneo
Model 414**

2002-2005



Legend





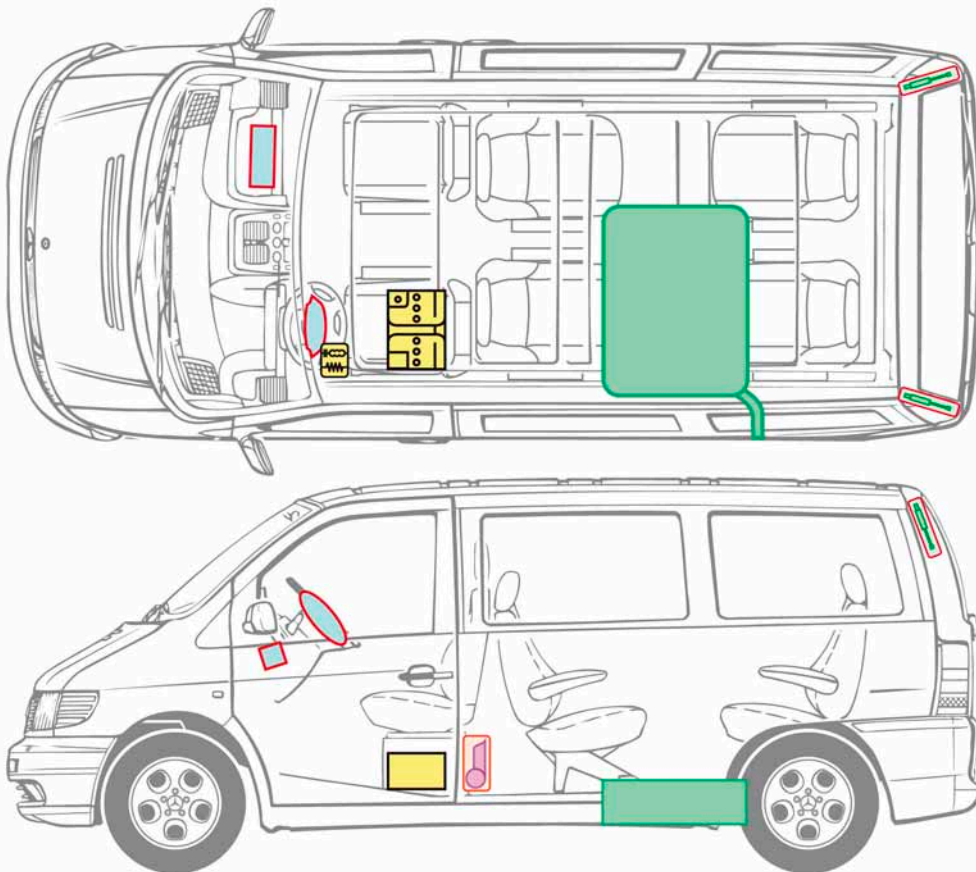

	Airbag		Structural reinforcements		Control unit
	Gas generator		Rollover protection		Battery
	Seat belt tensioner		Gas filled spring device		Fuel tank

**V-Class
Vito
Model 638**

1996-2003

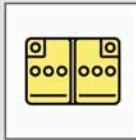
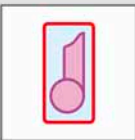
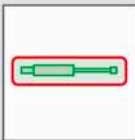

Legend





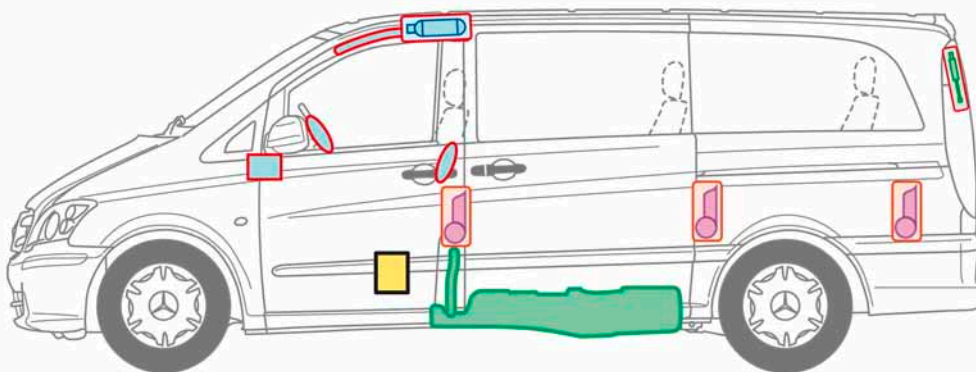
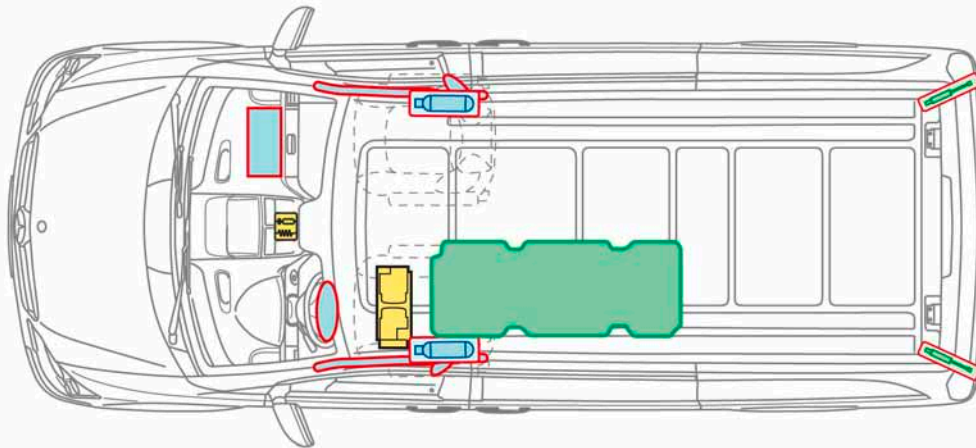

	Airbag		Structural reinforcements		Control unit
	Gas generator		Rollover protection		Battery
	Seat belt tensioner		Gas filled spring device		Fuel tank

**Viano/Vito
Van
Model 639**

as of 2003

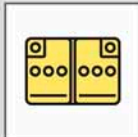
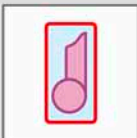
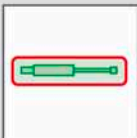

Legend





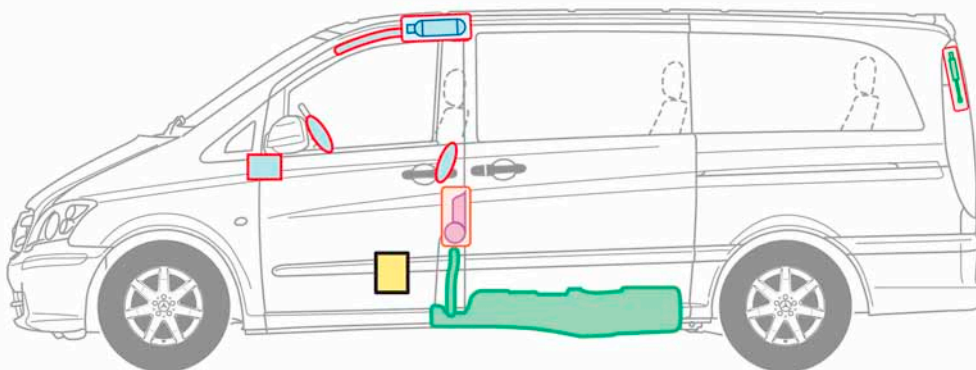
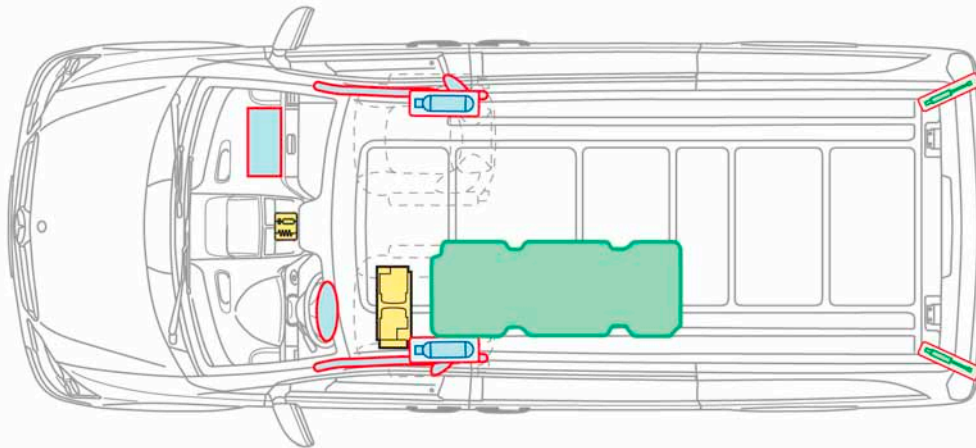

	Airbag		Structural reinforcements		Control unit
	Gas generator		Rollover protection		Battery
	Seat belt tensioner		Gas filled spring device		Fuel tank

Viano
FUN
Model 639

as of 2003

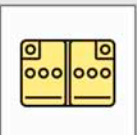
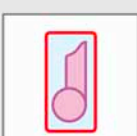
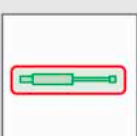

Legend

	Airbag		Structural reinforcements		Control unit
	Gas generator		Rollover protection		Battery
	Seat belt tensioner		Gas filled spring device		Fuel tank

Viano
MARCO POLO
Westfalia
Model 639



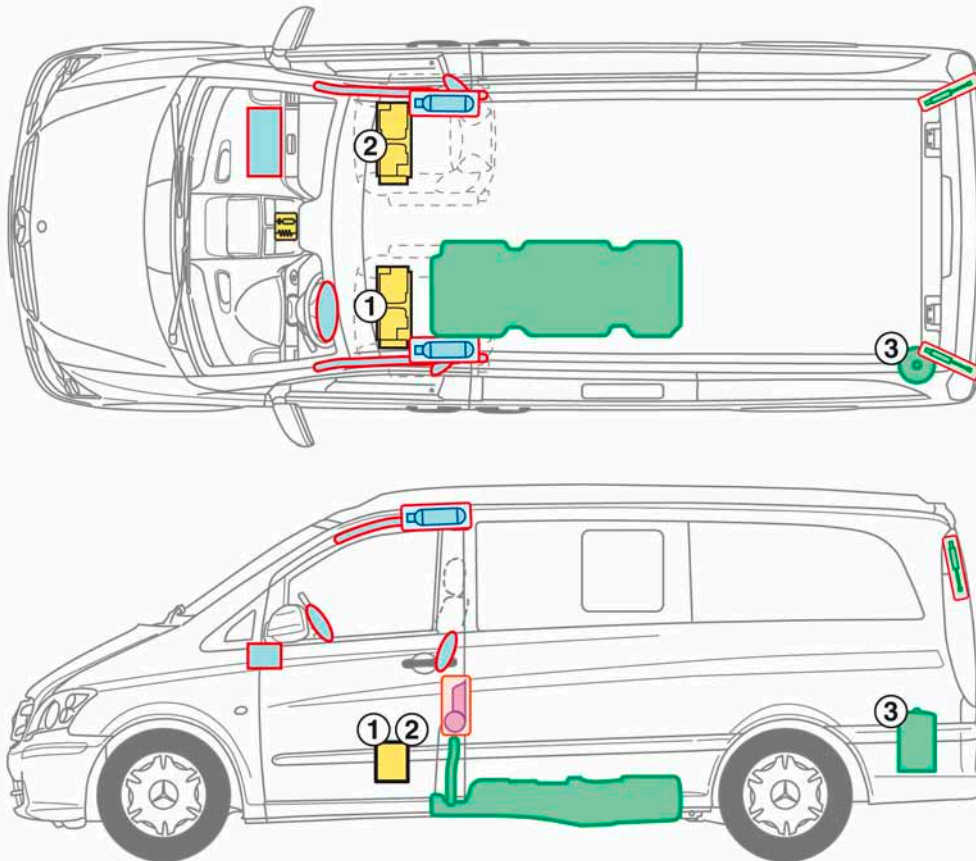



as of 2003



1 Main battery
2 Additional battery

3 Gas cylinder (Camping Gaz, 2,8 kg)

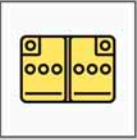
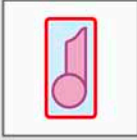
Legend

	Airbag		Structural reinforcements		Control unit
	Gas generator		Rollover protection		Battery
	Seat belt tensioner		Gas filled spring device		Fuel tank



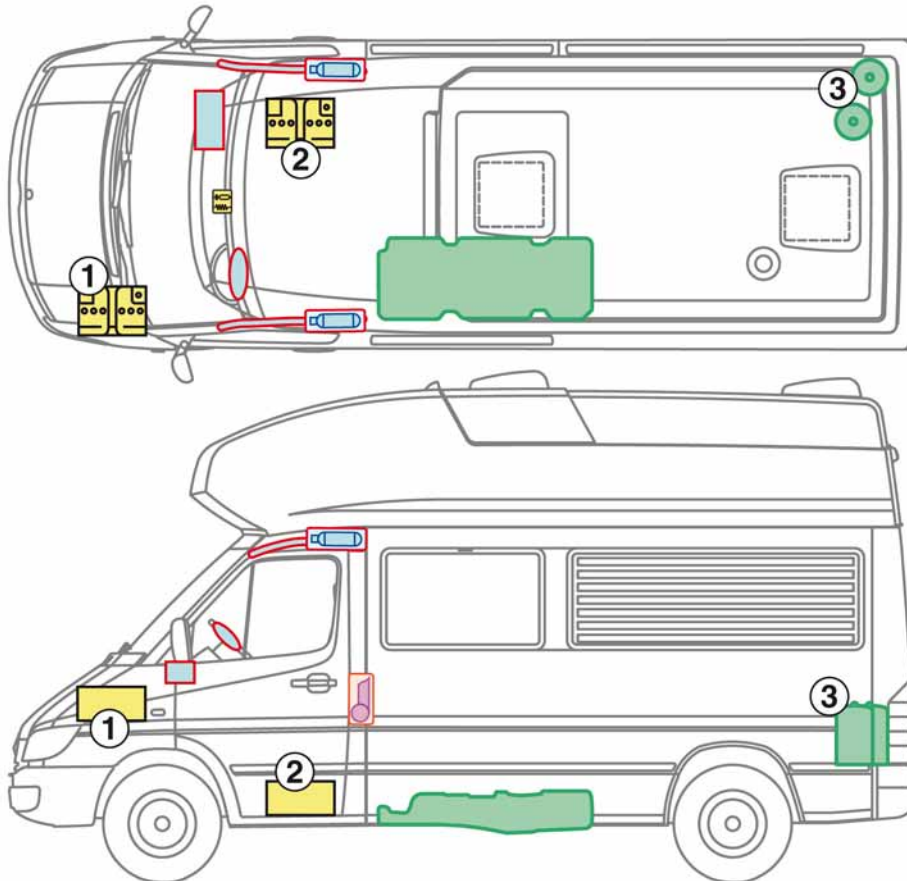



Sprinter
JAMES COOK
Westfalia
Model
901-905
1995-2006



1 Starter battery
 2 Additional battery

3 Gas cylinder (Camping Gaz, 2x5 kg)

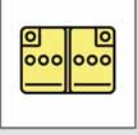
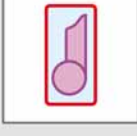
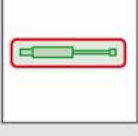
Legend

	Airbag		Structural reinforcements		Control unit
	Gas generator		Rollover protection		Battery
	Seat belt tensioner		Gas filled spring device		Fuel tank

Sprinter
JAMES COOK
Westfalia
Model 906

as of 2006

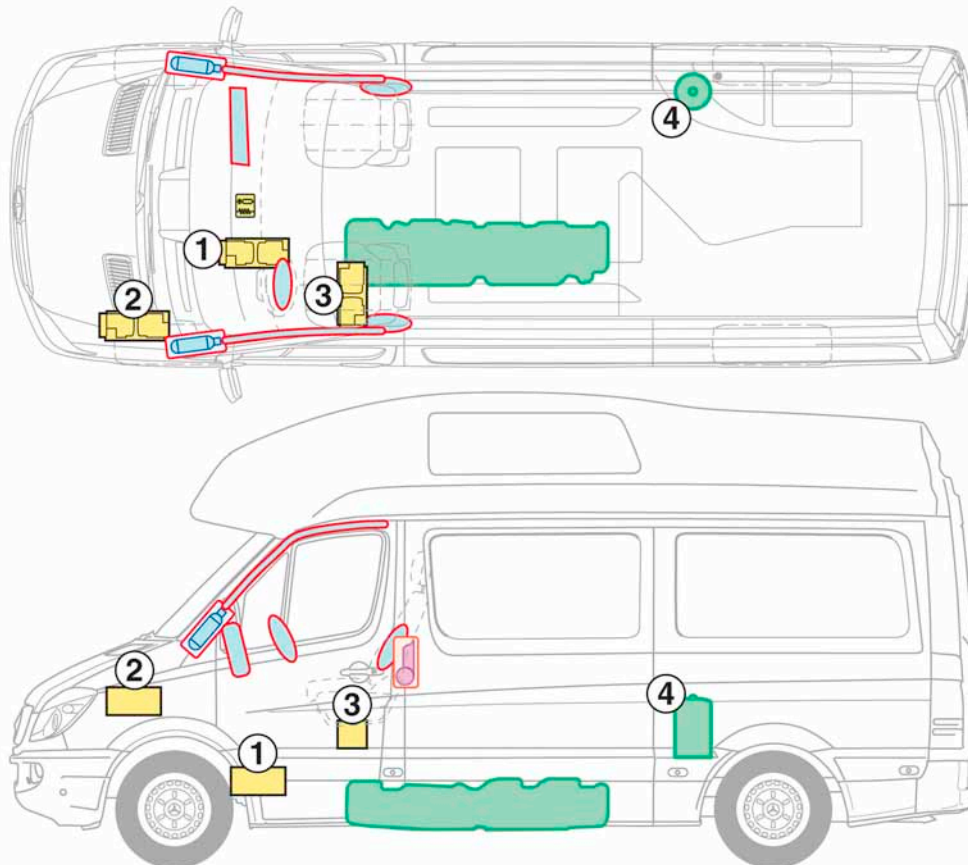









1 Starter battery

2 Additional battery (LHD)

3 Additional battery (RHD)

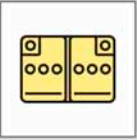
3 Gas cylinder (Camping Gaz, 2,75 kg)

Legend

	Airbag		Structural reinforcements		Control unit
	Gas generator		Rollover protection		Battery
	Seat belt tensioner		Gas filled spring device		Fuel tank

SLS
AMG
Model 197

as of 2010

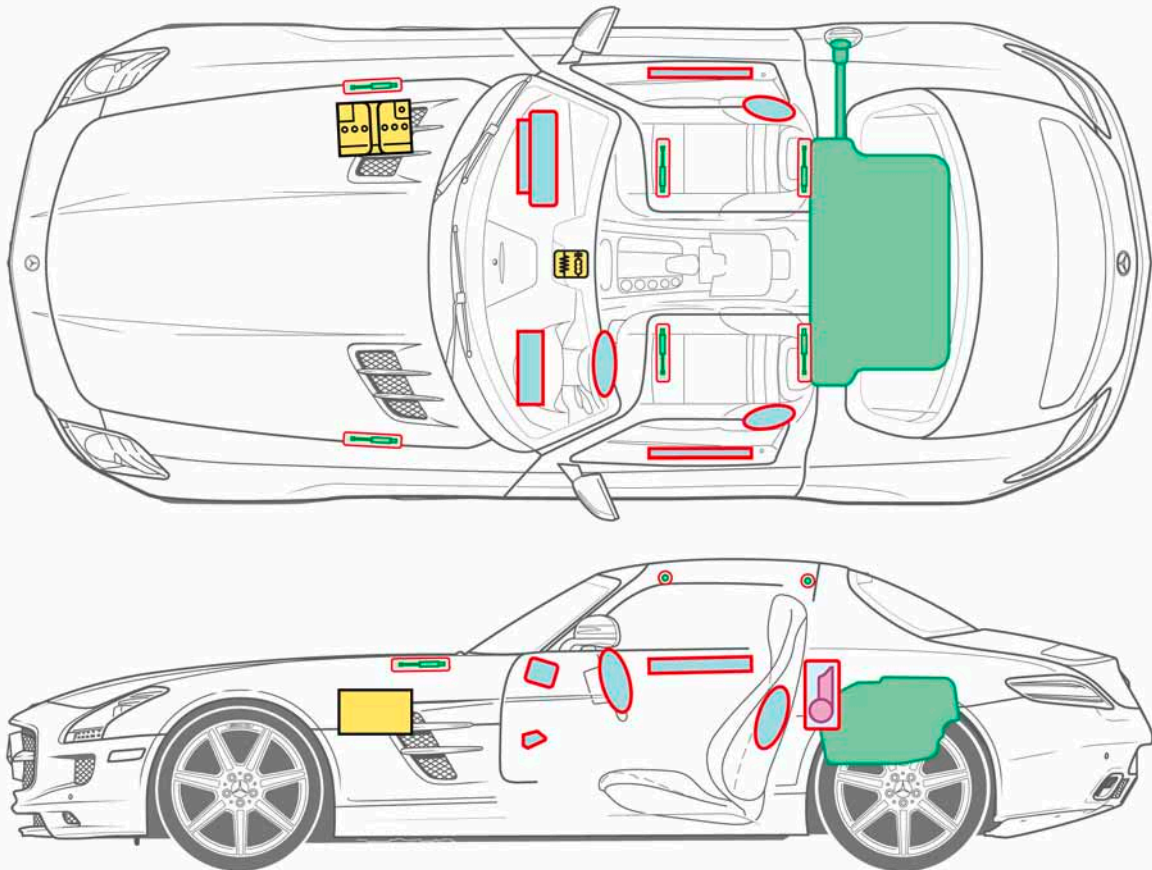

Legend







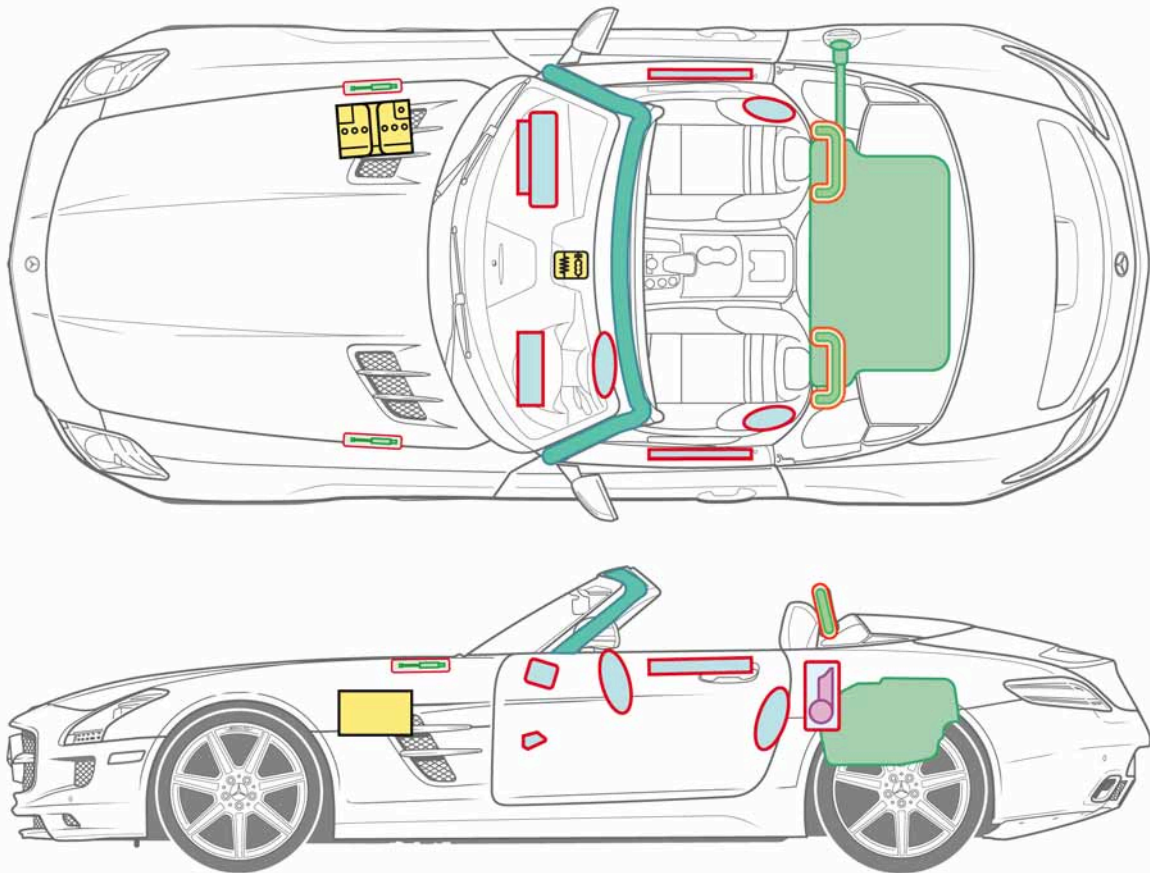

	Airbag		Structural reinforcements		Control unit
	Gas generator		Rollover protection		Battery
	Seat belt tensioner		Gas filled spring device		Fuel tank

SLS
AMG
Roadster
Model 197

as of 2011

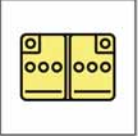

Legend

	Airbag		Structural reinforcements		Control unit
	Gas generator		Rollover protection		Battery
	Seat belt tensioner		Gas filled spring device		Fuel tank



**Maybach
Sedan
Model 240**

as of 2002

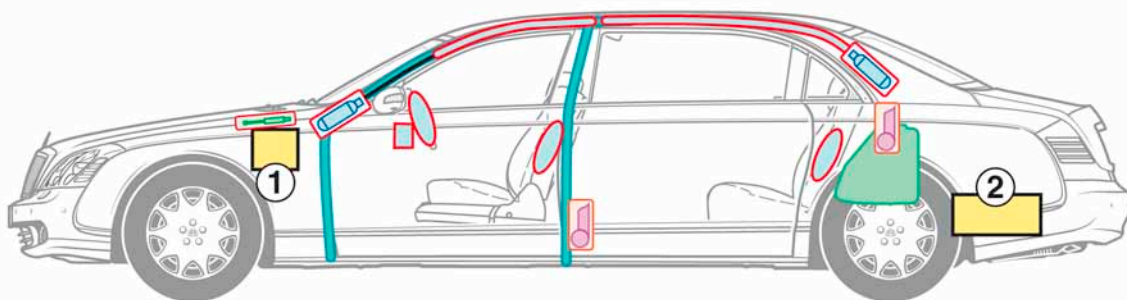
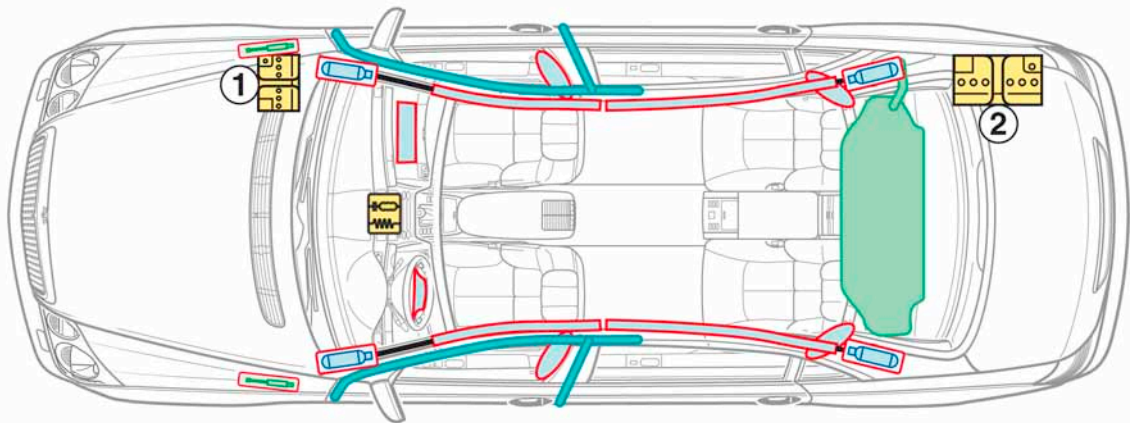

1 Starter battery (engine compartment)

2 Power supply battery (trunk)

Legend

	Airbag		Structural reinforcements		Control unit
	Gas generator		Rollover protection		Battery
	Seat belt tensioner		Gas filled spring device		Fuel tank

smart
fortwo
coupé
Model 450

1998–2007

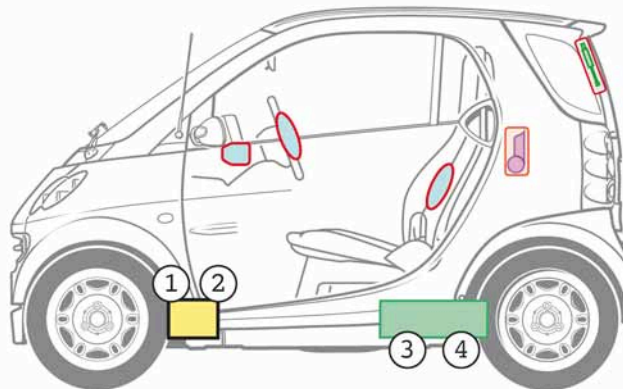
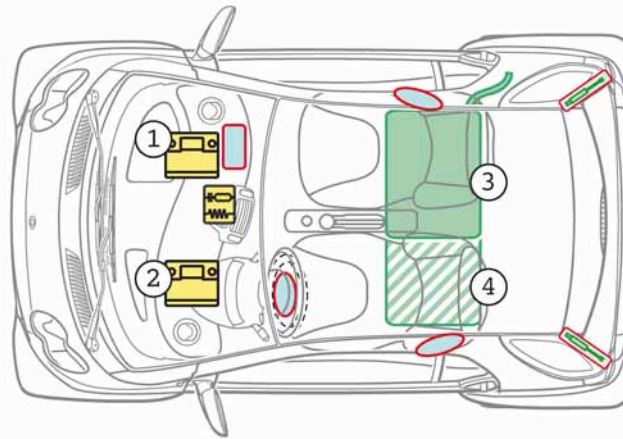

1 LHD vehicle
2 RHD vehicle

3 Fuel tank, vehicle with diesel engine
4 Fuel tank, vehicle with gasoline engine

Legend

	Airbag		Structural reinforcement		Control unit
	Gas generator		Rollover protection		Battery
	Seat belt tensioner		Gas filled spring device		Fuel tank

smart
fortwo
Cabriolet
Model 450

1998–2007

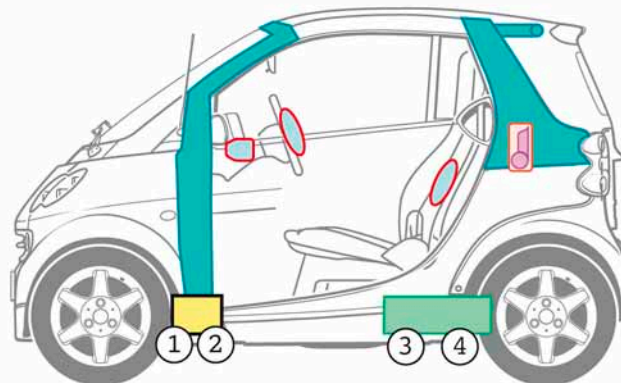
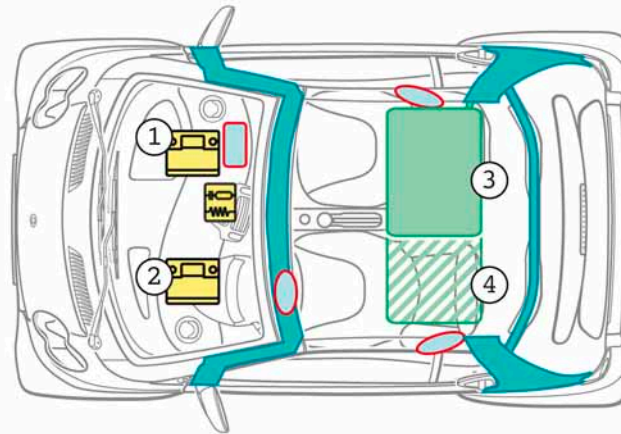

1 LHD vehicle
2 RHD vehicle

3 Fuel tank, vehicle with diesel engine
4 Fuel tank, vehicle with gasoline engine

Legend

	Airbag		Structural reinforcement		Control unit
	Gas generator		Rollover protection		Battery
	Seat belt tensioner		Gas filled spring device		Fuel tank

smart
fortwo
coupé
Model 451

as of 2007

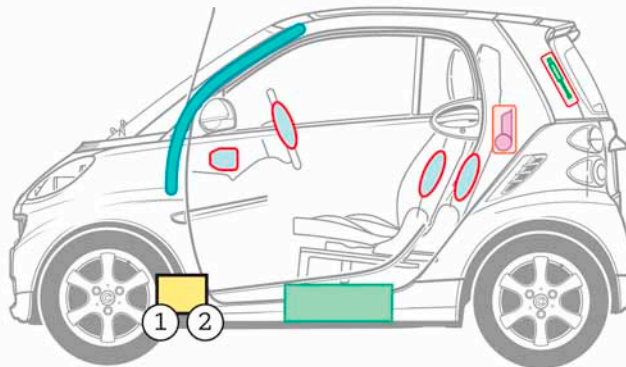
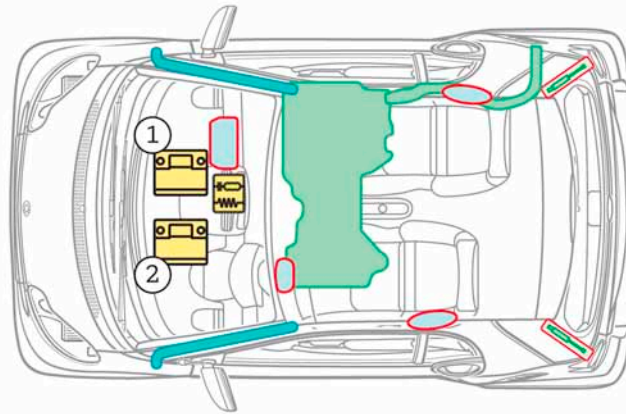

- 1 LHD vehicle
- 2 RHD vehicle

Legend

	Airbag		Structural reinforcement		Control unit
	Gas generator		Rollover protection		Battery
	Seat belt tensioner		Gas filled spring device		Fuel tank

smart
fortwo
Cabriolet
Model 451

as of 2007

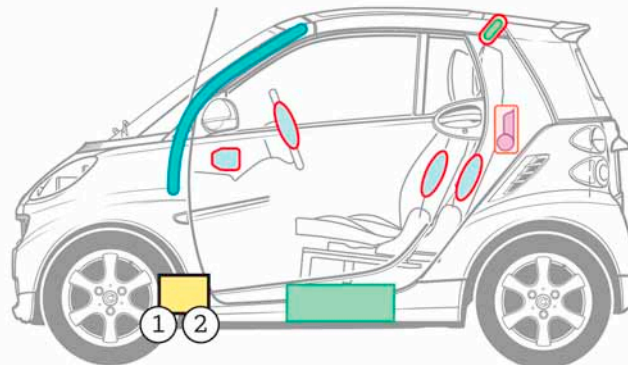
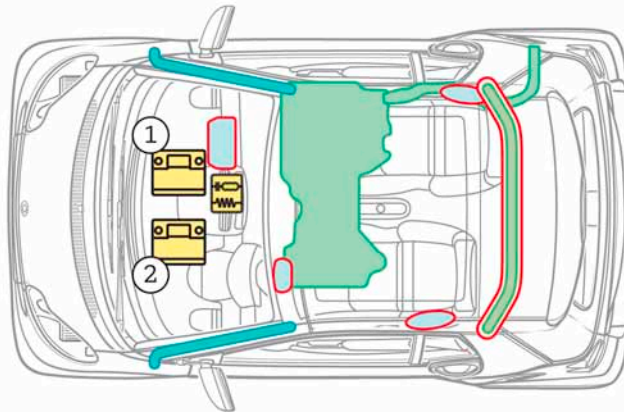

1 LHD vehicle

2 RHD vehicle

Legend

	Airbag		Structural reinforcement		Control unit
	Gas generator		Rollover protection		Battery
	Seat belt tensioner		Gas filled spring device		Fuel tank

smart
fortwo
coupé
electric drive
Model 451
as of 2009

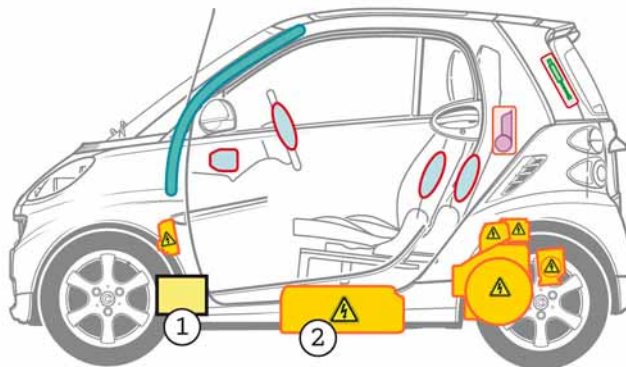
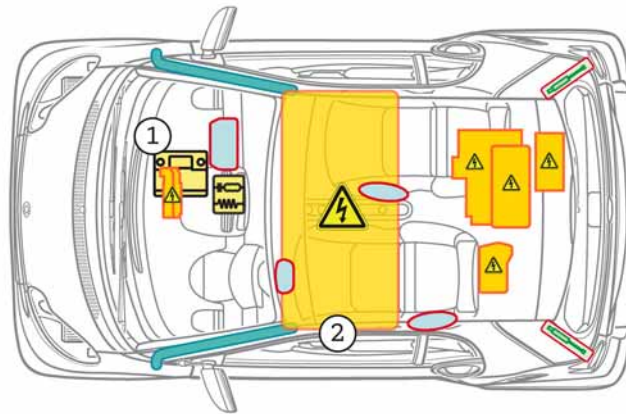

- 1 12 V-battery
- 2 High-voltage battery

Legend

	Airbag		Structural reinforcement		Control unit
	Gas generator		Rollover protection		Battery
	Seat belt tensioner		Gas filled spring device		High-voltage components

smart
fortwo
Cabriolet
electric drive
Model 451
as of 2009

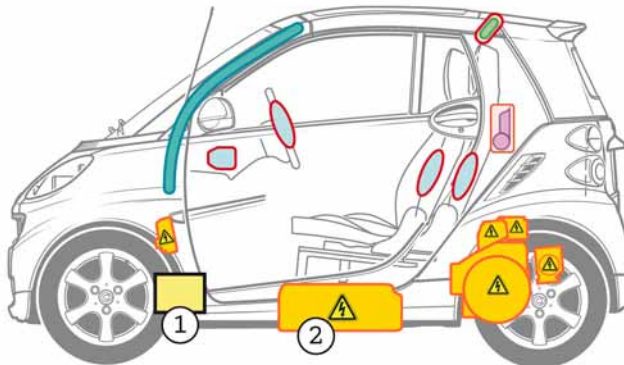
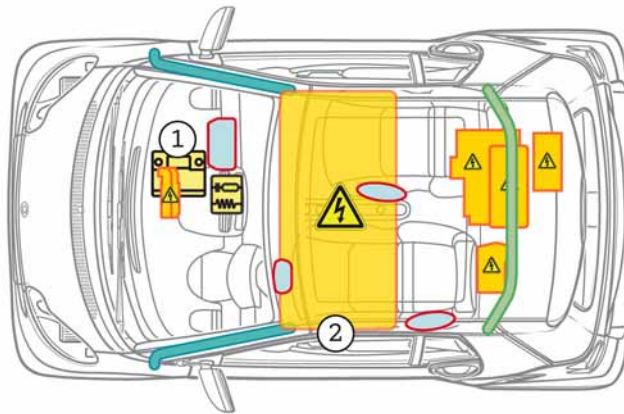

- 1 12 V-battery
- 2 High-voltage battery

Legend

	Airbag		Structural reinforcement		Control unit
	Gas generator		Rollover protection		Battery
	Seat belt tensioner		Gas filled spring device		High-voltage components

smart
roadster
Model 452

2003-2005

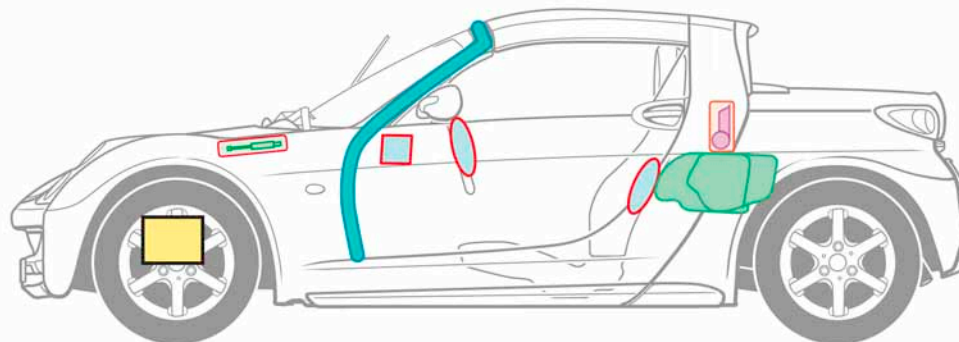
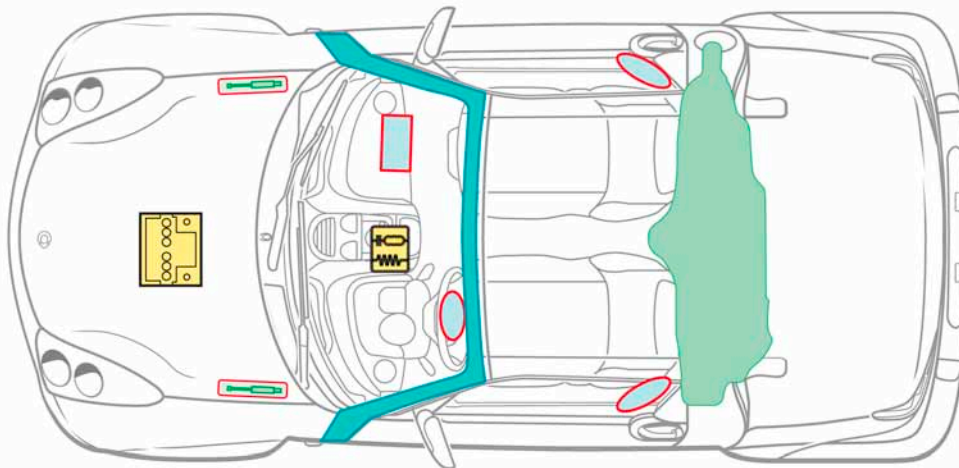

Legend

	Airbag		Structural reinforcement		Control unit
	Gas generator		Rollover protection		Battery
	Seat belt tensioner		Gas filled spring device		Fuel tank

smart
roadster
coupé
Model 452

2003-2005

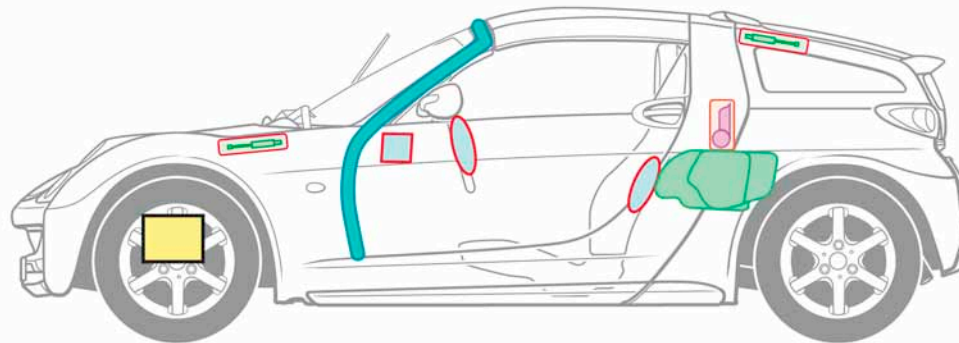
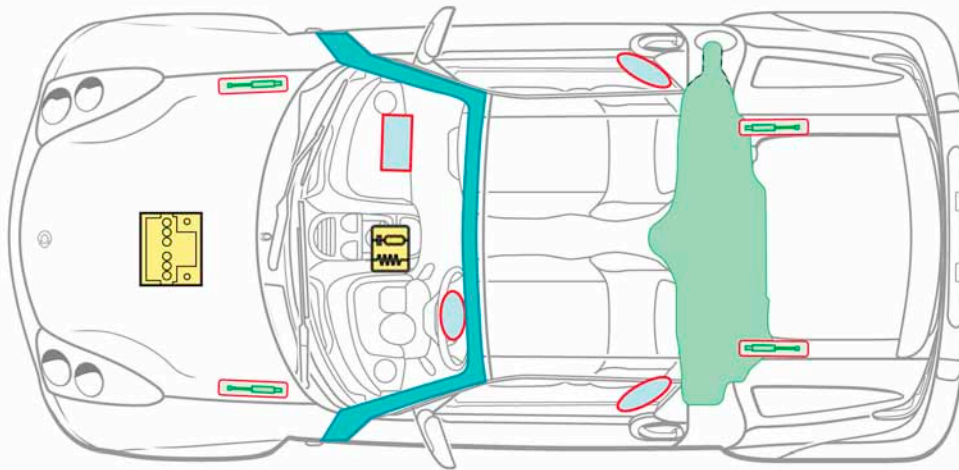

Legend







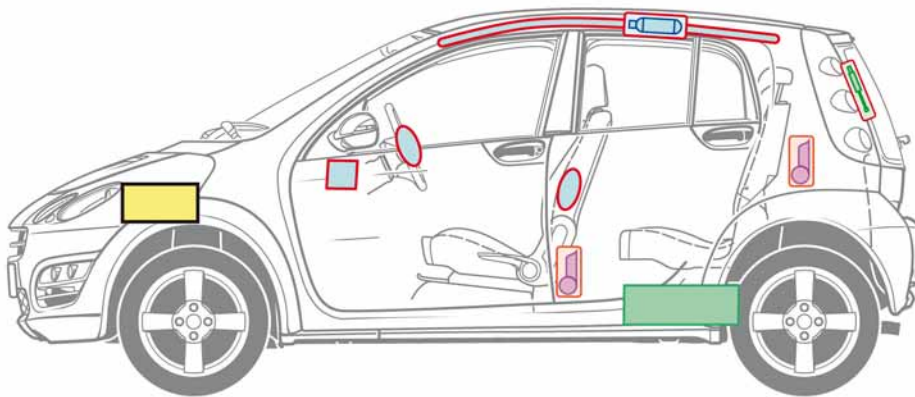
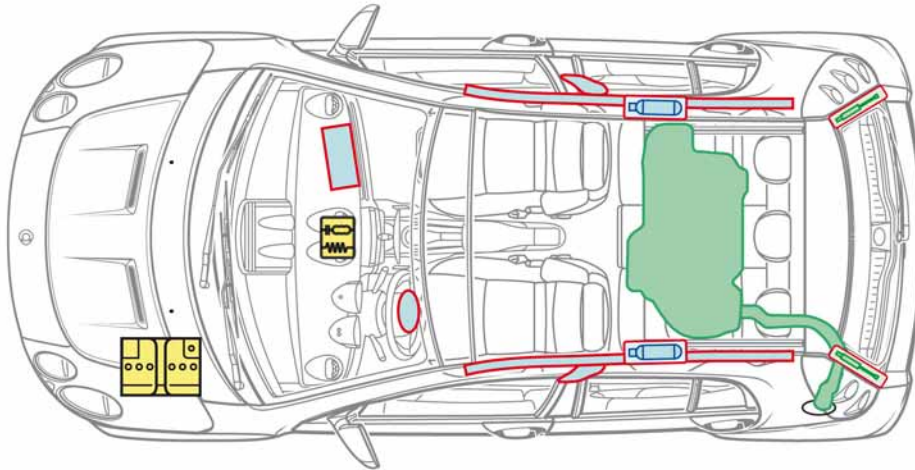

	Airbag		Structural reinforcement		Control unit
	Gas generator		Rollover protection		Battery
	Seat belt tensioner		Gas filled spring device		Fuel tank

smart
forfour
Model 454

2004-2006

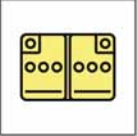

Legend

	Airbag		Structural reinforcement		Control unit
	Gas generator		Rollover protection		Battery
	Seat belt tensioner		Gas filled spring device		Fuel tank

