



Porsche AG, Taycan, all derivatives, Limousine

PORSCHE from Model Year 2019



High voltage!



Secondary emergency disconnection point

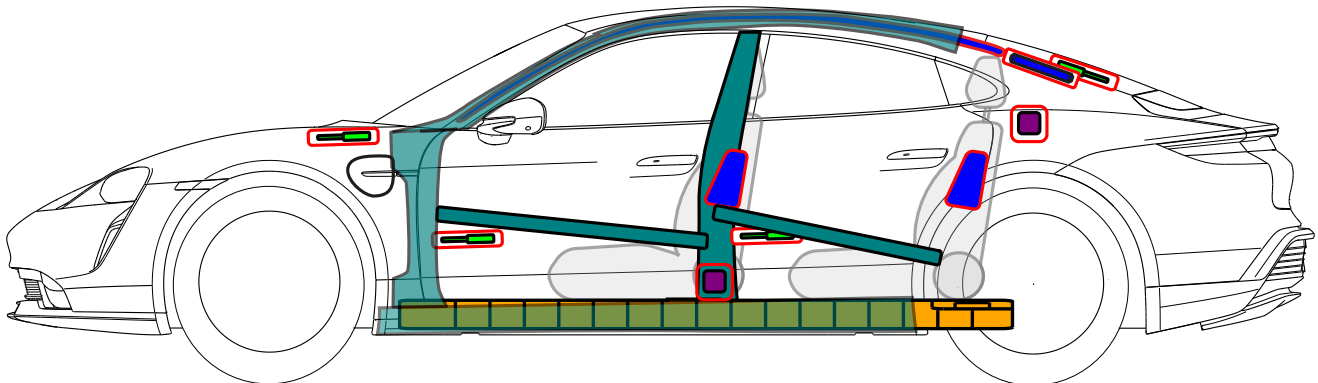
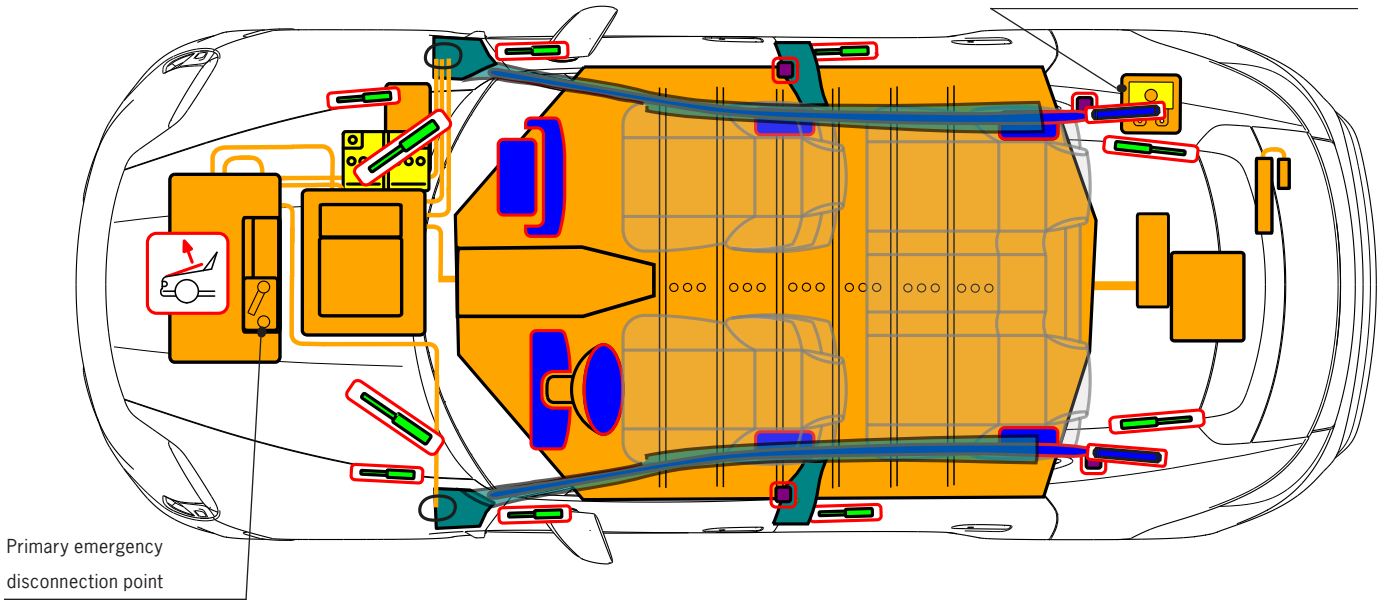

	Airbag		Body reinforcement		SRS-Control unit		High voltage battery
	Gas generator		Gas strut		12-volt battery		High voltage cable/component
	Seat belt pretensioner				Fuse box		High voltage cut-off
	Pedestrian protection system						

1. Identification / recognition

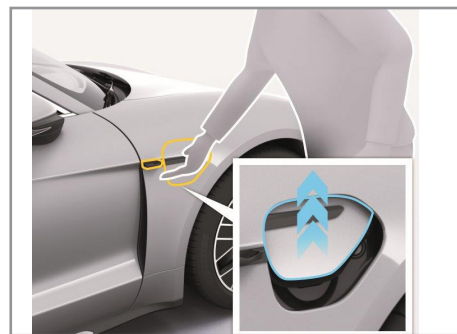

The Porsche Taycan is only available with electric drive.

Taycan

The Porsche Taycan can be identified by its body design, the logo at the rear (can also be deselected) and the electric symbols at the instrument panel.

2. Immobilisation / stabilisation / lifting

Press switch **P**

Parking brake will be automatically activated



3. Disable direct hazards / safety regulations

Switch off ignition

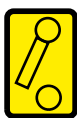

Press **START-STOP** switch without pressing the footbrake.

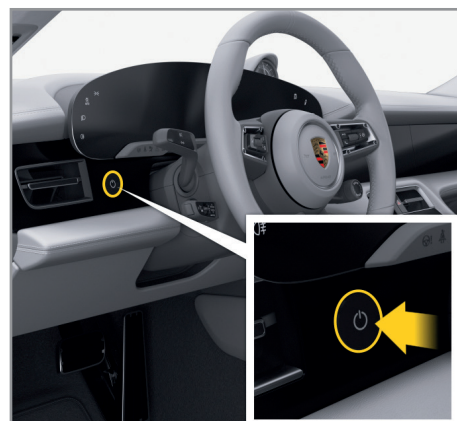
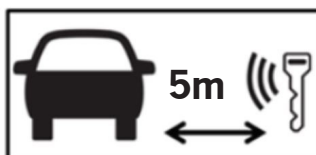

Lack of engine noise does **not** mean that the ignition is off.



A restart is possible until the ignition is switched off.

Deactivation of high voltage system



The high voltage system is automatically switched off in case of a crash with air-bag(s) deployment.



For all other cases, deactivate the high voltage system as follows:

Deactivation of high voltage system



Option 1 - Primary emergency disconnection point:

Remove the cover.

1. Unlock **A**
2. and unplug **a** the service plug (marked with the flag **B**).

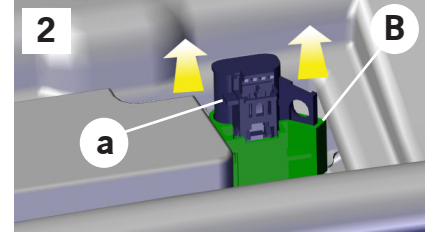
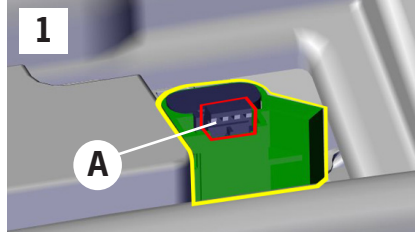
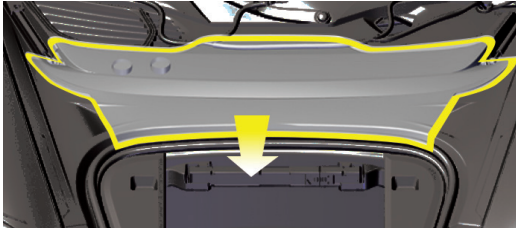
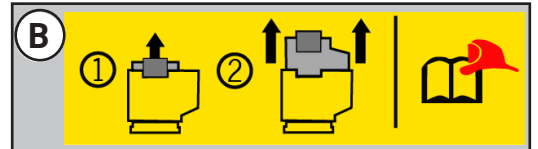

Option 2 - Secondary emergency disconnection point:

1. Remove the side cover in the right-hand side of the boot.
2. Remove the retaining frame (**K**) from the fuse block.
3. Unplug fuse number **1** (marked with the flag **A**).

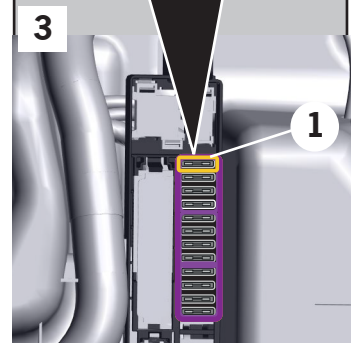
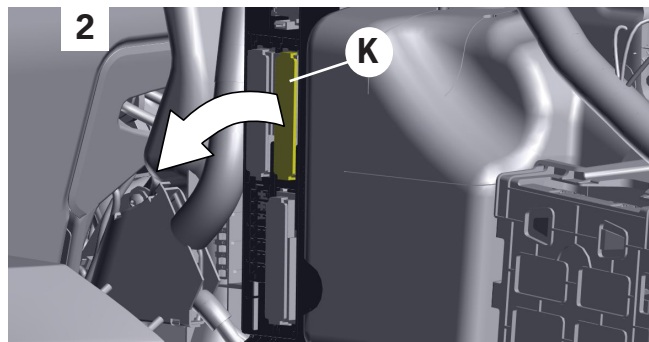
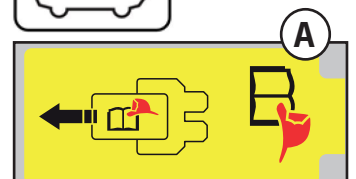

To ensure that there is no remaining voltage in the high voltage system wait approx. 20 seconds after switching it off.



The passive safety systems, such as airbags and seat belt pre-tensioners, are still supplied with voltage from the on-board 12-volt battery.

Disconnect 12 V battery

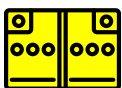

Option 1 - Remove cable 12-V in the front:

1. Remove the cover of the 12-volt battery on the rear right-hand side of the luggage compartment.
2. Disconnect the negative cable of the 12-volt battery and secure it to prevent accidental contact.



The passive safety systems (airbags and seat belt pre-tensioners) are deactivated.

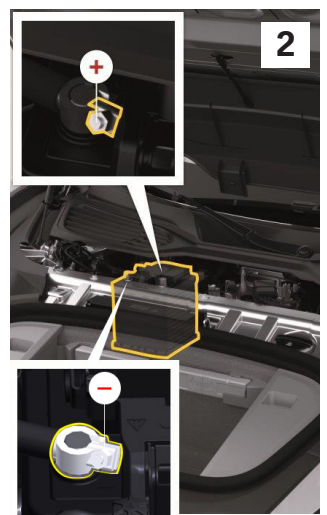

4. Access to the occupants

For the extrication of the occupants the zones of the bodywork consisting of high-strength steels and the components of the restraint systems (especially pyrotechnic elements) should be taken into account as indicated in page 1.

 Additional deformation of the sills and the underbody during the rescue (e.g. support with hydraulic equipment) must be avoided.

5. Stored energy / liquids / gases / solids

LI ION



 High voltage cable have orange coloured isolation.

 NEVER cut, breach or touch high voltage components or cabling. This could result in serious injuries or death.

6. In case of fire

In case of vehicle burn use large amounts of water (H₂O).



 Warning: battery re-ignition



7. In case of submersion

There is no risk of voltage being present on the vehicle body.

After recovering the vehicle:

1. drain the water out of the vehicle
2. and initiate the deactivation of the high voltage system (see chapter 3).

8. Towing / transportation / storage

Transport the vehicle only with both axes on a tow truck or car transporter.



Store at safe distance from other vehicles



Warning: battery re-ignition



9. Important additional information

Additional information about accident assistance and recovery of vehicles with high voltage systems can be found at <https://www.vda.de/en/services/Publications/rescue-and-towing-of-vehicles-with-high-voltage-systems.html>