

Emergency Response Guide

Information on rescue from vehicles that
were in accidents made by the Audi brand

Version dated: 11/2021



Legal notice:

This guide was created only for first and second responders who have specific training in the area of technical assistance following road accidents, and are therefore able to carry out the activities described in this guide.

Specifications and optional equipment for Audi vehicles and the range of vehicles made by Audi AG are subject to ongoing changes.

Audi therefore explicitly reserves the right to make changes or modifications to this guide at any time.

The information factors in the state of knowledge at the date of creation.

Please note:

The information in this guide is not intended for end customers, nor is it intended for workshops and dealerships.

End customers can find information about the functions of their vehicles and important safety information on vehicle and occupant safety in the vehicle wallet of the respective Audi AG vehicle.

Workshops and authorized dealers can obtain repair information from the usual sources known to them.

© Copyright, Audi AG, Ingolstadt, 2021

Content

Preface	05	Disconnect batteries in mild hybrid vehicles (MHEV, 48 volts)	28
0 Rescue sheet/sheets	06	4 Access to the occupants	29
Area of application	08	General notes on use	30
1 Identification/recognition	12	Body reinforcements	32
Distinguishing features of Audi models	13	Glazing	35
Classification of the types of electric drive at Audi	14	Mechanisms for height and forward/back adjustment of Driver seat and steering wheel	36
Distinguishing features of high-voltage vehicles	15	Electrical convenience equipment	36
2 Immobilization/stabilization/lifting	18	5 Stored energy/liquids/gases/solids	37
Prevent the vehicle from rolling away	19	Energy storage device for vehicle drive	38
Switch off the ignition	20	Vehicles with a high-voltage system	39
Lift the vehicle	21	High-voltage safety concept	40
3 Disable direct hazards/safety regulations	22	Warning labels for high-voltage components	42
12 V electrical system	23	The high-voltage battery	43
Cut-off points for deactivating the high-voltage system	24	Differences in installation concepts for high-voltage batteries	45
Disconnect high voltage device in the engine/motor compartment ...	25	Battery information, general first aid measures and aspects relevant to environmental protection	48
Disconnect high voltage device in the passenger compartment.	25	A/C system	48
Disconnect high voltage device in the vehicle rear.	26	Compressed air tank	48
High-voltage service disconnect for the Q5 hybrid, A6 hybrid, A8 hybrid	26	Flammable materials	48
Disconnect from the charging station (emergency release)	27		

6	In case of fire	49
	Vehicle fire	50
	Fires in high-voltage vehicles	51
7	In case of submersion	53
	Vehicle under water	54
	High-voltage vehicle under water	54
8	Towing/transportation/storage	55
	Recovery of vehicles that have been in accidents	56
	Recovery of high-voltage vehicles	56
9	Important additional information	59
	Airbag	60
	Airbag gas generators	65
	Seat belt pretensioners	65
	Automatic Rollover Support System	69
	Re-active hood	70
10	Explanation of pictograms used	71

Preface

Driver, vehicle and surroundings: the interaction between these specific factors is decisive for road safety.

The vehicle is expected to perform the following functions, among others, when an accident occurs:

- Provide a rigid passenger cell to ensure a survival space to the greatest extent possible.
- Reduce the impact energy by means of intelligent structural concepts and elements.
- Protect the occupants effectively by means of an optimized restraint system – consisting of airbags and seat belts with seat belt pretensioners and safety belt load limiters.
- Provide safety equipment to minimize the hazards presented by operating equipment or drive components.

International tests have shown that Audi vehicles are among the safest vehicles of all. However, accidents and the resulting injuries cannot be ruled out. The existence of a short, fast and effective response procedure therefore

remains essential. This guide was created in accordance with ISO 17840 and aims to support first and second responders in performing their tasks by giving them the information they require regarding the technology used in Audi vehicles.

Technical innovations, such as new materials or drive technologies, mean the approach to recovering occupants from vehicles that have been involved in accidents needs to be changed.

The processes and procedures are usually governed by official regulations or guidelines issued by legislators or the emergency organizations themselves in the different countries around the world. When information about the approach is provided in this Emergency Response Guide, it should therefore only be considered to be a suggestion.

The information is specifically intended for the training and further training of first and second responders. Corresponding rescue sheets are available for Audi vehicles for those working at the scene of the accident.

The latest respective version can be found at www.audi.com/rescue.

0. Rescue sheet/ sheets

0. Rescue sheet/sheets

Audi provides rescue sheets for all models and vehicle versions.

A model overview (www.audi.com/rescue) lists all models made by the Audi brand. The individual rescue sheets can be downloaded directly from the model overview.

The figure shown here shows the first page of the rescue sheet for the Audi e-tron, which was created in accordance with ISO 17840-1:2015, as an example.

The latest, complete rescue sheet and all other sheets issued by Audi are available from www.audi.com/rescue.

	<p>The rescue sheets for all vehicles that entered the market from 2020 on were created in accordance with ISO 17840. For vehicles made before this, the rescue sheets are structured using the manufacturer's layout.</p>
---	--



Audi e-tron

SUV incl. Sportback, as of 2020

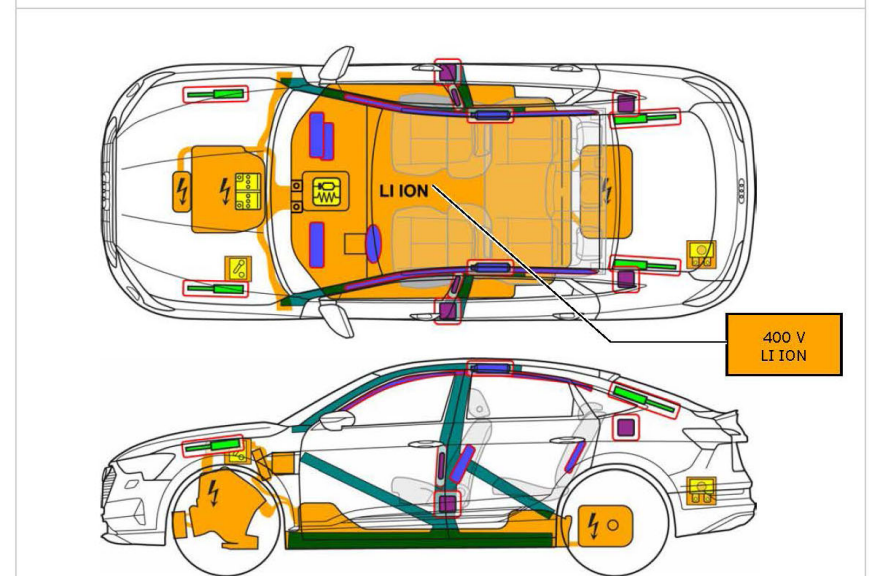

Note: The illustration shows the maximum possible range of equipment.

	Airbag		Stored gas inflator		Seat belt pretensioner		SRS control unit		Pedestrian protection active system
	Automatic roll-over protection system		Gas strut / preloaded spring		High-strength zones		Special attention		
	Battery, low-voltage		Ultra-capacitor, low-voltage		Fuel tank		Gas tank		Safety valve
	Battery, high-voltage		Power cable, high-voltage		Separator, high-voltage		Fuse box, disabling high-voltage system		Ultra-capacitor, high-voltage
	High-voltage separator to low voltage		Fuse box, disabling high-voltage to low voltage		High-voltage component				

Additional information

Document number
rds au 513 001 en

Version
06/2021

Page
1 of 4

Area of application

This Emergency Response Guide is valid for all vehicles made by the Audi brand.

The model range is highly diverse, and extends from compact cars to sports cars, while also including vehicles with gasoline and diesel engines, and natural gas, gasoline-hybrid drives and fully electric drivetrains.

Not all of the models are applicable for the North American Region.

Current Audi model range

A3



A3 Sportback



A3 Sportback e-tron
(High Voltage)



A3 Sedan



S3 Sportback



S3 Sedan



RS 3 Sportback



RS 3 Sedan

Current Audi model range

A4



A4 Sedan



A4 Avant



A4 allroad quattro



S4 Sedan



S4 Avant



RS 4 Avant

A5



A5 Coupé



A5 Sportback



A5 Convertible



S5 Coupé



S5 Sportback

0. Rescue sheet/sheets

Current Audi model range



S5 Convertible



RS 5 Coupé



RS 5 Sportback

A6



A6 Sedan



A6 Sedan TFSI e (High Voltage)



A6 Avant



A6 Avant TFSI e (High Voltage)



A6 allroad quattro



S6 Sedan



S6 Avant



RS 6 Avant

A7



A7 Sportback



A7 Sportback TFSI e (High Voltage)

Current Audi model range



S7 Sportback



RS 7 Sportback

A8



A8



A8 L



A8 TFSI e (High Voltage)



A8 L TFSI e (High Voltage)



S8

Q2



Q2



SQ2

Q3



Q3



Q3 TFSI e (High Voltage)

0. Rescue sheet/sheets

Current Audi model range



Q3 Sportback



Q3 Sportback TFSI e
(High Voltage)



RS Q3



RS Q3 Sportback

Q4
e-tron



Q4 e-tron (High Voltage)



Q4 Sportback e-tron
(High Voltage)

Q5



Q5



Q5 TFSI e (High Voltage)



Q5 Sportback



Q5 Sportback TFSI e
(High Voltage)



SQ5

Current Audi model range



SQ5 Sportback

Q7



Q7



Q7 TFSI e (High Voltage)



SQ7

Q8



Q8



Q8 TFSI e (High Voltage)







SQ8







RS Q8



Current Audi model range

e-tron	 Audi e-tron (High Voltage)	 Audi e-tron Sportback (High Voltage)
	 Audi e-tron S (High Voltage)	 Audi e-tron S Sportback (High Voltage)

e-tron GT	 e-tron GT quattro (High Voltage)	 RS e-tron GT (High Voltage)
----------------------	---	---

TT	 TT Coupe	 TT Roadster
	 TTS Coupe	 TTS Roadster

Current Audi model range

R8	 TT RS Roadster	 R8 Coupé V10 performance	 R8 Spyder V10 performance
-----------	---	---	--

1. Identification/ recognition

Distinguishing features of Audi models

Along with the Audi logo with the four rings, the individual models can also be identified by the respective body shape, body size, and the individual vehicle design. In addition, the model name and the technology lettering on the rear of the vehicle can also help with identification. The lettering is not there, however, if its removal was requested upon purchase, or it was subsequently removed.

Audi logo



Audi logo in the radiator grille



Audi logo on the rear lid

Model name



Model name on the rear of the vehicle

Classification of the types of electric drive at Audi

After an accident, high-voltage vehicles present different hazards to first and second responders than vehicles with a conventional drive. This is why it is important to be able to recognize these vehicles on the scene.

Audi offers a number of different versions of electric drive that differ with regard to the primary energy source, the voltage, the type of drive motor and the electric range.

A distinction is made between the following versions without an external charging socket:

- Mild hybrid electric vehicle (MHEV)
- Full hybrid electric vehicle (HEV)

and the following versions with an external charging socket:

- Plug-in hybrid electric vehicle (PHEV)
- Battery electric vehicle (BEV)









The different electric drive concepts are shown in the table.

Mild hybrid vehicles (MHEV) with vehicle electrical system voltages up to 48 V DC are not high-voltage vehicles.



The exterior of these vehicles is no different to conventional

Audi vehicles of the same respective model.

All other versions listed are high-voltage vehicles.

	Mild-Hybrid	Full-Hybrid	Plug-In Hybrid	Battery Electric Vehicle
Voltage	12-48 V	200-300 V	300-450	300-950 V
Electric motor	10-15 kW	20-50 kW	60-120 kW	> 150 kW
Electric driving range		approx. 3 km	approx. 50 km	> 200 km
Source of energy	 	 	  	 
Examples	A3 A4 A5 A6 A7 A8 Q5 Q8	Q5 hybrid A6 hybrid A8 hybrid	A3 e-tron Q7 e-tron Q5 TFSI e A6 TFSI e A7 TFSI e A8 TFSI e	e-tron e-tron sportback e-tron GT

Key for energy sources

Symbol	Designation
	Conventional fuels such as gasoline and diesel fuel
	Battery operation
	Battery operation with charging option using a socket

Distinguishing features of high-voltage vehicles

1. Features on the outside of the vehicle

- Model name “e-tron” or technology lettering “TFSI e”
The current high-voltage vehicles from Audi can be identified by the model lettering “e-tron” (fully electric vehicles) or by the technology lettering “TFSI e” (plug-in hybrid). Earlier full-hybrid models from Audi can be identified by the “hybrid” model lettering.
- External charging socket for the high-voltage battery:
The charging socket flap with the charging socket is installed either on the fender or on the rear side panel. The charging socket flap is integrated into the radiator grille behind the Audi rings in the A3 e-tron (2014 to 2020).

Model name and technology lettering on high-voltage vehicles



Lettering e-tron on the rear lid on the current-model fully electric vehicles



Lettering “TFSI e” on the rear lid on the current-model plug-in hybrid vehicles

Model name and technology lettering on high-voltage vehicles



Lettering “hybrid” on the rear lid on the earlier full-hybrid models



The lettering for model names and drive technology differ according to model. They may, however, have been removed by the vehicle owners.

Charging socket for high-voltage vehicles



Charging socket “e-tron” on the fender (both sides possible)



Charging socket A6 “TFSI e” on the rear side panel

1. Identification/recognition

Charging socket for high-voltage vehicles



Charging socket A3 e-tron (2014 to 2020) in the radiator grille

Different charging sockets



Charging socket type 1 AC (e.g. in NAR, South Korea, Japan)



Charging socket CHAdeMo DC (e.g. in Japan)

Different charging sockets



Charging socket CCS2 DC and AC (e.g. in the EU)



Charging socket type 2 AV (e.g. in the EU)



Charging socket CCS1 DC and AC (e.g. in NAR, South Korea)

1. Identification/recognition

2. Features in the engine/motor compartment

- Orange high-voltage cables
- All high-voltage cables and high-voltage connectors in visible areas are fitted with orange insulation. The cables may, however, be concealed by covers.
- Internationally standardized warning labels for high-voltage technology

Features in the engine/motor compartment



Orange high-voltage cables in the engine/motor compartment



Warning labels

3. Features in the vehicle interior

- Electric vehicle-specific displays in the instrument cluster, such as charging displays and power displays (“READY” for drive-ready)
- “EV Mode” button in the center console
- Model lettering on the instrument panel

Features in the vehicle interior



Digital instrument cluster that can be freely programmed, with power display and charge level display



“EV Mode” button in the center console



“e-tron” lettering on the instrument panel

2. Immobilization/stabilization/ lifting

Prevent the vehicle from rolling away

Audi models are equipped with either a manual transmission or an automatic transmission.

To prevent the vehicle from rolling away or unintentionally driving away, as a first step, the gearshift lever in vehicles with a manual transmission must be shifted to the “Neutral” position, and the selector lever must be shifted to the “P” position in vehicles with automatic transmission. In automatic vehicles without a selector lever, the “P” button must be pressed.



Vehicle with an automatic transmission with a selector lever: Place the selector lever in the “P” position

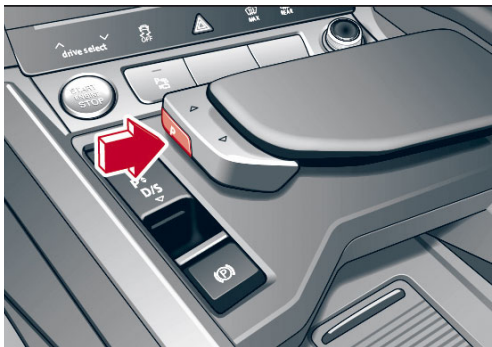

Vehicle with an automatic transmission without a selector lever: press the “P” button



Vehicle with an automatic transmission without a selector lever: Press the “P” button

In the second step, the mechanical or electric parking brake must be located and engaged. The switch for the electric parking brake is usually installed next to, or behind, the selector/shift gate and is engaged by “pulling”.

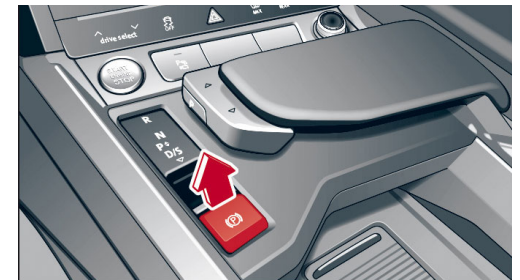

Switch for the electric parking brake

Switch off the ignition

The ignition in vehicles with an ignition lock is switched off by turning the ignition key toward the occupants; "Position 0" as shown in the diagram.

No conventional ignition lock is installed in vehicles with Keyless Access with push-button start. Drivers only need to have the vehicle key on their person (keyless entry and keyless go).

The "START ENGINE STOP" button is used to switch the ignition on or off and to start or stop the motor.

The "START ENGINE STOP" button is installed in the center console or in the instrument panel.

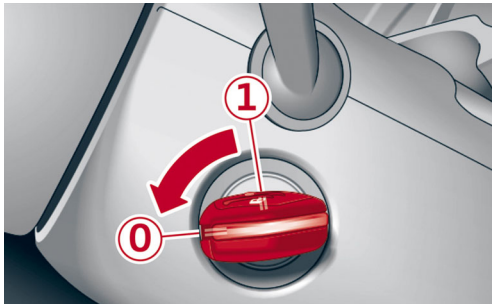

Vehicle with ignition lock



"START ENGINE STOP" button



The electric motor in vehicles with a high-voltage drive is silent. The display in the instrument cluster (power display) provides feedback about whether the electric drivetrain is drive-ready "READY" or switched "OFF".



„READY“
Drive switched on
Vehicle ready





„OFF“
Drive switched off





If the "START ENGINE STOP" button is pressed and the brake pedal is pressed at the same time, the vehicles may switch to drive-ready mode! Observe the information on the rescue sheets!

Lifting the vehicle

Vehicle-specific lifting points and prohibited points are indicated on the rescue sheets.

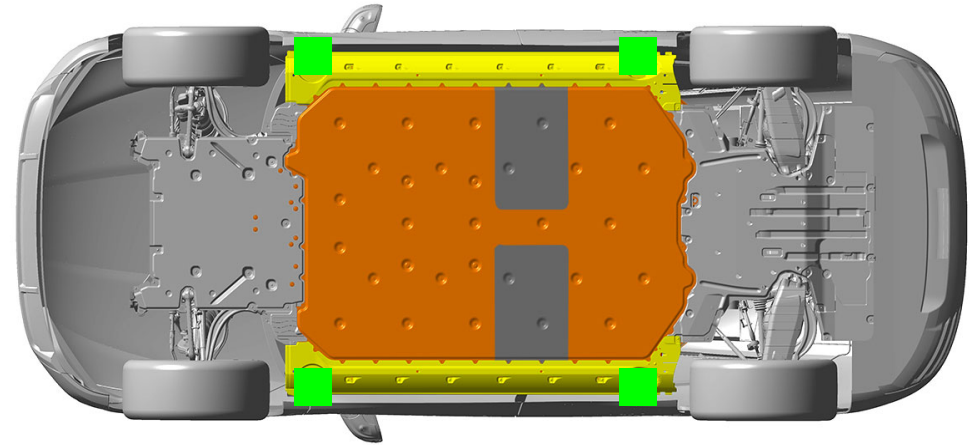
	When vehicles have been damaged in an accident, the first and second responders will decide on the scene which points may be used to lift the vehicle.
	If possible, lift the vehicle at the lifting points indicated.



 Suitable lifting points

 High-voltage battery

Illustration of suitable lifting points using the Audi e-tron GT as an example.

3. Disable direct hazards/safety regulations

12 V electrical system

As the range of vehicle equipment available becomes more and more extensive, the number of power consumers also increases, making several energy storage devices necessary.

This also has an impact on rescue operations, as additional points need to be observed when deactivating the vehicle electrical system (switching off the ignition, disconnecting the batteries).

Switch off the ignition

The procedure for “switching off the ignition” is explained in chapter 2, “Immobilization/stabilization/lifting”.

Disconnect 12 V vehicle battery

Deactivating the vehicle electrical system reduces the risk of fire due to short circuits, but also the risk of any subsequent activation of airbags, seat belt pretensioners or the Automatic Rollover Support System.



When the vehicle electrical system is deactivated, it must also be ensured that the power supply to any trailers that are coupled is disconnected and any solar elements in the sunroof are covered.

	<p>When the 12 V vehicle battery has been disconnected, all functions of the vehicle electrical system stop operating (applies in particular for the emergency flashers and electric seat adjustment). Observe the additional information in chapter 4 “Access to the occupants” and chapter 9 “Important additional information”.</p>
---	--

Depending on the type of vehicle and equipment, there may be one or several 12 V vehicle batteries installed.

The position of the 12 V vehicle battery/batteries can be found on the rescue sheet.

If the battery is to be fully disconnected, disconnect the ground/negative battery terminal, as otherwise there is a risk of short circuit. The negative terminal must be protected from repeat contact (isolate, tie down, bend away etc.). Once the battery has been disconnected, check whether the vehicle is, in fact, de-energized. If the emergency flashers or the interior lighting goes out, this can provide an indication.

	<p>The position(s) of the 12 V vehicle battery/batteries is/are shown on the rescue sheets.</p>
	<p>It is also necessary to disconnect the battery when the batteries feature a pyrotechnic isolator in order to fully de-energize the vehicle.</p>

In vehicles with 48 V DC or high-voltage technology, in addition to disconnecting the 12 V vehicle battery, the 48 V DC battery or the high-voltage system must be deactivated as well in order to fully de-energize the vehicle. See the information on the next few pages.

For high-voltage vehicles: Disconnect devices for deactivating the high-voltage system

These disconnect high voltage devices, also called emergency cut-off points, provide first and second responders with an easy access option to deactivate the high-voltage system without risk.





In the event of accidents in which airbags are deployed, the high-voltage system is automatically deactivated. It takes around 20 seconds for the high-voltage system to be de-energized.

	<p>The high-voltage system and the vehicle electrical system only need to be isolated if the vehicle can no longer be driven using its own power.</p>
---	---

As a rule, there are at least two disconnect high voltage devices – one at the vehicle front end and one in the interior or in the luggage compartment. At least one of them should be accessible regardless of the accident scenario.

These disconnect high voltage devices, which are marked by yellow flags, only conduct the 12 V vehicle electrical system voltage and can therefore be disconnected by the first and second responders without risk when they follow the procedure described on the flags.

	<p>Operating an disconnect high voltage device only deactivates the high-voltage system. Safety systems such as airbags or seat belt pretensioners will still be supplied by the 12 V vehicle electrical system.</p>
---	--

	<p>The position of the disconnect high voltage devices and the procedure for deactivating the vehicle are specified on the rescue sheets issued by Audi.</p>
	<p>The electric motor in vehicles with a high-voltage drive is silent. This is why it is particularly important to deactivate the vehicle when dealing with high-voltage vehicles. Observe the information on the respective rescue sheets.</p>
	<p>After operating the disconnect high voltage device, it takes around 20 seconds until the high-voltage system is de-energized. When airbags are deployed, the high-voltage system is automatically de-energized. No additional waiting time is necessary for the first and second responders. One of the disconnect high voltage devices that is accessible can also be opened to verify this.</p>
	<p>Even after the high-voltage system has been deactivated, there is still voltage inside the high-voltage battery. This is why the high-voltage battery may therefore neither be damaged, nor be opened, when performing rescue measures. If the high-voltage battery has been damaged by the accident, make sure to avoid contact with the high-voltage battery or any fluids or vapors that escape from the high-voltage battery!</p>

3. Disable direct hazards/safety regulations

Disconnect high voltage device in the engine/ motor compartment

A feature called the low-voltage service disconnect in the engine/motor compartment is used as an disconnect high voltage device for the high-voltage system in plug-in vehicles (PHEV) and electric vehicles (BEV). The connector has a green connector housing and a tab to release it. A yellow label on the connector cable clearly indicates that the connector is an disconnect high voltage device.

The connector is marked with the “High-voltage disconnect high voltage device” symbol on the rescue sheet.



Disconnect high voltage device in the engine/motor compartment of the Audi Q4 e-tron

Procedure for deactivation of the high-voltage system using the disconnect high voltage device:



Pull out the red tab



Press and hold the red tab and while doing so, pull out the black connector until it locks in place.

Disconnect high voltage device in the passenger compartment

An additional disconnect high voltage device is located on the fuse panel (in the interior near the instrument panel or in the luggage compartment), and the respective fuse is marked by a yellow flag. Disconnection and therefore deactivation of the high-voltage system is carried out by pulling the marked fuse out of its slot.

This also opens the contactors in the high-voltage battery, which disconnects the battery from the remaining high-voltage system, taking 20 seconds until it is de-energized.

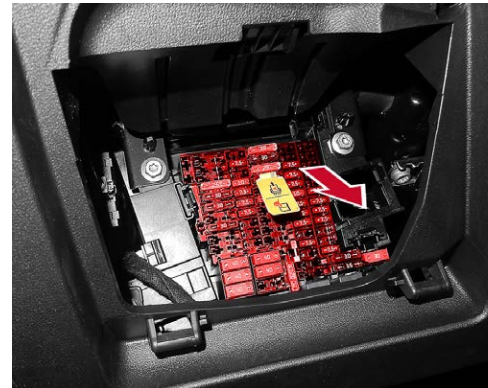

Disconnect high voltage device in passenger compartment, instrument panel on the fuse panel

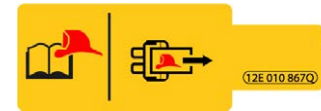

Label for the disconnect high voltage device in the passenger compartment or luggage compartment (fuse on the fuse panel)

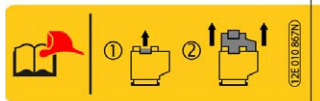

Label for the disconnect high voltage device in the engine/motor compartment

3. Disable direct hazards/safety regulations

Disconnect high voltage device in the vehicle rear

On some models there may be an additional cut-off point in the rear of the vehicle. Identify the cable that is marked by a yellow flag to be cut through.

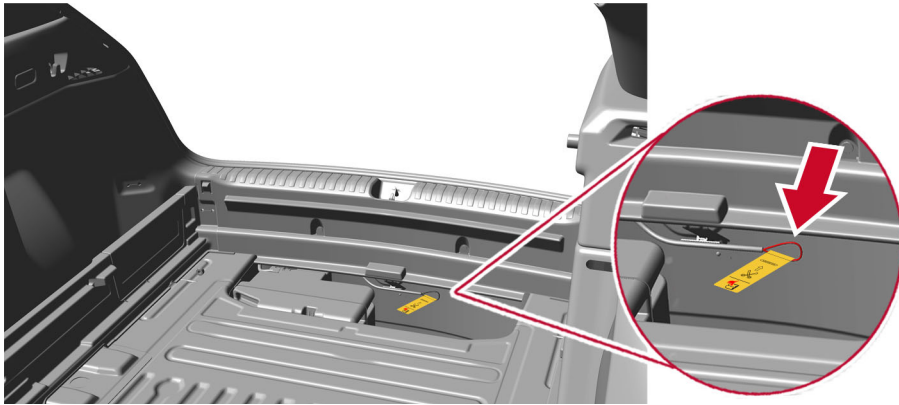

Disconnect high voltage device in the Q4 e-tron luggage compartment under the luggage compartment floor at the rear end. The yellow flag indicates the cut-off point.

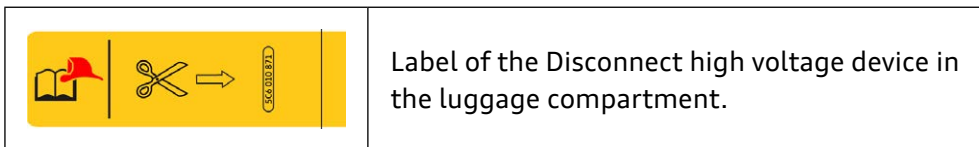

High-voltage service disconnect for a Q5 hybrid, A6 hybrid, A8 hybrid

The hybrid vehicles (HEV) Q5 hybrid (2011–2016), A6 hybrid (2012–2015), and A8 hybrid (2012–2017) feature a different type of high-voltage service disconnect plug.

This high-voltage service disconnect plug is installed in the center of the luggage compartment floor under a flap that must be opened. The orange protective rubber cap below it must be removed. The exact position can be found in the rescue sheets.

Direct operation of this high-voltage service disconnect plug is shown in the figures. The lever is pulled to the rear in a first step, folded up in a second step and removed by pulling it upward.



Pull the lever to the rear





Fold the lever upward and remove the connector by pulling it upward.

Disconnect from the charging station (emergency release)



Because high-voltage vehicles are generally charged while parked, high-voltage charging stations to which a vehicle is connected can be found in public car parks, private carports or public or private garages.

The more high-voltage vehicles there are on the market, the more public and private high-voltage charging stations will be installed. This must be taken into account by first and second responders that are deployed to the scene of an emergency or fire when assessing the situation and defining the measures to be taken.



	Public charging stations for the power supply are, under some circumstances, connected to the public high-voltage grid with a voltage of more than 1,000 V. If this is the case, correspondingly larger safety distances must be maintained when dealing with a fire.
	The necessary procedure for emergency release from the charging station is described on the rescue cards.

Another difference is the type of charging voltage. There are systems that charge with alternating voltage and systems that charge with direct voltage. A system with direct voltage (DC) supplies the battery directly using the charging socket. If alternating voltage (AC) is used to charge the high-voltage battery, the battery charger in the vehicle functions as a voltage converter.

	Observe any existing regional and country-specific action plans for first and second responders for public charging stations!
	The charging sockets and the appearance of public and private charging stations differ depending on the manufacturer and country.

For vehicles with 48 V DC technology: battery disconnection for mild-hybrid vehicles (MHEV)

Today's vehicles have intelligent drive systems and a large number of assistance systems. Depending on the model type and equipment, along with the 12 V vehicle electrical system, an additional 48 V DC vehicle electrical system is installed and operated using a lithium-ion battery.

A number of examples of use are:

- Roll stabilization
- Advanced start/stop mode using a belt-driven start-alternator

These vehicles are in the mild hybrid electric vehicle (MHEV) category. The mild hybrid vehicles with vehicle electrical system voltages of up to 48 V DC are not high-voltage vehicles.



	In the event of accidents involving airbag deployment, the 48 V DC vehicle electrical system is automatically deactivated.
---	--

In all other cases, along with the 12 V lead battery, the 48 V DC lithium-ion battery must be disconnected to deactivate the entire vehicle electrical system.

	The ignition must be switched off before disconnecting the batteries!
---	---

To minimize the risk of an electric arc, the following procedure is recommended:

After locating the batteries (see rescue sheet), the negative terminal of the 12 V lead battery must be disconnected in the first step. Only after this is the lithium-ion battery disconnected in a second step. In this case, disconnecting the communication connector before disconnecting the negative terminal is recommended.

	The exterior of the vehicles with 48 V DC technology does not differ from the 12 V version of the respective model.
	The installation position and the procedure when disconnecting the terminals of the 48 V DC battery is described in the rescue sheets.

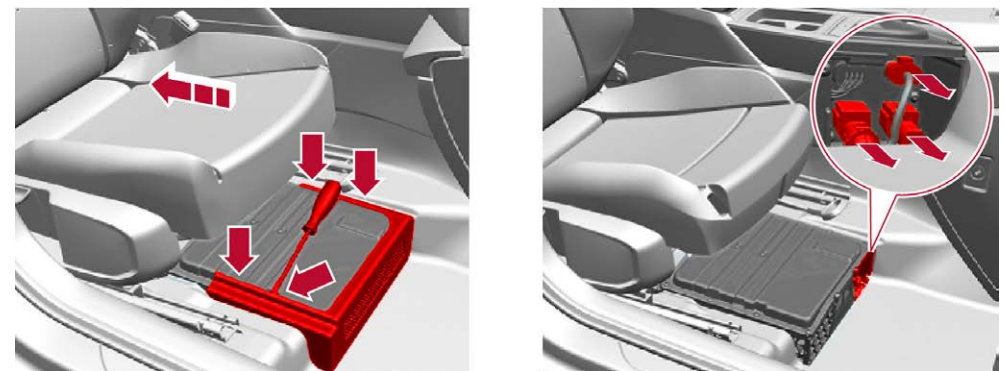

Disconnection of the 48 V DC vehicle electrical system for the Audi A3 Sportback.

4. Access to the occupants

General notes on use

A Stay at arm's length

The deployment range of safety systems that have not deployed should be kept clear. This applies in particular when heavy rescue equipment is used, or cable connections have been cut. Neither bodies nor tools may be within the deployment range of the airbag at this time. When medically appropriate, the patient should be removed from the deployment range. Seat belts that have been fastened should be cut or unfastened due to seat belt pretensioners that have not deployed. If there are any rollover bars that did not deploy, their deployment range should also be kept clear.

I Survey the interior

To determine the status of the safety systems, a survey of the vehicle interior must be carried out when rescue operations begin.

All airbag modules are marked by "AIRBAG" lettering. The label is usually found on the airbag module or close to it.

The side airbags installed in the backrests may also be labeled by a flag that is sewn into the backrest cover. There are often several labels on head curtain airbags in the upper part of the vehicle pillars, or along the roof pillar.

Any seat belt pretensioners installed are not marked. The Automatic Rollover Support System is only used in convertibles, where it is installed behind the rear head restraints. The cover for the Automatic Rollover Support System is marked by the imprint "Do not cover".



The maximum number of airbags, seat belt pretensioners and, if applicable, Automatic Rollover Support Systems that the vehicle can be equipped with can be found in the rescue sheets.



Labels indicating side airbags may be concealed by the seat belt or by protective covers!



The fitting locations of the seat belt pretensioner and the Automatic Rollover Support System can be found in the rescue sheets.

R Warn first responders

All first and second responders at the scene of the accident should be informed about the type and status of the safety systems encountered immediately after completing a survey of the vehicle.

This is the only way to ensure that all necessary safety rules are complied with during the rescue operations.

B Battery management

The majority of Audi vehicles are equipped with electrical ignition systems for the airbags and for the seat belt pretensioners. Electrical activation of the airbags by the control module for safety systems is not possible when the voltage supply has been disconnected. To deactivate the safety systems, the vehicle that was in the accident should therefore be de-energized.

The procedure for switching off the engine/electric motor or drive and for deactivating/disconnecting the batteries is described in chapters 2 and 3.



The position of the batteries can be found in the rescue sheets.

4. Access to the occupants

A Removal of the interior trim

Regardless of the design, gas generators of airbags that did not deploy, and seat belt pretensioners that did not deploy, should not be damaged.

This has special significance during roof removal, especially when cutting the vehicle pillars or cutting the lower area of the B-pillar.

To ensure that the seat belt pretensioners and gas generators are not damaged, the following measures are recommended:

- Removal of the interior trim
Before cutting vehicle pillars, the interior trim in the planned area of the cut should be removed. Any gas generators or seat belt pretensioners installed will then be visible, and a cut can be chosen that avoids damaging them. The layout of gas generators for head curtain airbags in Audi vehicles is mirror-inverted. If the installation location on one side of the vehicle is known, then the gas generator is in the same position on the other side of the vehicle.
- Checking the installation position using the rescue sheets
The rescue sheets should show the installation position of gas generators and seat belt pretensioners, among other items. The use of rescue equipment can be planned in a way that prevents damage to these components.

G Danger at airbag components

Airbags and seat belt pretensioners that deployed and an Automatic Rollover Support System that deployed

If an airbag that deployed is in the way, it can be pushed aside or, if necessary, be cut off. The dust that was released when the airbag deploys and when it is compressed can cause a slight irritation of the mucous membranes and the skin. The vehicle interior should be ventilated when possible. Wearing protective gloves/safety goggles is recommended. Exposed areas of the skin should be washed off with water as a precaution following rescue operations. Because the area around the gas generator can remain hot for quite some time, do not use an airbag module that has deployed as a support.

Airbags and seat belt pretensioners that did not deploy and an Automatic Rollover Support Systems that did not deploy

Do not damage gas generators of airbags that did not deploy. Do not cut into airbag modules.

- Avoid any damage to the control module for safety systems over the course of rescue operations. The location of the control module can be found in the rescue sheets. As a rule, the control module is installed on the center tunnel, near the shift lever.
- Do not place any objects on airbag modules that did not deploy or an Automatic Rollover Support System that did not deploy.
- Avoid exposing airbag modules to heat, e.g. by using flame cutters. The gas generator in the airbag has a self-ignition temperature of approx. 200 °C. If vehicles are on fire, this is why the airbags deploy after being exposed to heat for a long period.
- Do not damage seat belt pretensioners that did not deploy, if possible.
- Caution when tipping or lifting the vehicle when the ignition is switched on and the battery is connected. An Automatic Rollover Support System that did not deploy may be activated.



There is a description in chapter 9, “Important additional information”, that specifies which safety systems (airbags, seat belt pretensioners, Automatic Rollover Support System, active pedestrian protection system) are installed in today’s vehicles.

Body reinforcements

A higher level of safety for the vehicle occupants can be achieved by means of a passenger cell that is designed for rigidity in particular. Higher-strength and hot-formed steels, thicker walls and a multi-layer shell are used in vehicle construction. These areas should be primarily avoided when rescuing vehicle occupants that were involved in an accident in today's vehicles, and correspondingly powerful hydraulic cutting equipment must be used.

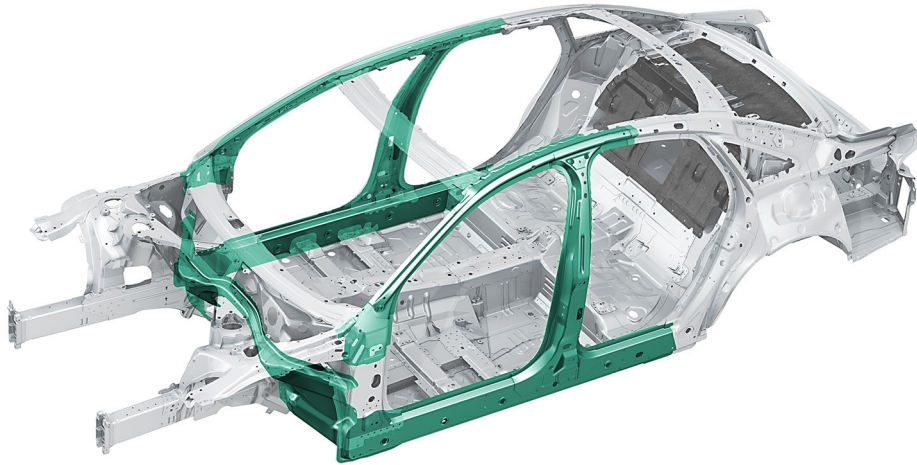

Body with reinforced passenger cell



Indicates high-strength areas on the rescue sheets.

The side members

Special steels are used in today's vehicles to reinforce the side members. These are used to increase safety in the event of side collisions, especially in the event of a collision with a pole.



Hot-formed steel can only be cut using powerful cutting tools.



Information on the position of reinforcements can be found in the vehicle-specific rescue sheets.

4. Access to the occupants

The A-pillar

In convertibles in particular, the body is additionally reinforced in order to achieve corresponding rigidity in the body even without a roof. Tube reinforcements may be installed at various points of the vehicle, including in the A-pillar, in order to improve the protective space together with the Automatic Rollover Support System should the vehicle overturn.

It may also be possible to open the convertible roof (a fabric roof is usually installed) by conventional means or by pushing up the roof with a rescue cylinder.

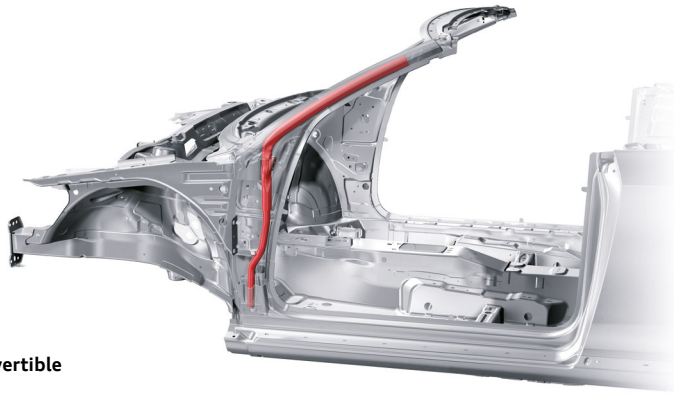

A-pillar reinforcement in the convertible



It is only possible to cut through the A-pillar in the area of the A-pillar reinforcement with high-power rescue equipment.



The position of specific reinforcement measures in the individual vehicles can be found in the rescue sheets!

The B-pillar

The B-pillar in particular is reinforced by the use of higher-strength and hot-formed sheet metal and a multi-layer shell. In addition, today's B-pillars have a larger cross-section.

The pillar is additionally reinforced in the area of the belt guide, making it more difficult to cut it. Therefore, these areas should be specifically circumvented.

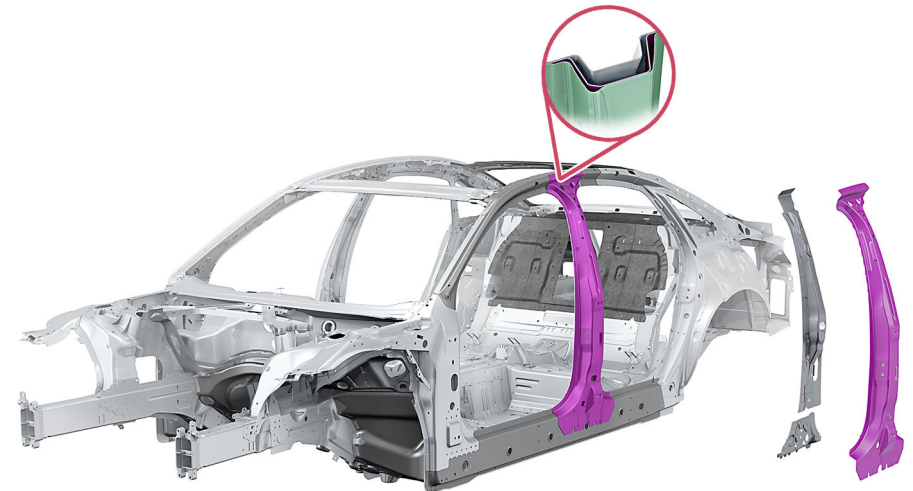

B-pillar with multi-layer shell



It is easiest to cut through vehicle pillars in the area above the safety belt height adjuster! The lower part of the pillar can also be cut through, but it should be noted that the cross-section of the pillar is very large, and that the seat belt pretensioner is usually located here.

4. Access to the occupants

Side impact protection

Side impact protection is installed in the doors. The tubes or profiles are installed horizontally or diagonally behind the outer door panels.

These high-strength profiles can be cut using high-power cutting devices.

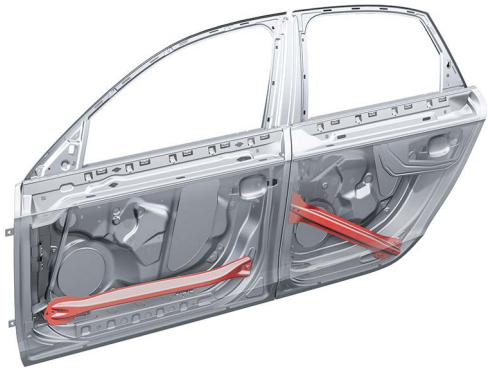

Side impact protection in the doors



The position of specific reinforcement measures in the individual vehicles can be found in the rescue sheets!

Glazing

Audi vehicle windows are made of single pane safety and laminated safety glass. The windshield is made of laminated safety glass (LSG) and the side and rear windows and panoramic roofs are made of single pane safety glass (SPSG). The side and rear windows may, optionally, also be made of laminated safety glass (LSG).

Single pane safety glass (SPSG)

Single pane safety glass (SPSG) is tempered glass that can withstand high loads. If the load is too high, it bursts into many pieces.

Single pane safety glass is used for side windows, rear windows, the sliding sunroof and panorama tilting sunroof.

	<p>Intact windows can suddenly burst during rescue operations on the vehicle. Depending on the accident situation and the extent of the rescue operations, the windows should be removed first. Windows can be removed by means of a point load, e.g. with a spring center punch or an emergency hammer. The windows should be secured first.</p>
---	---

Laminated safety glass (LSG)

Laminated safety glass consists of two glass panes and an intermediate layer of film. The panes of glass remain largely intact when damaged. They are used for windshields and for side windows in some cases. The windshields are bonded to the body.



	<p>As laminated glass windows cannot suddenly burst, they only have to be removed if it is necessary for the rescue operations. Laminated glass windows can be removed using special glass saws or hooligan tools.</p>
---	--

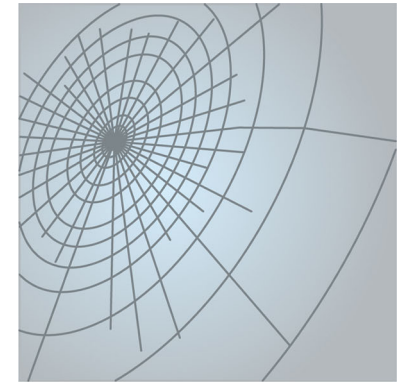

Single pane safety glass



Laminated safety glass

	<p>Protect the occupants from shards of glass before removing the glass panes.</p>
	<p>Information about the window versions installed are also described in the respective rescue sheets for the newer models.</p>

4. Access to the occupants

Driver seat and steering wheel height and forward/back adjustment mechanisms

The seats and steering columns in Audi vehicle models can be operated either mechanically or electrically.

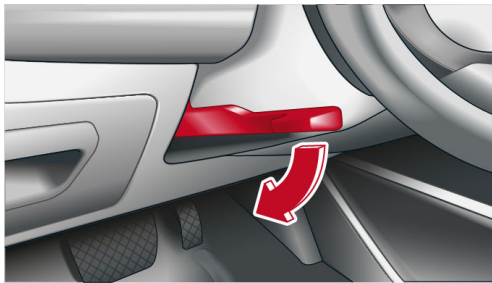

Manual steering wheel position adjustment



Electric steering wheel position adjustment

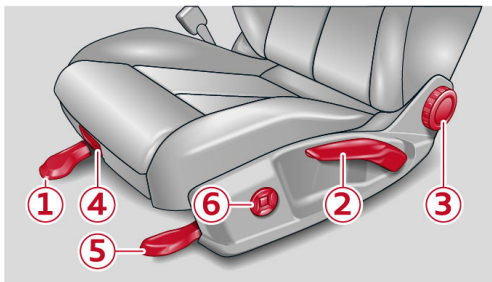

1 Forward/back adjustment
2 Height adjustment
3 Backrest adjustment
4 High support adjustment
5 Adjustment of seat cushion inclination
6 Lumbar support adjustment

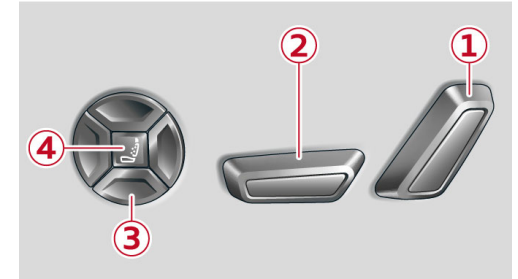



1 Backrest adjustment
2 Forward/back and height adjustment
3 Lumbar support adjustment
4 Massage adjustment

Electric convenience systems

Depending on the model series and vehicle equipment, Audi vehicles feature a large range of convenience systems that are operated electrically, such as:

- Electric doors
- Window regulators
- Electric sunroof
- Electric seat adjustment
- Electric steering column adjustment
- Electric release, opening and closing of the luggage compartment

After disconnecting the battery/batteries, these systems cannot be operated!

	In the event of accidents in which airbag deployment occurs, electrically operated doors and flaps are automatically unlocked.
	To the extent possible, the electrical convenience systems should be used to help with rescue operations before disconnecting the battery!
	The battery should only be reconnected to the vehicle electrical system by workshop personnel.

5. Stored energy/liquids/ gases/solids

Energy storage device for vehicle drive

Audi models comes with different drive concepts. Depending on the drive concept, fuel tanks (gasoline and diesel fuel) or batteries are installed in the vehicle as energy storage devices or fuel tanks.

Hybrid vehicles not only have a battery (48 V DC or high-voltage) but also a fuel tank. Fully electric vehicles only have one large high-voltage battery. An overview of the electric drive versions found at Audi is shown in chapter 1, "Identification/recognition".

Regardless of the drive system, each vehicle has one or several low-voltage batteries for the vehicle electrical system.



The installation positions of the fuel tanks, natural gas fuel tanks and batteries are shown in the rescue sheet.

Vehicles with a high-voltage system

In the context of vehicle technology, the following voltage levels are referred to as “high voltage”:

- Greater than 60 volts for direct current (DC)
- Greater than 30 volts for alternating current (AC)

High-voltage components

Along with the high-voltage battery, the electric motors, the external charging socket and the high-voltage distributor/control unit, which is known as the power electronics, a number of auxiliary units such as the high-voltage air conditioner compressor and supplementary heater are operated using high voltage and are connected to each other by high-voltage cables. All high-voltage cables or the high-voltage connectors have been fitted with orange insulation in the visible areas.

The components listed may also be installed in a vehicle multiple times. All other electrical components, such as lighting, vehicle electronics etc. are supplied with power from the 12 V vehicle electrical system.

General example of a high-voltage system:

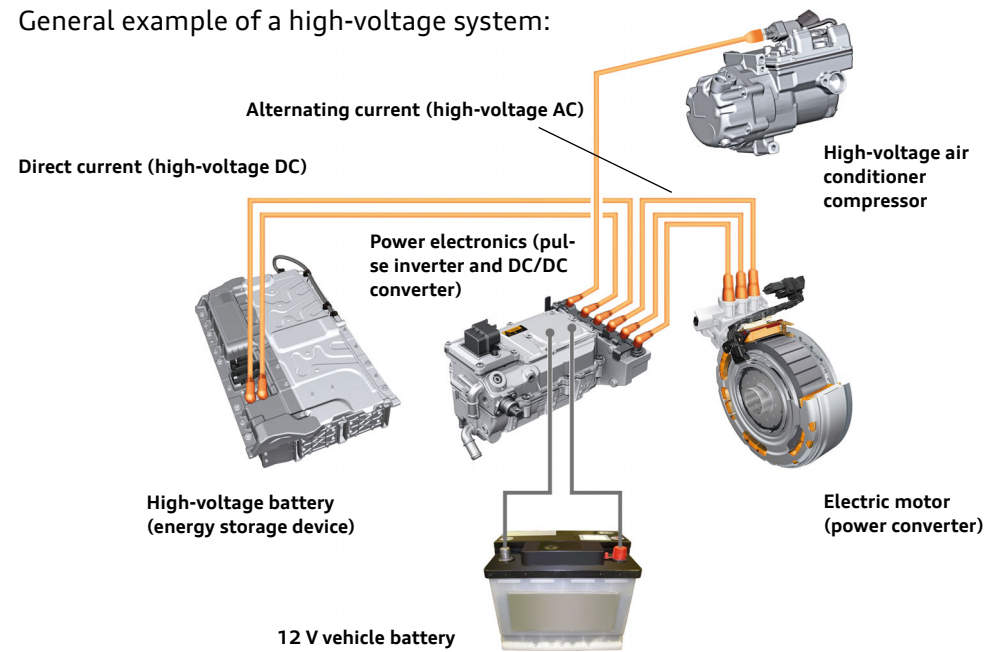

The installation positions of the high-voltage components and the route taken by the high-voltage cables are shown in the rescue sheet.



Audi Q4 e-tron

SUV inkl. Sportback, ab 2021

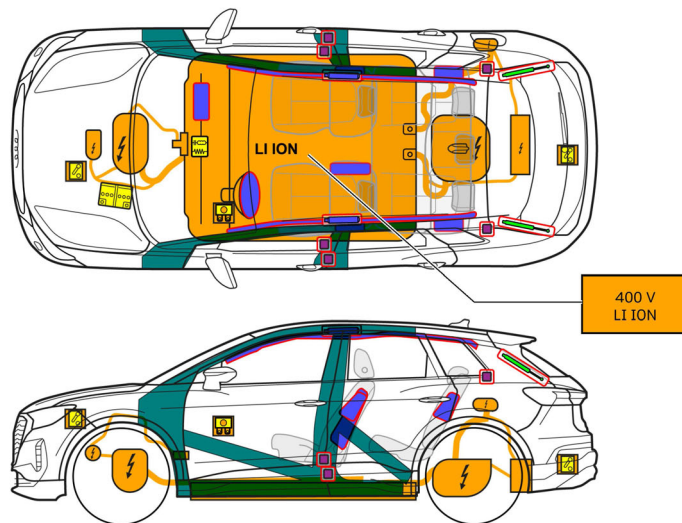

400 V
LI ION

Hinweis: Es ist die maximal mögliche Ausstattung abgebildet.

	Airbag		Gasgenerator		Gurtstraffer		SRS Steuergerät		Aktives Fußgängerschutz-System
	Automatisches Überrollschuttsystem		Gasdruckfeder / vorgespannte Feder		Hochfeste Bereiche		Besondere Aufmerksamkeit		
	Niedervolt-Batterie		Niedervolt-Kondensator		Treibstofftank		Gastank		Sicherheitsventil
	Hochvolt-Batterie		Hochvolt-Leitung		Hochvolt-Trennung		Sicherungsdose, Deaktivierung Hochvoltsystem		Hochvolt-Kondensator
	Hochvolt-Trennung an Niedervolt		Sicherungsdose, Deaktivierung HV-System an Niedervolt		Hochspannungskomponente				

Zusätzliche Informationen

Dokumentnummer
rds_au_316_001_de

Version
02/2021

Seite
1 von 4

High-voltage safety concept

The electrical components in the vehicle, such as the power electronics, the electric motor, the high-voltage battery and auxiliary units such as an electric air conditioner compressor operate in a voltage range that is higher than 60 volts of direct current (DC). They are connected using high-voltage cables and their insulation is identified by the warning color orange, as the voltage level and the hazard potential is higher than it is for the usual direct current (DC) from the 12 V or 48 V system in conventional vehicles.

All cables that conduct direct current of more than 30 volts are also identified by the warning color orange. If an insulation fault occurs, for example due to damage from outside, this is identified by the system; the reaction can range from the mere display of an insulation fault to a shutdown of the entire high-voltage system.

If handled incorrectly, the high voltage in the high-voltage system presents a potential hazard. The vehicle therefore has a comprehensive safety concept. The key principles of the safety concept are explained in the following chapter.

Galvanic isolation

The high-voltage system is galvanically isolated from vehicle ground. That means that there is no direct electrical connection between the active parts of the high-voltage system and the vehicle body.

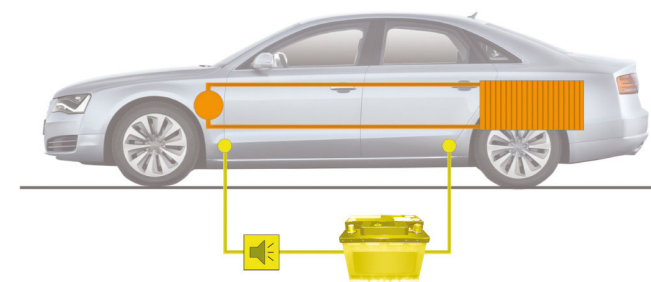

5. Stored energy/liquids/gases/solids

Accidental contact protection

The entire high-voltage system is isolated from the 12 V network and the body, and features accidental contact protection.

Equipotential bonding

The metal housings of all high-voltage components are designed to conduct electricity to the body. This ensures that even in the event of a fault, there will be no hazardous contact voltage on the metal housing.

High-voltage cables

All high-voltage cables feature orange insulation. The orange color of the insulating sleeve provides a clear visual signal. The high-voltage cables are, in part, protected from damage by additional covers and hoses.

Short-circuit monitoring

In the event of a short circuit or excess current, the overcurrent protection device (fuse) is tripped and disconnects the flow of current.

Discharge of residual voltages

The discharge circuit in the high-voltage system ensures that the high-voltage system is usually de-energized after around 20 seconds in the event of an accident involving seat belt pretensioner or airbag deployment, or when an unexpected malfunction occurs.

In all other cases, the high-voltage system can be deactivated by operating an disconnect high voltage device. The high-voltage system is also de-energized around 20 seconds after operating the disconnect high voltage device in this case too.

Isolation monitoring



Isolation monitoring, which is monitoring that the high-voltage system is not connected to the body, involves periodic checks of the isolation resistance of the high-voltage system.

Malfunctions are indicated by means of a warning message, and the driver is warned when a yellow or red lamp lights up in the instrument cluster and an acoustic signal sounds.



Shutdown in the event of a crash

Both battery poles feature one contactor each with a safety cut-off function, which closes when the high-voltage system is operating. In the event of an accident involving seat belt pretensioner and/or airbag deployment, the high-voltage battery receives a crash signal to open the contactors. The contactors on the high-voltage battery open, and the high-voltage system outside the battery discharges. The high-voltage connections on the high-voltage battery and all high-voltage components are then de-energized. In a number of vehicles, a pyrotechnic fuse triggers the shutdown following the arrival of the crash signal, and disconnects the battery voltage of the high-voltage battery.

The vehicle-specific rescue sheets for hybrid vehicles and electric vehicles include information about how the high-voltage system and the vehicle can be deactivated if automatic crash shutdown does not occur.

	Improper handling of high-voltage components and high-voltage cables presents a danger to life due to the high voltage and the flow of current through the human body that could potentially occur.
	Even after deactivation of the high-voltage system, there is still voltage in the high-voltage battery. The high-voltage battery must not be damaged or opened. Danger to life!
	When working with hydraulic rescue equipment, when lifting, stabilizing, towing or pulling the vehicle, the position of the high-voltage components and high-voltage cables must be observed (see vehicle-specific rescue sheet).

5. Stored energy/liquids/gases/solids

	<p>Do not touch, cut or open any damaged high-voltage components and/or high-voltage cables! Wear appropriate protective equipment! Cover any damaged components with suitable equipment, e.g. insulating blankets.</p>
	<p>It takes around 20 seconds for the high-voltage system to be de-energized after shutdown/deactivation.</p>

Warning labels for high-voltage components

All high-voltage components are marked by clear warning stickers. The high-voltage cables are an exception, as they are immediately visible due to the orange warning color of the cable sheaths.

Three types of warning stickers are used:

- Yellow stickers with the warning symbol for electrical voltage
- Stickers with the “Danger” lettering on a red background

The yellow stickers indicate the high-voltage components that are installed near the sticker or hidden under covers.

The warning stickers with the “Danger” lettering identify the high-voltage components directly.



Examples of warning stickers in high-voltage vehicles.

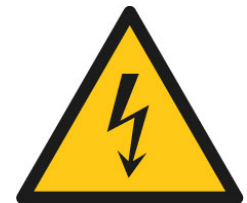

The high-voltage battery

High-voltage batteries are rechargeable batteries. Different battery types are used depending on the manufacturer and the vehicle. They differ in the chemical components used in the battery cells for anode, cathode, and electrolyte, as well as the structure of the battery cell (round, prismatic, pouch).



The high-voltage batteries used at Audi are lithium-ion batteries. The high-voltage battery is placed in a stable housing in areas in the vehicle that provide the best protection against deformation in most crash situations. The sizes and the fitting locations of the high-voltage batteries differ according to vehicle type. A fully electric vehicle requires a larger high-voltage battery than a hybrid vehicle.

The high-voltage battery is usually bolted under the center of the vehicle as a load-bearing body component in electric vehicles. The high-voltage battery is usually found in the rear vehicle area (in front or behind the rear axle) in hybrid vehicles.

The high-voltage battery in both hybrid and electric vehicles is comprised of battery cells connected in series which, in turn, are interconnected to form modules. Several modules are installed in a metal housing together with the peripheral equipment. The housing is connected to the vehicle by an equipotential bonding cable.

All high-voltage batteries are installed in a sturdy housing to protect the battery cells in the event of an accident and avoid the escape of battery electrolyte from defective battery cells.

	Depending on the vehicle version/equipment, the high-voltage battery may be comprised of several battery packages.
---	--

	In addition to the high-voltage battery, Audi electric vehicles also have one or several 12 V vehicle electrical system batteries.
	Due to the large number of different battery types with their different chemical components and due to the ongoing developments in rechargeable battery technology, the specific hazards and potential reactions associated with batteries cannot be explained in detail in this guide.

In the event of damage to, or overheating of, the high-voltage battery, exothermic chemical reactions may occur (thermal runaway): these reactions cause the battery cells to heat up quickly. This causes the battery to begin to burn and toxic vapors to be released.



Important information about this can be found in chapter 6, “In case of fire”. Information on how to deal with the energy stored in the battery is also included in chapter 8, “Towing/transportation/storage”.

5. Stored energy/liquids/gases/solids

Lithium-ion battery disconnected from the vehicle

If the high-voltage energy storage device and/or parts of it are disconnected from the vehicle in the event of an accident, it can be assumed that the high-voltage energy storage device presents an electrical, chemical, mechanical and thermal hazard.

The following points must be observed:

	If high-voltage energy storage devices, high-voltage components or high-voltage cables are damaged, e.g. there are open components or torn cables, then contact with these damaged areas must be avoided at all costs!
	When working with hydraulic rescue equipment, when lifting, stabilizing, towing or pulling the vehicle, the position of the high-voltage components and high-voltage cables must be observed (see the vehicle-specific rescue sheet).
	If work in these areas cannot be avoided, then damaged parts or high-voltage energy storage devices must be covered so they are electrically insulated. In this case, using an electrically insulated, malleable blanket is recommended (undamaged plastic film or another suitable, electrically insulating blanket, e.g. in accordance with IEC 61112).

When a high-voltage energy storage device has been disconnected from the vehicle, there may still be other parts of the overall energy storage system in or on the vehicle.

Components of high-voltage energy storage devices that have been disconnected may only be lifted from the ground with electrically insulating equipment!



Escaping electrolytes from damaged high-voltage insulation are irritating, combustible and potentially corrosive. Please wear the corresponding protective equipment!

Liquids that escape from high-voltage energy storage devices are usually coolants.
There are only small volumes of electrolytes (milliliters) in the individual cells.



Work should only be carried out with the helmet visor folded down to protect the face.

5. Stored energy/liquids/gases/solids

The following images show a number of examples of different installation concepts for the high-voltage battery in Audi vehicles. The exact installation position of the high-voltage battery can be found in the rescue sheet for the respective model.

Differences in installation concepts for the high-voltage battery

High-voltage battery in the underbody with addition package at the rear (Audi e-tron)

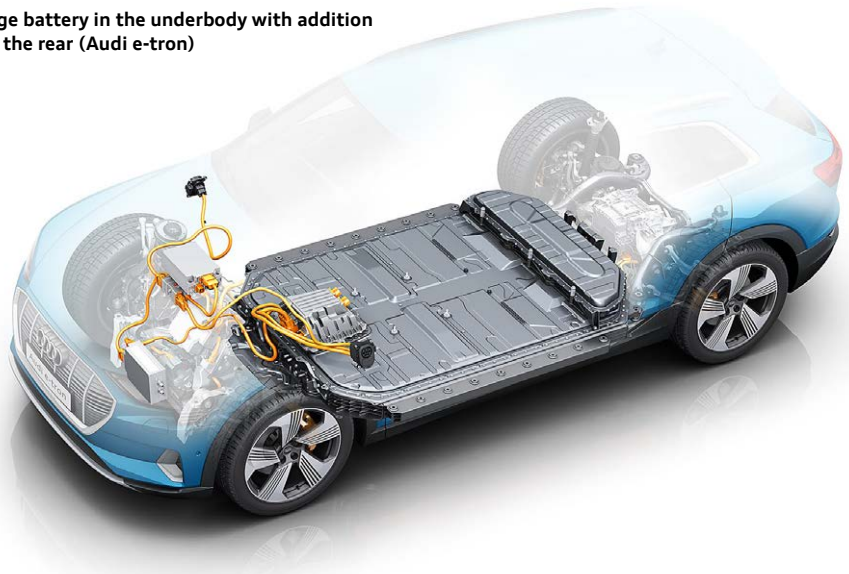

Audi e-tron rescue sheet

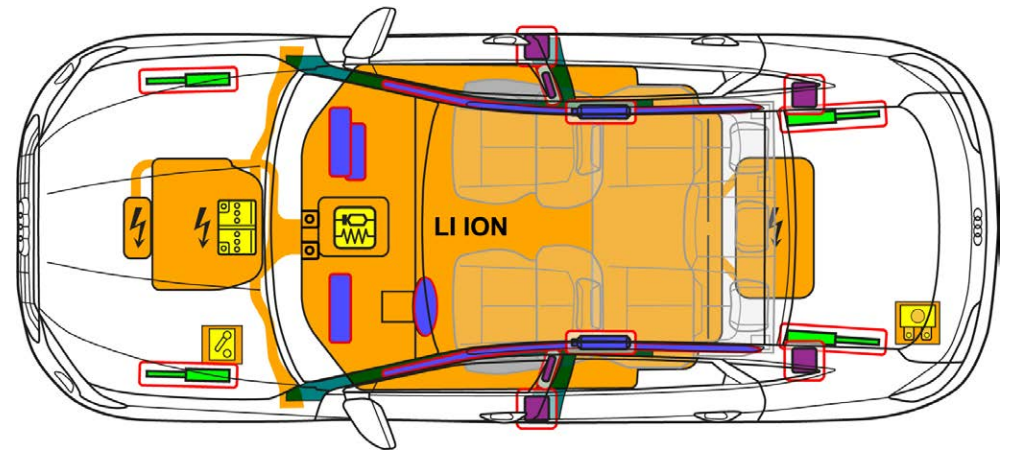

Differences in installation concepts for the high-voltage battery

High-voltage battery in the underbody with "foot garage" for the occupants in the rear (Audi e-tron GT)

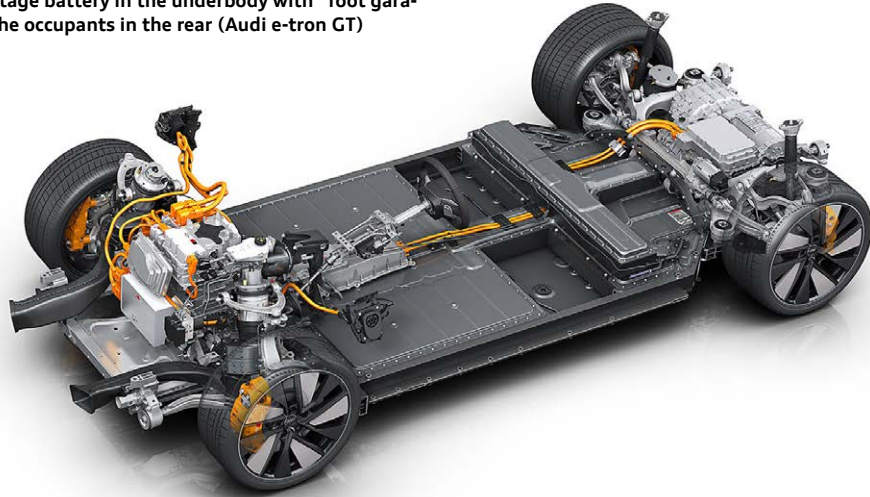

Audi e-tron GT rescue sheet

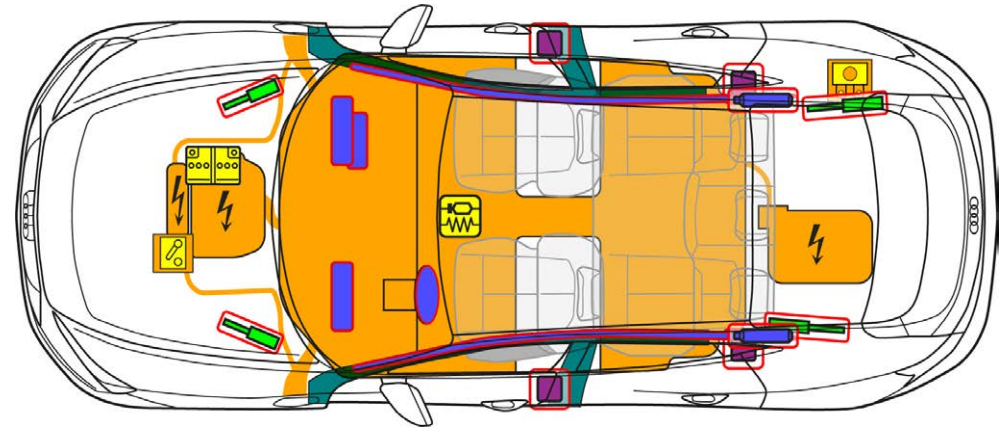

High-voltage battery in the underbody (Audi Q4 e-tron)



Audi Q4 e-tron rescue sheet

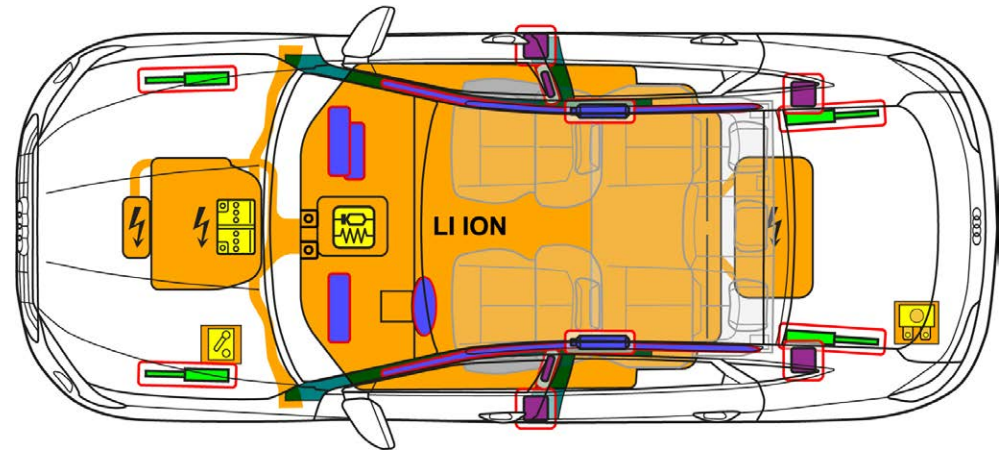

Differences in installation concepts for the high-voltage battery

High-voltage battery in the rear of the vehicle (Audi Q8 TFSI e)

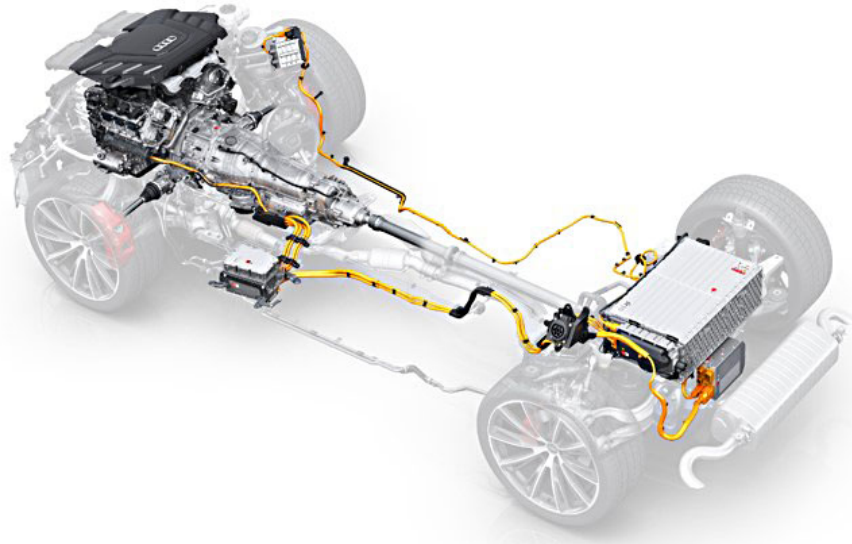

Audi Q8 TFSI e rescue sheet

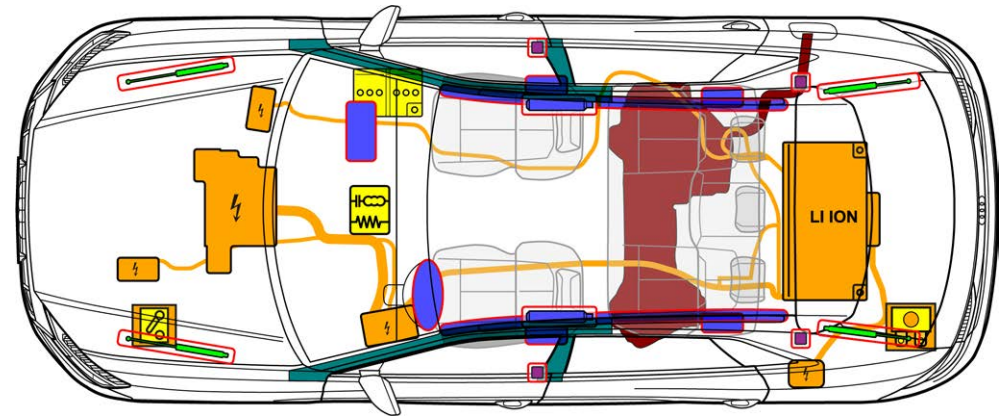

High-voltage battery in front of the rear axle (Audi A3 TFSI e)

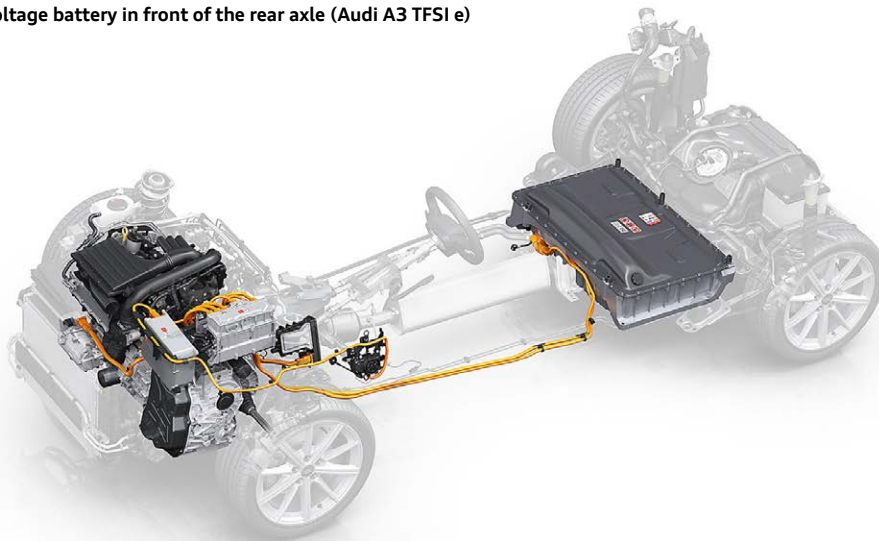

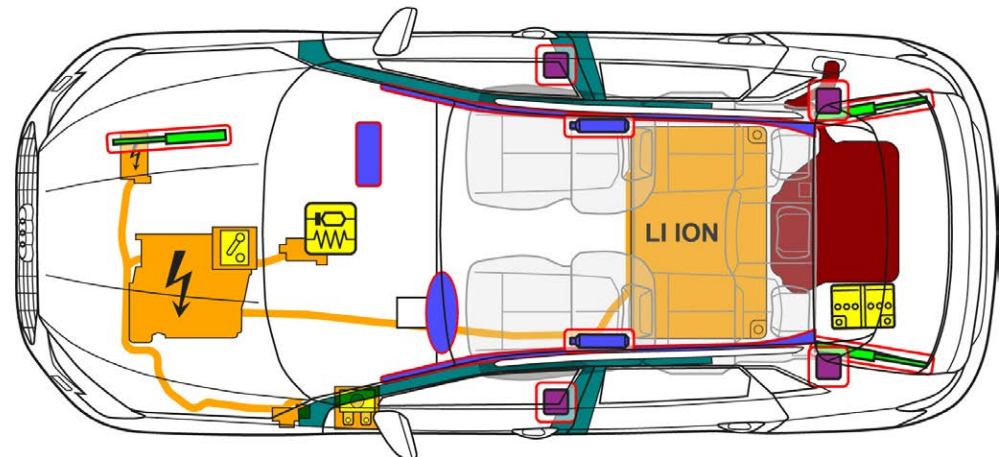

Audi A3 TFSI e rescue sheet



Battery information, general first-aid measures and aspects relevant to environmental protection:

Under normal operating conditions, the battery presents no danger of exposure to its content.

	<p>In the event that coolant escapes from the battery cooling system, there is a risk of a thermal reaction in the high-voltage battery. Monitor the temperature of the high-voltage battery!</p>
	<p>Avoid skin contact and inhaling electrolyte vapors as electrolytes are combustible, corrosive and irritant. Please wear the corresponding protective equipment!</p>
	<p>Contaminated extinguishing water is dealt with in accordance with the country-specific procedure for first and second responders.</p>

A/C system

Refrigerants R 134 a, R 1234 yf, R 744 and CO₂ are used for the A/C systems. More detailed information about different coolants can be found on the following website:

<https://www.dguv.de/ifa/gestis/gestis/stoffdatenbank/index.jsp>

Compressed air tanks

Compressed air tanks for e.g. the air suspension or A/C systems are installed in a number of Audi models. Do not damage these compressed air tanks or open them using force!

Flammable materials

These include, for example:

- Plastics
- Electrolytes
- Resins
- Magnesium
- Gases or other flammable liquids

6. In case of fire

Vehicle fire

In the event of a vehicle fire, all country-specific regulations, work instructions, authorities, and firefighting associations guidelines must always be observed and followed. If possible, the fire must be prevented from spreading to energy storage devices (fuel tanks, battery).

All standard and conventional extinguishing agents such as water, foam, CO₂ or powder can be used.

The extinguishing agent and method to use can only be decided at the scene, and this choice largely depends on the specific situation and available equipment.



If the airbags did not deploy in the accident, they may do so if the vehicle catches fire.



Fires in high-voltage vehicles

High-voltage vehicles are generally no more dangerous to deal with than gasoline or diesel vehicles, but some aspects may be different. Knowing these differences can be important for emergency operations following car accidents.

In the event of fires involving high-voltage vehicles, a distinction must be made:

Vehicle fire that has not spread to the high-voltage battery:

- Just like a passenger car with conventional drive, a “regular” fire in a hybrid or electric vehicle (HEV or BEV, where the high-voltage battery is not on fire) can be extinguished using all standard and conventional extinguishing agents, such as water, foam, CO₂ or powder, as required.

Vehicle fire that has spread to the high-voltage battery:

- Smoke, sparks or flames from the battery can indicate that the lithium-ion battery is also on fire.
If a high-voltage battery is on fire, use water to extinguish and cool the battery. In this case make sure to use plenty of water and try to get water into the high-voltage battery through the openings caused by the fire or collision.
The water jet should be aimed directly at the battery. The installation position of the high-voltage battery is shown on the rescue card for the model in question.

The decision for suitable measures should be made by the firefighters at the scene, since the appropriate action depends greatly on the given situation (e.g. how the fire has spread and the time arrival time of the firefighters) as well as the available equipment.

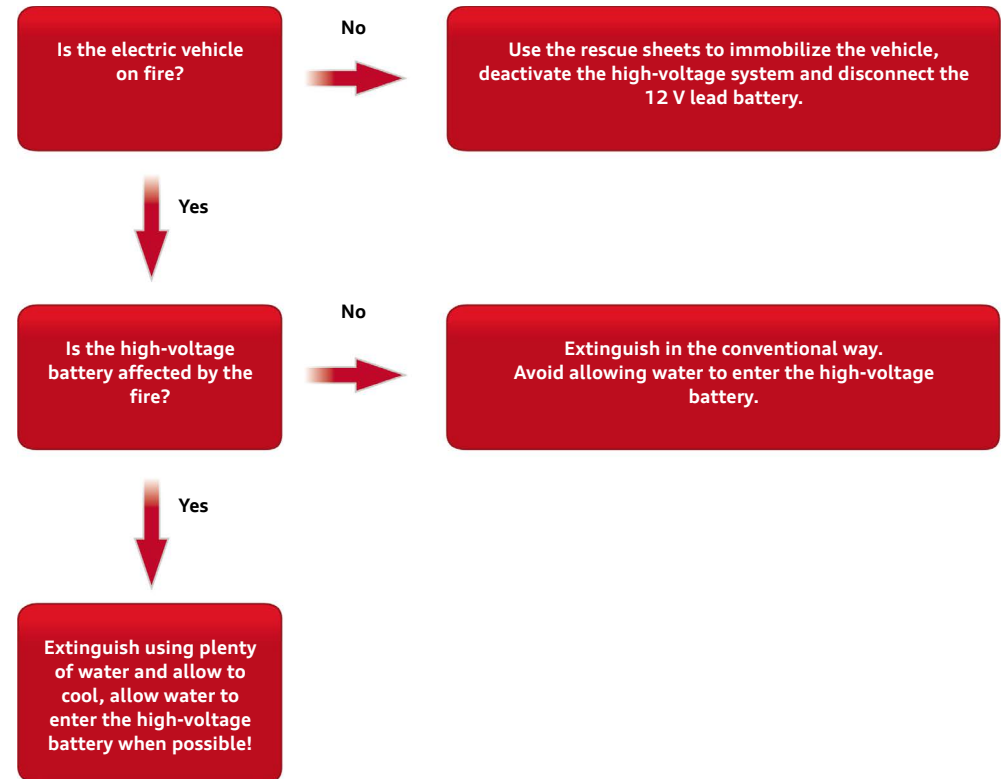

Flow chart for fires in electric vehicles.

A severely damaged lithium-ion battery (for example with a crushed, broken or cracked housing) may react to the effects of water or fire quickly, or it may take some time. Therefore, when working on a vehicle with a lithium-ion battery that was in an accident, remain vigilant for signs of a reaction (smoke, heat, noises, sparks etc.).

Protective and counter-measures must be taken if there is a reaction in the lithium-ion battery.
Just as with conventional vehicles, harmful smoke is produced when electric/hybrid vehicles catch fire. Therefore suitable protective equipment is recommended.

6. In case of fire



Due to its safety technology, the high-voltage battery will not explode.





If the high-voltage battery catches fire, it is likely to release gas because it has mechanical safety devices that open, for example, when the temperature and pressure increase due to a fire, thereby allowing a controlled “outgassing” to relieve the pressure.

Fires in vehicles with a high-voltage battery can be extinguished, as can fires in the high-voltage battery itself. According to the VDA accident rescue and recovery guide, water should preferably be used as the extinguishing agent, and is no different from fighting a fire in a conventionally powered vehicle.

If the undamaged high-voltage battery is involved in a fire, then large amounts of water are required to cool or extinguish a reactive battery. After a reaction, the lithium-ion battery must be cooled down with water until it is approximately the same temperature as the ambient temperature. We recommend using a thermal imaging camera or an infrared thermometer.

It must be extinguished or cooled using plenty of water.

	After the fire has been extinguished, there may still be hazardous voltages.
	Batteries that have not completely burnt out may ignite again. Vehicles in which a fire has been extinguished must be taken to a suitable storage site and be monitored.

	Stay a sufficiently safe distance away. An appropriate self-contained breathing apparatus must be worn!
	Vapors and gases can be suppressed by spraying a jet of water.
	Exposed or defective cells may burst and cause an exothermic reaction.
	A fire may break out some time after the accident, because the residual risk of delayed ignition cannot be eliminated. This applies in particular to damaged high-voltage energy storage devices (see also section 8 “Towing/Transportation/Storage”). An electrical hazard is also still possible. High-voltage components must not be touched and suitable protective equipment must be worn. High-voltage cables may have been damaged by the heat.
	Further information can be found in the respective rescue sheets.

7. In case of submersion

Vehicle under water

A vehicle that is submerged in water must be treated the same way as a vehicle that was in an accident and has been damaged.

The safety regulations must be observed and the procedure for eliminating direct hazards must be followed, see chapter 3.

High-voltage vehicle under water

- The risk of electric shock presented by the high-voltage system is not, in principle, higher when the vehicle is in water.
- The same information that appears in chapter 3 “Disable direct hazards/safety regulations” applies.
- The procedure for recovery is identical to the one for conventional vehicles. This also applies to bodies made of carbon fiber composite materials.

Source: German Association of the Automotive Industry (VDA), Accident Assistance & Rescue for vehicles with high-voltage systems, FAQ.



When water enters the high-voltage battery, this may trigger electrolysis, which can lead to oxyhydrogen deflagration.
The high-voltage system must be deactivated (see chapter 3 “Disable direct hazards/safety regulations”). Wear appropriate protective equipment!

8. Towing/transportation/storage

Recovery of vehicles that have been in accidents

When loading, transporting and storing, the information on the rescue sheets must be observed.

Recovery of high-voltage vehicles involved in accidents from a hazardous area

Vehicles with high-voltage batteries should, as a matter of principle, be transported away on flatbed trucks.

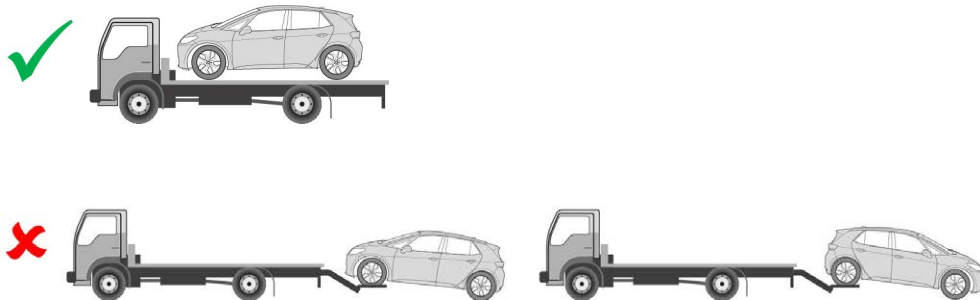

The high-voltage system must be deactivated before transport; see chapter 3 “Disable direct hazards/safety regulations”.

Before the vehicle is transported away (e.g. by a towing company), the condition of the lithium-ion battery must be checked again. The vehicle may only be loaded and transported away if the vehicle does not exhibit any signs of a reaction near the lithium-ion battery for an extended period, see the flow chart on the next page.

If the vehicle that was in an accident has a damaged or abnormal lithium-ion battery, the vehicle may only be loaded when the reaction has sufficiently ab-

ated and it can be assumed that no further reaction need be expected, see the flow chart on the next page.

Choose the shortest and least dangerous route possible. Avoid going through tunnels.



If required or in case of doubt, the tow truck may have to be accompanied by a fire engine.

Vehicles with a high-voltage battery that has been damaged should be transported to a safe storage site.



After transport, electric or hybrid vehicles that have been in accidents should be parked outside and not in enclosed buildings, at a sufficient distance from other vehicles, buildings, combustible objects or flammable surfaces.

Preference should be given to the use of designated “quarantine areas” at the storage site. Because there is still a theoretical risk that the lithium-ion battery may react, the accident vehicle must be taken to a suitable outdoor site and left there. The parking site must be marked accordingly (signs/barriers). There must be a distance of at least five meters from other vehicles, buildings or combustible objects. The distance can be smaller if appropriate measures such as a fire barrier are in place.

Those responsible at the towing company, repair workshops and, if necessary, the disposal company must be told about the characteristics and hazards of the vehicle!

	Lithium-ion batteries can ignite again after the fire has been extinguished!
	If the vehicle has been in an accident or if the high-voltage battery is damaged or in an abnormal condition, deactivate the high-voltage system (see chapter 3). Park the vehicle at a safe distance of at least 5 m away from buildings and other vehicles (quarantine area).

8. Towing/transportation/storage

	Vibration during transport can cause high-voltage batteries to re-ignite.
	Vibration during transport can cause high-voltage batteries to ignite again.
	Recommendations for specific vehicles are described on the respective rescue sheets.

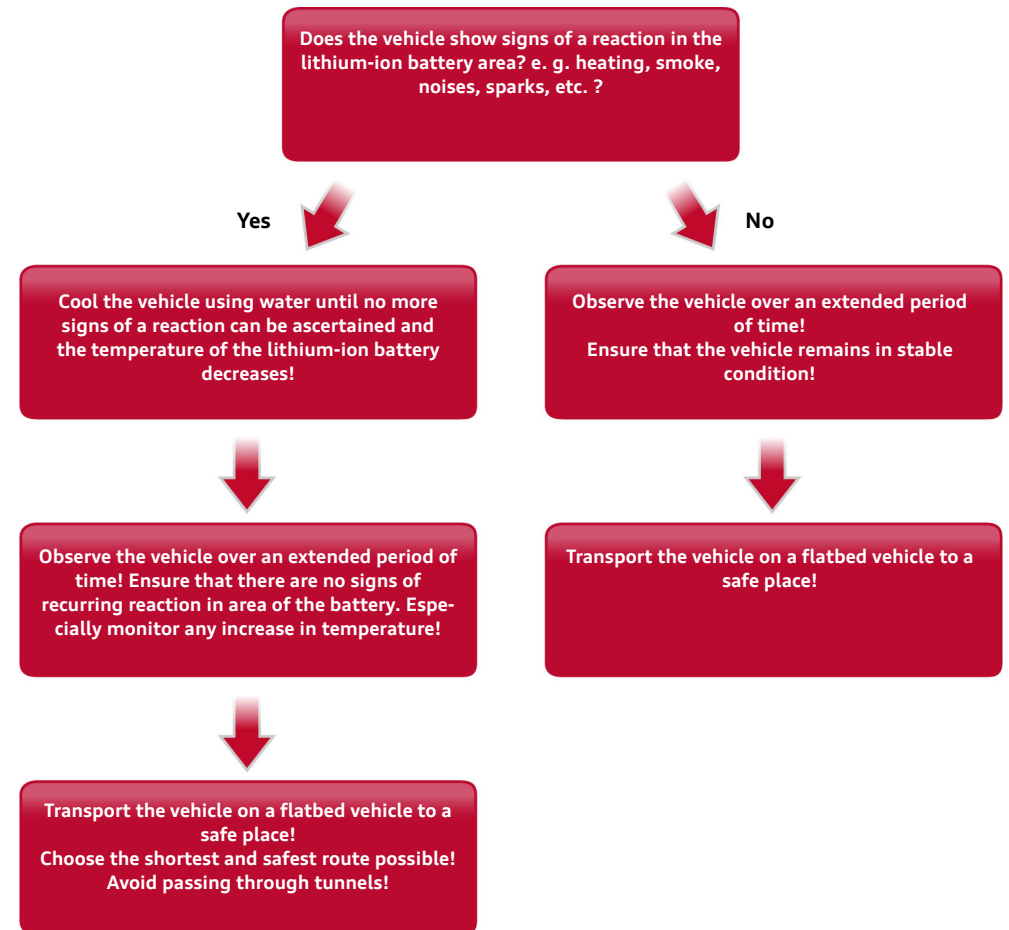

The condition of the lithium-ion battery shall be checked before the vehicle is removed.

Manage or addresses „stranded energy“



Flow chart for towing electric vehicles.

8. Towing/transportation/storage

	Monitor the temperature using suitable devices such as an infrared camera for an extended period if possible!
	A large metal receptacle such as a container is recommended for transporting a high-voltage battery or parts of one that have been disconnected from the vehicle. The condition of the high-voltage energy storage device must be monitored (e.g. for smoke, noises, sparks, heat) and it must be ensured that the metal container can be quickly flooded with water.
	For more information, see chapter 5 “Stored energy/ liquids/gases/solids” (lithium-ion battery disconnected from the vehicle)..

9. Important additional infor- mation

Depending on the vehicle type and equipment version, today's vehicles can feature extensive passenger protection systems.

Airbag

A current vehicle with the maximum equipment features will have these main components:

- Airbags
- Airbag control unit
- Sensors
- Seat belt pretensioners and
- in convertibles, components that deploy the rollover bar

Pretensioned springs or pyrotechnics are deployed. The purpose of the electronics integrated into the airbag control unit is to detect vehicle deceleration and acceleration and to identify whether it is necessary to activate protection systems.

In addition to the sensors in the airbag control unit, sensors (e.g. crash sensors in the front doors) are used to detect vehicle deceleration or acceleration during an accident. Only once the information from all sensors has been evaluated do the electronics in the airbag control unit decide whether and when which safety components are activated. Depending on the nature and severity of the accident, only the seat belt pretensioners, for example, are deployed, or the seat belt pretensioners in combination with the airbags.

The control module is labeled in the rescue sheets as follows:

	Marking for airbag control unit in accordance with ISO 17840
---	--

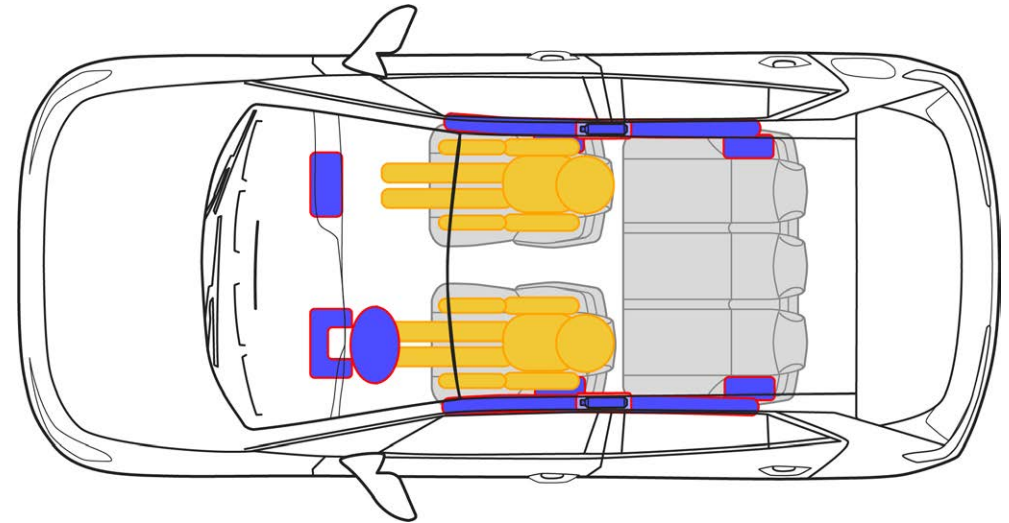

Airbags in today's vehicle models.

Only those safety systems that have a protective function in the specific accident situation are activated.

In addition to its main function of controlling the airbags, the airbag control unit can also have the following functions:

- Emergency release for central locking
- Switching on the interior lighting
- Switching off the fuel pump
- Switching on the emergency flashers
- Forwarding a signal for sending the e-call

Gas generators generate the quantity of gas required to fill the airbags and thereby inflate the airbags within milliseconds. The inflated airbags protect the seat-belted occupants from colliding with interior body contours (e.g. the steering wheel, the dash panel etc.) in the event of a serious accident.

Depending on the installation location and requirements, gas generators are used in different designs or with different operating principles.

9. Important additional information

The safety systems are activated in accordance with the type of accident or direction of impact

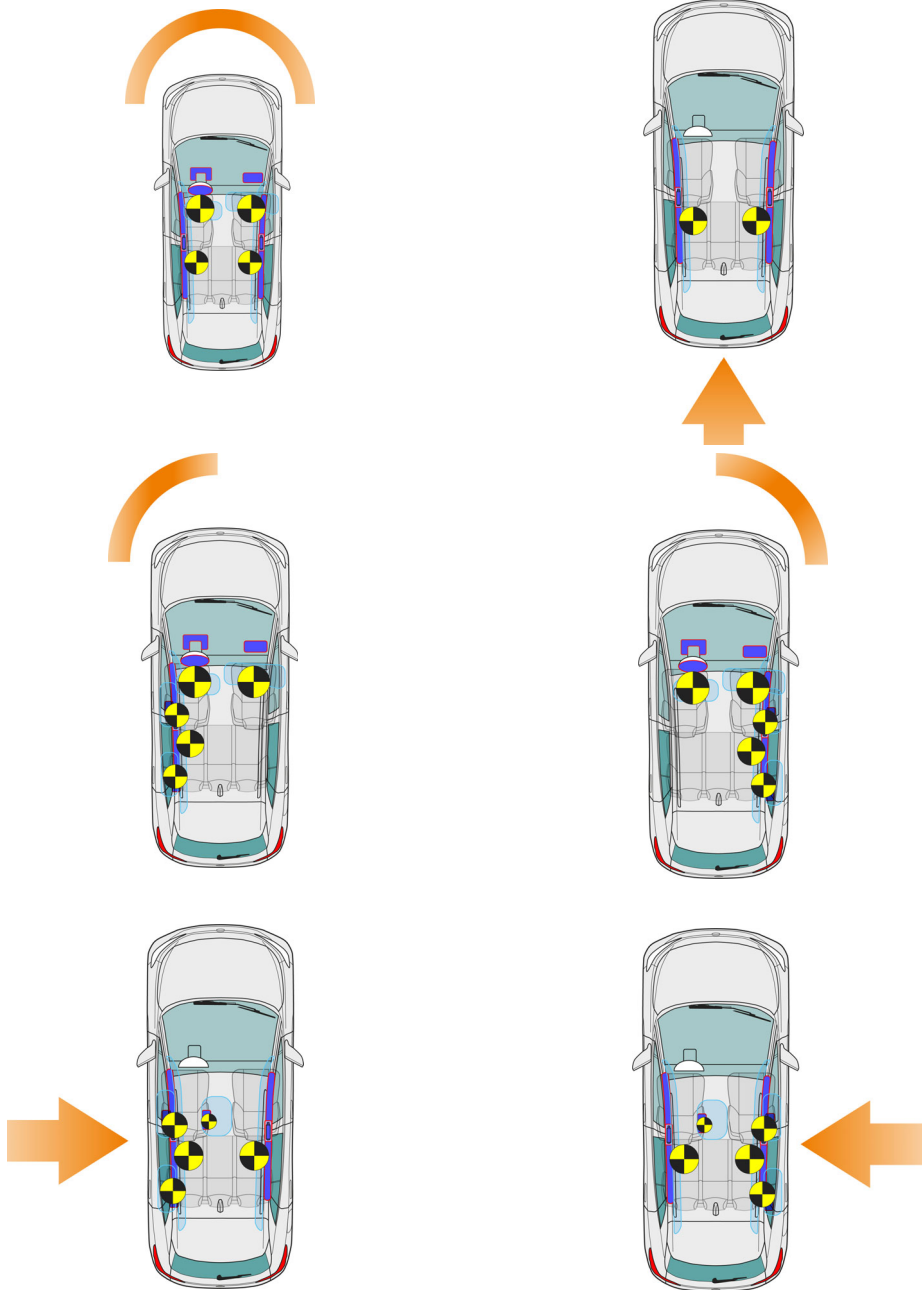

The safety systems are activated in accordance with the type of accident or direction of impact (ms = milliseconds).

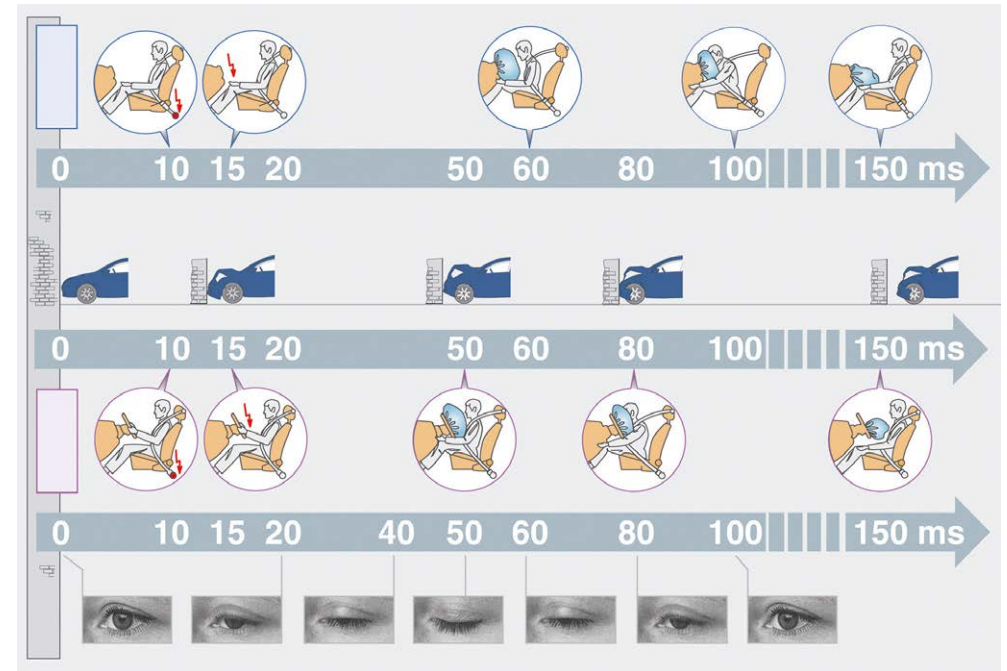

Airbags are labeled in the rescue sheets as a symbol, or as contours, as follows:

	<p>Driver's airbag, front passenger's front airbag, side or center airbag, knee airbag and head curtain airbag</p>
--	--

9. Important additional information

Front airbags

Driver's airbag

The driver's airbag unit essentially consists of a cap, an airbag and a gas generator. It is secured in the steering wheel and a contact unit provides an electrical connection to the airbag control unit.

The airbag is folded together under the cap, and its shape and size is designed to provide a protective barrier between the driver and the steering wheel once it is filled.

The driver's airbag is inflated by a gas generator. The unfolding airbag opens the cap on the steering wheel along a preconfigured tear seam and is filled with gas within a very short time. The entire process, from ignition of the gas generator to a fully inflated airbag only takes a few milliseconds.

Vents on the side facing away the driver are used to reduce the kinetic energy caused by impact of the upper body by allowing the filling gas to escape evenly.

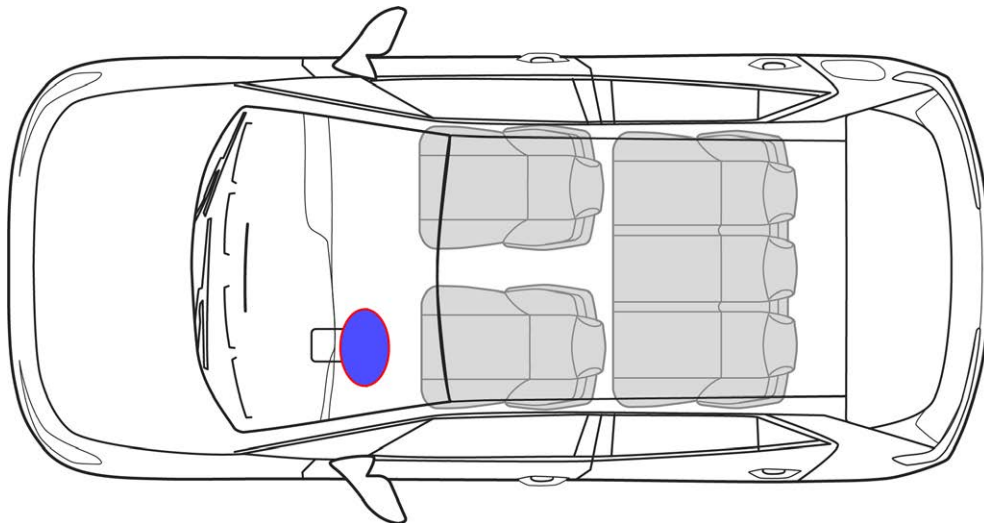

Front passenger's front airbag

The airbag unit for the front passenger is installed in the instrument panel in front of the front passenger seat. Due to the larger distance between the airbag unit and the occupant, the airbag for the front passenger's front airbag has a significantly larger volume. The effect of the front passenger's front airbag, how it functions and the deployment sequence are comparable to those of the driver's airbag.

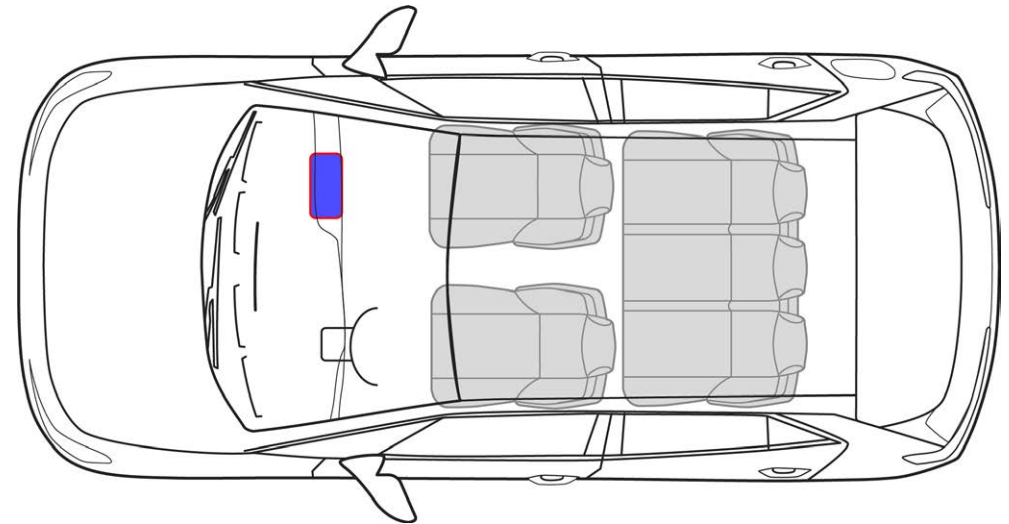

9. Important additional information

Knee airbag

The design of the knee airbag is comparable to the design of the front passenger's front airbag. It is installed in the footwell trim below the dash panel. The knee airbag is always deployed together with the driver's airbag. Single-stage gas generators are used to inflate the knee airbags. The ignition of the knee airbag reduces the risk of potential injuries in the knee and leg area for the occupants, and the occupant is involved in the vehicle deceleration earlier.

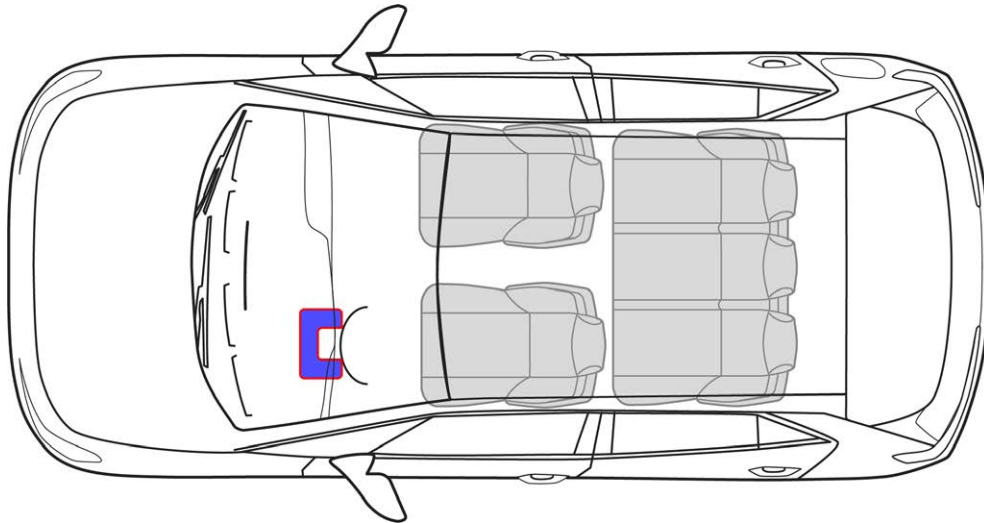

Side airbag

In the event of accidents at the side of the vehicle, side airbags protect the vehicle occupants' thorax and pelvis on the side of the vehicle that is struck, and reduce the forces acting on them. They inflate at the side between the upper body and the trim parts that protrude, and therefore distribute the forces acting on the occupants more evenly, who are thereby coupled to the intrusion movement at an early stage.

The side airbags are installed in the seat backrest of the driver and front passenger seat, as well as in the outer seats in the second seat row in a number of

Audi models. This guarantees that a uniform distance to the occupant is maintained in every seat position.

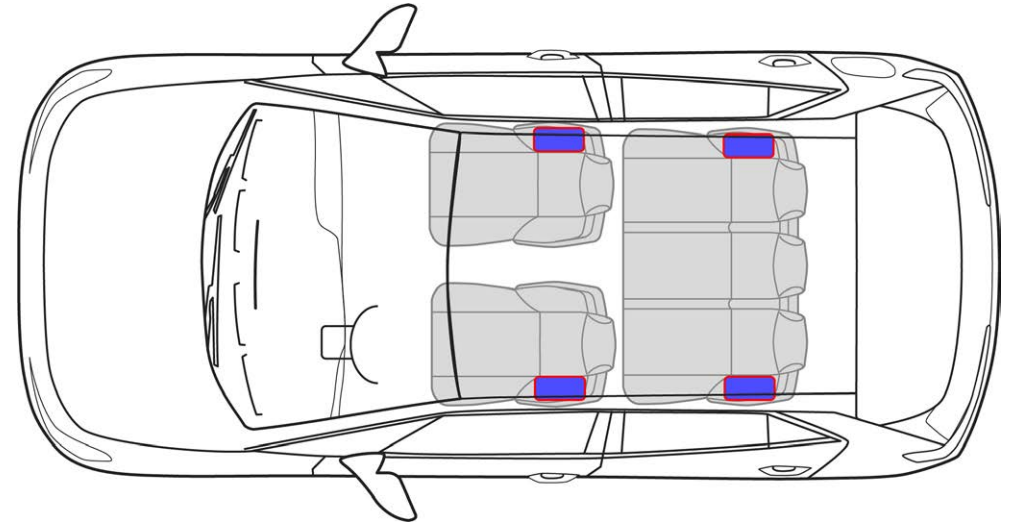

Head/thorax airbags

The head/thorax airbags for the driver and front passengers have been integrated into the respective backrests of the front seats. The design and the function is comparable to that of a side airbag.

They extend from the vehicle occupant's ribcage up to the head, and their installation is specific to convertibles, in which a head curtain airbag cannot be installed.

Head curtain airbags

Head curtain airbags are used to protect the head in the event of a side impact. They consist of an airbag with a large surface area, which usually extends from the A-pillar to the C-pillar in the vehicle's headliner.

Depending on the vehicle model, the gas generators may be installed in the roof area at the B-pillar or between the B-pillar and C-pillar, or between the C-pillar and D-pillar, or may be installed in the rear roof area. The exact installation position is described in the rescue data sheets.

In contrast to front and side airbags, the head curtain airbag may retain its internal pressure for some time following deployment in order to provide a protective effect if the vehicle rolls over or secondary collisions occur.

Both the side and head curtain airbags are deployed by the airbag control unit when a threshold value stored there is reached. A side impact is detected by lateral acceleration sensors or pressure sensors in the doors.

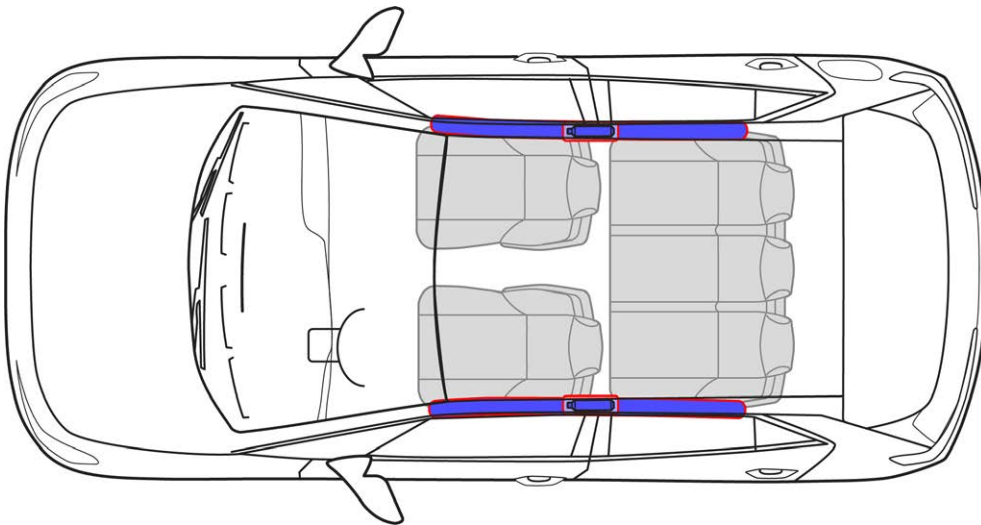

Airbag gas generators

Solid propellant gas generators

The solid propellant gas generators are comprised of a housing in which a solid propellant charge has been integrated together with an ignition unit. After ignition of the solid propellant, the filling gas that is produced is non-hazardous for the vehicle occupants.

Procedure:

- The igniter is activated by the airbag control unit.
- The propellant charge is ignited and burns off suddenly.
- The gas produced flows through the metal filter into the airbag.

Hybrid gas generators





The hybrid gas generators consist of a housing that combines a compressed gas stored under high pressure and a solid propellant charge with an ignition unit. The design and shape of the generator housing are adapted to the respective installation conditions. These generators are usually tubular in shape. The main components are the pressure vessel with the airbag filler gas and the propellant charge (solid propellant) integrated into the pressure vessel, or flange-mounted to it. The solid propellant is inserted in tablet or ring form. The stored and compressed gas is a mixture of inert gases, e.g. argon and helium. Depending on the design of the gas generators, the gas is pressurized to between 200 bar and 800 bar.

- When the solid propellant is ignited, the pressure vessel opens and a gas mixture is produced from the gas produced by the solid propellant charge and the inert gas mixture. The igniter is activated by the airbag control unit, and the propellant charge is ignited.

	<p>Do not damage the gas generators during rescue operations. The compressed gas in the pressure vessel and the pyrotechnic fuels can pose a potential danger to the first and second responders and the occupants.</p>
---	---

Seat belt pretensioners

In the event of a crash, seat belt pretensioners wind the belt in the opposite direction to its pull, thereby reducing the slack (play between the seat belt and the body). This prevents vehicle occupants from moving forward at an early stage (relative to the movement of the vehicle). A seat belt pretensioner can retract the seat belt by up to approx. 200 mm within approx. 10 ms. The seat belt pretensioners have been integrated on the inside the belt system. However, depending on the type of vehicle, they may be installed in a different place (e.g. in the B-pillar, in the side member next to the seat, or on the outside of the rear seat) and exhibit different functional principles. In some cases, two seat belt pretensioners are even used on one seat.

	<p>Seat belt pretensioners should therefore not be damaged by rescue equipment, when possible. Striking this area must be avoided!</p>
	<p>The belt also locks in place when the vehicle is at an acute angle, has overturned, or if the seat belt pretensioner has sustained any damage in the accident.</p>
	<p>Seat belt pretensioners with mechanical activation that were not activated may still be activated even after disconnecting the battery.</p>
	<p>If the situation allows, the seat belt should be removed or cut off as early as possible.</p>
	<p>Marking for belt pretensioners as per ISO 17840</p>

Installation versions

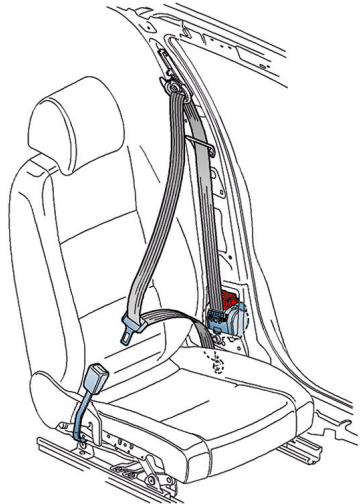
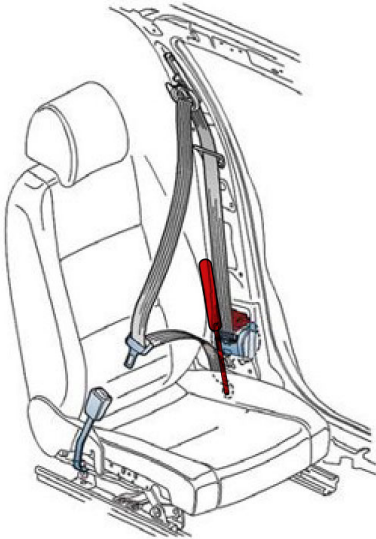
Version	Installation location
	<p>Driver/front passenger version 1 The three-point seat belt and seat belt pretensioner with electric or mechanical ignition activation form a unit for the front compact seat belt pretensioner, and are installed in the B-pillar.</p> <p>Driver/front passenger installation version 1 – compact seat belt pretensioner in the B-pillar</p>
	<p>Driver/front passenger version 2 The compact seat belt pretensioner (three-point seat belt with seat belt pretensioner) and lap belt pretensioners are both installed in the B-pillar (both seat belt pretensioners with electric ignition activation). The lap belt pretensioner is installed above the compact seat belt pretensioner.</p> <p>Driver/front passenger installation version 2 – compact seat belt pretensioner and lap belt pretensioner in the B-pillar</p>

Installation versions

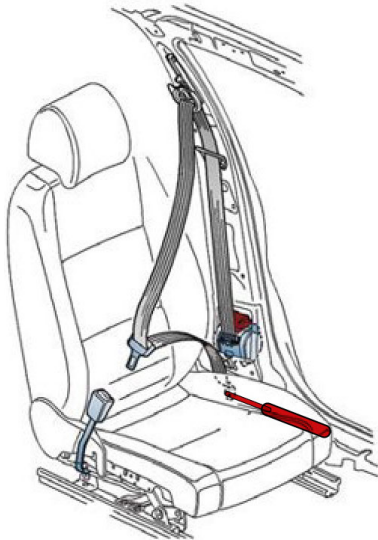
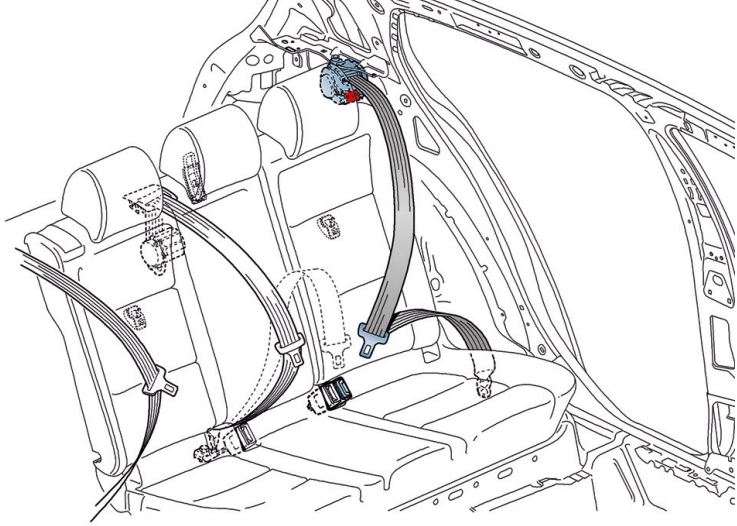
Version	Installation location
	<p>Driver/front passenger version 3 The compact seat belt pretensioner (three-point seat belt with seat belt pretensioner) and lap belt pretensioners are installed as self-contained units (both seat belt pretensioners with electric ignition activation). The lap belt pretensioner with electric ignition activation is installed on the side member/B-pillar.</p> <p>Driver/front passenger installation version 3 – compact seat belt pretensioner in the B-pillar, lap belt pretensioner near the side member/B-pillar</p>
	<p>Rear seat version 1 The three-point seat belt and seat belt pretensioner with electric or mechanical ignition activation form a unit for the rear compact seat belt pretensioner, and are installed behind the rear seat backrest.</p> <p>Rear seat installation version 1 – rear compact seat belt pretensioner near the C/D-pillar (in vehicles with seat belt pretensioner for the center rear seat, the compact seat belt pretensioner is in the backrest)</p>

Installation versions

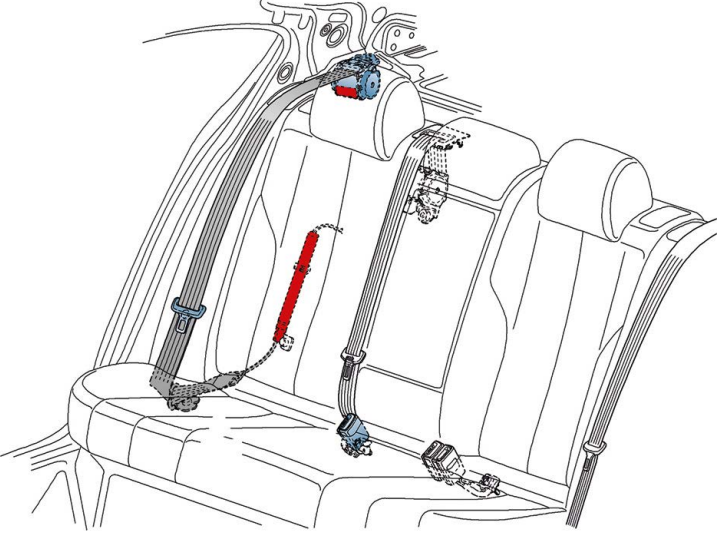
Version	Installation location
	<p>Rear seat version 2 The rear compact seat belt pretensioner (automatic belt with belt pretensioner) and the lap belt pretensioner are installed as self-contained units. The compact seat belt pretensioner with electric ignition activation is installed near the C/D pillar. The lap belt pretensioner with electric ignition activation is installed near the C-pillar wheel housing console.</p> <p>Installation version 3 – compact seat belt pretensioner and lap belt pretensioner near the C/D-pillar or C-pillar wheel housing console</p>



Automatic Rollover Support System

Convertibles must provide the greatest possible protection for occupants even when the roof is open. This is why an Automatic Rollover Support System is used that, in combination with reinforced A-pillars, provides a protective zone for the occupants. This can be rigid or dynamic.

The following functional principle is used by a dynamic system:

- There is a sensor in the airbag control unit that detects an impending rollover.

Together with other sensors installed in the control unit, the severity of the accident is determined and the Automatic Rollover Support System and seat belt pretensioners are deployed. The Automatic Rollover Support System is deployed as a precaution in the event of a front, side or rear impact causing a severe accident as soon as a seat belt pretensioner or airbag is deployed. It is deployed by the Automatic Rollover Support System activation unit. A pretensioned spring is used to move the bracket into the protective position within around 0.25 seconds, and the lock plate is used to lock it in the extended position.

	<p>If the rear window is still intact when the Automatic Rollover Support System is deployed, the Automatic Rollover Support System will not break the rear window. If the window is removed as part of the rescue operation, the rollover bar is pushed another 10 cm upward. It may strike first and second responders, and shards of glass may be thrown into the air.</p>
	<p>Marking for Automatic Rollover Support System as per ISO 17840</p>

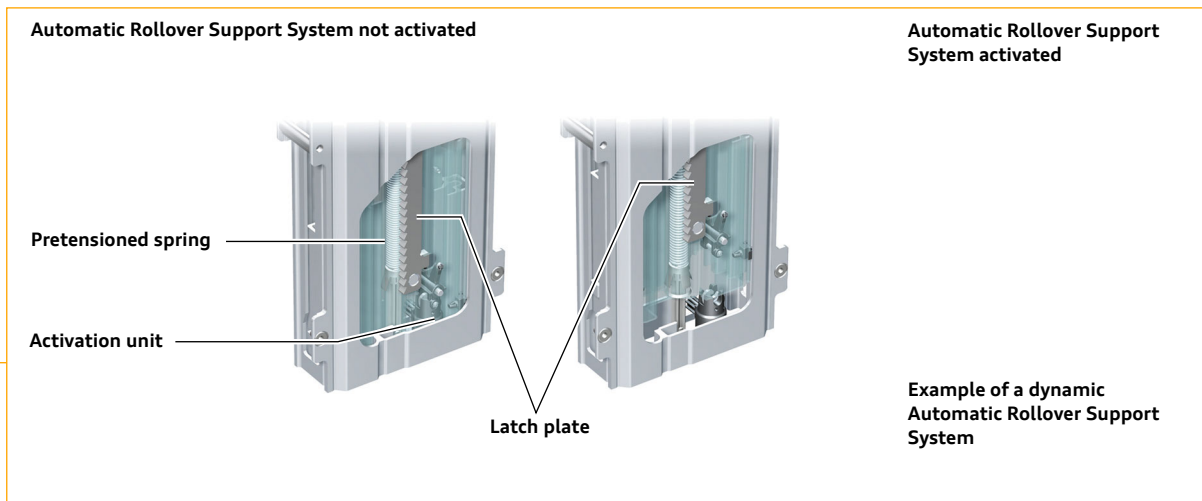
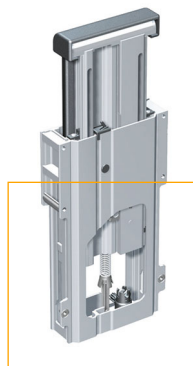

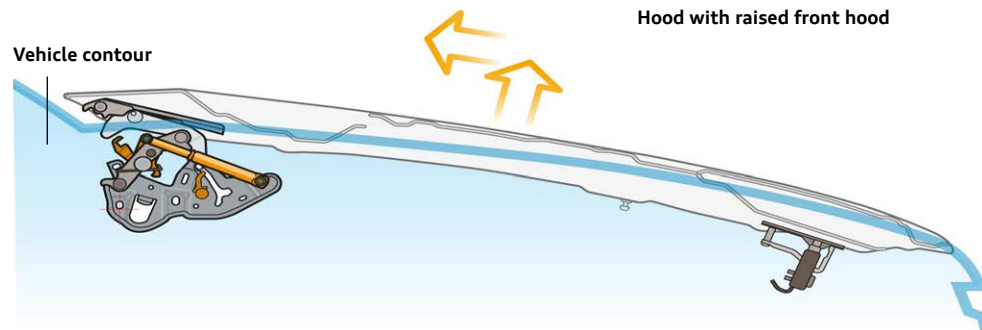

Re-active hood

In order to guarantee optimum protection for pedestrians, a number of vehicle models made by Audi are equipped with a re-active hood. In the event of a collision with a pedestrian in the front or rear area, the re-active hood is raised by pretensioned gas-pressure struts and pyrotechnic fuels. This increases the distance between the hood and the engine/motor. The hood can absorb more of the impact energy in this position, and thereby reduces the severity of injuries caused by the engine/motor.



Sources, further information

- VDA: Accident Assistance & Rescue for vehicles with high-voltage systems and 48 volt systems
- DGUV: Instructions for lithium-ion battery firefighting in vehicle fires (FBFHB 024)

	<p>Do not damage the gas generators during rescue operations. The compressed gas in the pressure vessel and the pyrotechnic fuels can pose a potential danger to the first and second responders and the occupants.</p>
	<p>Marking on the rescue sheet as per ISO 17840: re-active hood</p>

10. Explanation of pictograms used

10. Explanation of pictograms used

Components/functions/actions that shall be considered during the rescue procedure are represented by dedicated pictograms.

The pictograms are used:

- to indicate the location of the respective components/functions in the vehicle, in conjunction with the rescue sheet illustration (for details, see ISO 17840-1 and ISO 17840-2)
- ▶ to communicate a specific function or danger, for use under the rescue sheet additional
- pages headings and ERG headings
- ▶ to communicate the recognition of propulsion type; and
- ▶ to indicate the extinguish measures.

Level of importance:

1 = Crucial information for the rescue operations, as applicable to the vehicle type/model;
and

2 = Optional information, to further assist the rescue procedures



Some pictograms may be modified to reflect the actual size and shape.
A combination of simple shapes can also be used.

Pictograms concerning recognition



Examples of propulsion type recognition

Reference: ISO 17840-4

Level of importance: 1

To be used in/on:

- Rescue sheet illustration
- ERG under heading 1.

Note: Examples of pictograms for gasoline and electric drives are shown. See ISO 17840-4 for principles and other drive pictograms.

10. Explanation of pictograms used

Pictograms concerning access to the components



Title/Meaning/Referent:
Bonnet; hood

Function/description:
 To identify the control that opens the compartment located outside the passenger area in the front of the vehicle. A frame may be used to separate the pictogram from the background as needed.

Level of importance: 2

- To be used in/on:
- Rescue sheet illustration
 - ERG under heading 3

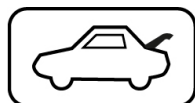

Boot; Trunk

To identify the control that opens the compartment located outside the passenger area in the rear of the vehicle. A frame may be used to separate the pictogram from the background as needed.

Level of importance: 2

- Rescue sheet illustration;
- Rescue sheet secondary pages under heading 3;
- ERG under heading 3

Pictograms concerning disabling of the vehicle (excluding high voltage)



Device to shut down power in vehicle

Shutdown power in vehicle, in all forms, by means of:

- Ignition key;
- Push button;
- Operation in engine compartment;
- Operation on dashboard;
- Battery switch;
- Other

Level of importance: 1

- Rescue sheet illustration;
- Rescue sheet secondary pages under heading 3;
- ERG under heading 3

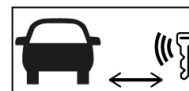

Remove smart key /starter key

To indicate that the smart key should be removed from the vehicle to prevent accidental starting of the vehicle. A safe distance may optionally be indicated.

Level of importance: 1

- Rescue sheet illustration;
- - Rescue sheet secondary pages under heading 3
- - ERG under heading 3



Air intake

To identify the air intake where CO₂ can be blown to stop the engine.

Level of importance: 1

- Rescue sheet illustration;
- Rescue sheet secondary pages under heading 3
- ERG under heading 3

10. Explanation of pictograms used

Pictograms concerning disabling of the vehicle high voltage (EV, HEV, PHEV, FCEV)

- Orange = High Voltage (Class B Voltage)
- Yellow = Controlling the High Voltage by Low Voltage
- Orange frame = Procedure for disabling High Voltage vehicle



Dangerous voltage

To identify the air intake where CO2 can be blown to stop the engine.

Level of importance: 1

- Rescue sheet illustration;
- Rescue sheet secondary pages under heading 3
- ERG under heading 3

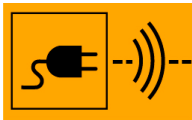

Vehicle induction charging

To indicate the vehicle is connected to an electromagnetic induction source for charging the high voltage traction batteries. To identify the location of the induction charging system or components.

Level of importance: 1

- Rescue sheet illustration;
- Rescue sheet secondary pages under heading 3
- ERG under heading 3

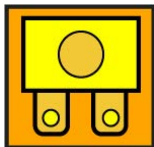

Fuse box disabling high voltage

To identify the low voltage fuse that controls the high voltage.

Level of importance: 1

- Rescue sheet illustration and secondary pages under heading 3.
- ERG under heading 3

Pictograms concerning disabling of the vehicle high voltage (EV, HEV, PHEV, FCEV)



Cable cut

To identify the cable to cut that disconnect high voltage and SRS components. To show that two separate places in the same cable shall be cut. Size and proportions can be adjusted to fit the intended purpose.

Level of importance: 1

- Rescue sheet illustration and additional pages under heading 3;
- ERG under heading 3



Disconnect high voltage device (e.g. service plug)

To identify the high voltage device that disconnects the high voltage, where appropriate PPE is needed for the action.

Level of importance: 1

- Rescue sheet illustration;
- Rescue sheet secondary pages under heading 3;
- ERG under heading 3

10. Explanation of pictograms used

Pictograms concerning disabling of the vehicle high voltage (EV, HEV, PHEV, FCEV)



Disconnect high voltage device

To identify the low voltage device that disconnects the high voltage

Level of importance: 1

- Rescue sheet illustration;
- Rescue sheet secondary pages under heading 3;
- ERG under heading 3

Pictograms concerning access to the occupants



Seat adjustment, longitudinal

To identify the control that moves the entire seat forward or rearward. A frame may be used to separate the pictogram from the background as needed.

Level of importance: 2

- ERG under heading 4



Lifting point; central support

To identify the locations on the equipment where a lifting jack or support device can be used.

Level of importance: 1

- Rescue sheet illustration;
- Rescue sheet secondary pages under heading 2;
- ERG under heading 2

Pictograms concerning access to the occupants



Steering wheel, tilt control

To identify the control that allows adjustment of the steering wheel by tilting up or down. A frame may be used to separate the pictogram from the background as needed.

Level of importance: 2

- ERG under heading 4



Seat height adjustment

To identify the control that moves the entire seat upward or downward. A frame may be used to separate the pictogram from the background as needed.

Level of importance: 2

- ERG under heading 4

10. Explanation of pictograms used

Other vehicle related pictograms

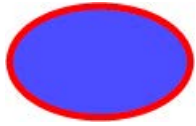

Airbag

To identify an airbag.

Level of importance: 1

- Rescue sheet illustration;
- ERG under heading 9

Pictogram can be adjusted to represent the actual size and form.

Different types of airbag-related occupant protection systems can be shown using the airbag pictogram with an appropriate size and form, e.g.:

- Driver / front passenger airbag
- Side airbag
- Curtain airbag
- Knee airbag
- Belt airbag
- Center airbag



Airbag inflator/stored gas inflator

To identify an airbag inflator/stored gas inflator.

Level of importance: 1

- Rescue sheet illustration;
- ERG under heading 9

Pictogram is used to show the location of the stored gas inflator for e.g. inflatable curtains or pedestrian protection active system.

This pictogram should not be shown for conventional airbag systems with integrated gas inflator, such as frontal airbag in the steering wheel or in the dashboard, side airbag, knee airbag.

Other vehicle related pictograms

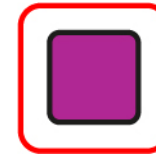

Seat belt pretensioner

To identify a seat belt pretensioner.

Level of importance: 1

- Rescue sheet illustration;
- ERG under heading 9

If a seating position has more than one pretensioner (e.g. for lap and shoulder belt), each pretensioner location shall be indicated by pictogram.

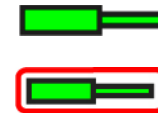

Gas strut, preloaded spring

To identify a gas strut, preloaded spring.

Level of importance: 1

- Rescue sheet illustration;
- ERG under heading 9

Red surrounding is used only if the device is triggered.



Pedestrian protection active system

To identify the pedestrian protection active system.

Level of importance: 1

- Rescue sheet illustration;
- ERG under heading 9



High strength zone

To identify a high strength zone.

Level of importance: 1

- Rescue sheet illustration;
- ERG under heading 9

10. Explanation of pictograms used

Other vehicle related pictograms

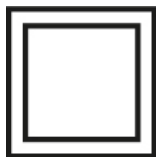

Zone requiring special attention

To identify the zone requiring special attention.

Level of importance: 1

- Rescue sheet illustration and secondary pages under heading 5;
- ERG under heading 5



Carbon structure

To indicate that carbon is used in the chassis structure. To inform about risks of inhalation, appropriate PPE is needed.

Level of importance: 1

- Rescue sheet illustration and secondary pages under heading 5;
- ERG under heading 5

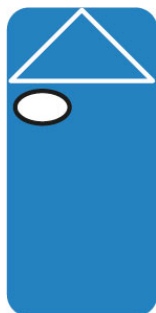

Left hand drive

To identify a left-hand drive vehicle.

Level of importance: 1

- Rescue sheet illustration

For use in the header of the rescue sheet. The colour can be adjusted to contrast with the background of the header.

Other vehicle related pictograms



Right hand drive

To identify a left-hand drive vehicle.

Level of importance: 1

- Rescue sheet illustration

For use in the header of the rescue sheet. The colour can be adjusted to contrast with the background of the header.

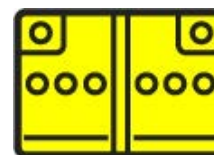

Battery, low-voltage

To identify a low voltage battery.

Level of importance: 1

- Rescue sheet illustration;
- Rescue sheet secondary pages under heading 5;
- ERG under heading 5.

For class A voltage application.

It shall be accompanied with the technology of the battery (e.g Li-Ion or Ni-MH) if different from a conventional battery type.



Ultra-capacitor, low-voltage

To identify a low voltage ultra-capacitor.

Level of importance: 1

- Rescue sheet illustration;
- Rescue sheet secondary pages under heading 5;
- ERG under heading 5

10. Explanation of pictograms used

Other vehicle related pictograms



Solar Panel

To identify a solar panel.

Level of importance: 1

- Rescue sheet illustration;
- Rescue sheet secondary pages;
- ERG under heading 3



SRS control unit

To identify a SRS control unit.

Level of importance: 1

- Rescue sheet illustration;
- ERG under heading 9



Battery pack, high-voltage

To indicate a high voltage battery pack.

Level of importance: 1

- Rescue sheet illustration;
- Rescue sheet secondary pages under heading 3;
- ERG under heading 3

Pictogram can be adjusted to represent the actual size and form.

It shall be accompanied with the technology of the battery (e.g. Li-Ion or Ni-MH).

Optionally, the nominal voltage value of the battery may be added.

Other vehicle related pictograms



High voltage ultra-capacitor

To indicate an ultra-capacitor pack.

Level of importance: 1

- Rescue sheet illustration;
- Rescue sheet secondary pages;
- ERG under heading 3



High voltage component

To indicate a high voltage component.

Level of importance: 1

- Rescue sheet illustration;
- Rescue sheet secondary pages;
- ERG under heading 3

Flash may be omitted in case of space constraints.



High voltage power cable

To identify a high voltage power cable.

Level of importance: 1

- Rescue sheet illustration;
- ERG under heading 3

It can optionally have a black contour line. HV components should be possible to differentiate from HV battery pack.

Legend and pictogram graphics should correspond with regard to the use of contour line concept.

10. Explanation of pictograms used

Other vehicle related pictograms



Fuel tank content Diesel

To indicate the content of the tank by using a defined colour.

Level of importance: 1

- Rescue sheet illustration;
- Rescue sheet secondary pages under heading 5;
- ERG under heading 5



Fuel tank content gasoline/ethanol

To indicate the content of the tank by using a defined colour.

Level of importance: 1

- Rescue sheet illustration;
- Rescue sheet secondary pages under heading 5;
- ERG under heading 5



Air tank

To indicate an air tank.

Level of importance: 1

- Rescue sheet illustration;
- ERG under heading 5

Other vehicle related pictograms



Air-conditioning component

To indicate an air conditioning component by using a defined colour.

Type of coolant shall be mentioned in additional pages and rescue sheet (e.g. CO₂, fluor-carbon based chemistry).

Level of importance: 1

- Rescue sheet illustration;
- Rescue sheet secondary pages under heading 5;
- ERG under heading 5

Snow flake may be omitted in case of space constraints.

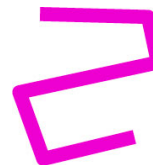

Air-conditioning line

To indicate an air-conditioning line by using a defined colour.

Type of coolant or name shall be mentioned (e.g. CO₂, fluor-carbon based chemistry).

Level of importance: 1

- Rescue sheet illustration;
- ERG under heading 5

10. Explanation of pictograms used

Pictograms related to fire fighting and safety



General warning sign

To signify a general warning.

Level of importance: 1

- Rescue sheet secondary pages under heading where necessary;
- ERG under heading where necessary



Warning, Electricity

To warn of electricity and dangerous voltage.

Level of importance: 1

- Rescue sheet secondary pages under heading where necessary;
- ERG under heading where necessary



Warning; low temperature

To indicate the dangers concerning low temperatures, e.g. frost bites due to cold gas (e.g. LNG, airconditioning gas)

Level of importance: 1

- Rescue sheet secondary pages under headings 5, 6, 8;
- ERG under headings 5, 6, 8, 9

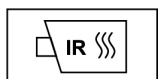

Use thermal Infrared camera

To indicate that a thermal infrared camera should be used to detect a fire.

Level of importance: 2

- Rescue sheet secondary pages under heading 6;
- ERG under heading 6

Pictograms related to fire fighting and safety



Automatic fire suppression system

To indicate an automatic fire suppression system in the vehicle.

Level of importance: 1

- Rescue sheet illustration;
- Rescue sheet secondary pages under heading 6;
- ERG under heading 6



Special battery access

Special access to put water in the HV battery of an EV vehicle.

Level of importance: 1

- Rescue sheet illustration;
- Rescue sheet secondary pages under heading 6;
- ERG under heading 6



Use water to extinguish the fire

To indicate that water shall be used to extinguish the fire.

Level of importance: 1

- Rescue sheet illustration;
- ERG under heading 6

10. Explanation of pictograms used

Pictograms related to fire fighting and safety



Use wet foam to extinguish the fire

To indicate that wet foam shall be used to extinguish the fire.

System in which a foam concentrate and air are continuously added under pressure to the water being discharged from a fire-fighting pump (CAFS).

Wet foam operation is defined by a nominal foam solution/air volume ratio between 1:3 and 1:10, being mixed in the CAFS.

Level of importance: 1

- Rescue sheet illustration;
- ERG under heading 6



Use dry foam to extinguish the fire

To indicate that dry foam shall be used to extinguish the fire.

System in which a foam concentrate and air are continuously added under pressure to the water being discharged from a fire-fighting pump (CAFS).

Dry foam operation is defined by a nominal foam solution/air volume ratio greater than 1:10, being mixed in the CAFS.

Level of importance: 1

- Rescue sheet illustration;
- ERG under heading 6

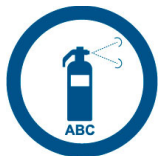

Use ABC powder to extinguish the fire

To indicate that ABC powder shall be used to extinguish the fire.

Level of importance: 1

- Rescue sheet illustration;
- ERG under heading 6

Pictograms related to fire fighting and safety



Do not extinguish with water

To prohibit using water to extinguish a fire.

Level of importance: 1

- Rescue sheet secondary pages under heading 6;
- ERG under heading 6

Globally harmonized symbols



Explosive

To indicate the risk of an explosion.

Level of importance: 1

- Rescue sheet secondary pages under headings 5, 6, 8, 9;
- ERG under headings 5, 6, 8, 9



Flammable

To indicate the risk of flammability.

Level of importance: 1

- Rescue sheet secondary pages under headings 5, 6, 8, 9;
- ERG under headings 5, 6, 8, 9

10. Explanation of pictograms used

Globally harmonized symbols



Gases under pressure

To indicate the risk of gases under pressure.

Level of importance: 1

- Rescue sheet secondary pages under headings 5, 6, 8, 9;
- ERG under headings 5, 6, 8, 9



Oxidizer

To indicate the risk of oxidizing material/substances.

Level of importance: 1

- Rescue sheet secondary pages under headings 5, 6, 8, 9;
- ERG under headings 5, 6, 8, 9



Corrosives

To indicate the risk of corrosive material/substances.

Level of importance: 1

- Rescue sheet secondary pages under headings 5, 6, 8, 9;
- ERG under headings 5, 6, 8, 9



Hazardous to the human health

To indicate the risk of damaging human health.

Level of importance: 1

- Rescue sheet secondary pages under headings 5, 6, 8, 9;
- ERG under headings 5, 6, 8, 9

Globally harmonized symbols



Acute toxicity

To indicate the risk of acute toxicity.

Level of importance: 1

- Rescue sheet secondary pages under headings 5, 6, 8, 9;
- ERG under headings 5, 6, 8, 9



Environmental hazard

To indicate the risk of environmental hazard.

Level of importance: 1

- Rescue sheet secondary pages under headings 5, 6, 8, 9;
- ERG under headings 5, 6, 8, 9

Symbols used in these guidelines



Note

General information