

INFORMATION FOR FIRST AND SECOND RESPONDERS
EMERGENCY RESPONSE GUIDE

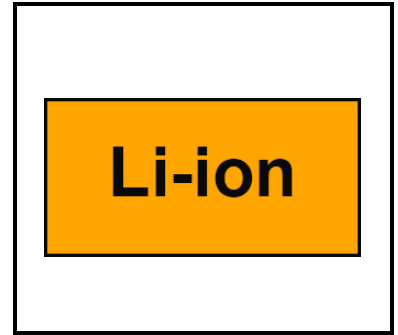

Cadillac LYRIQ
Passenger Car / Crossover
Li-ion Battery









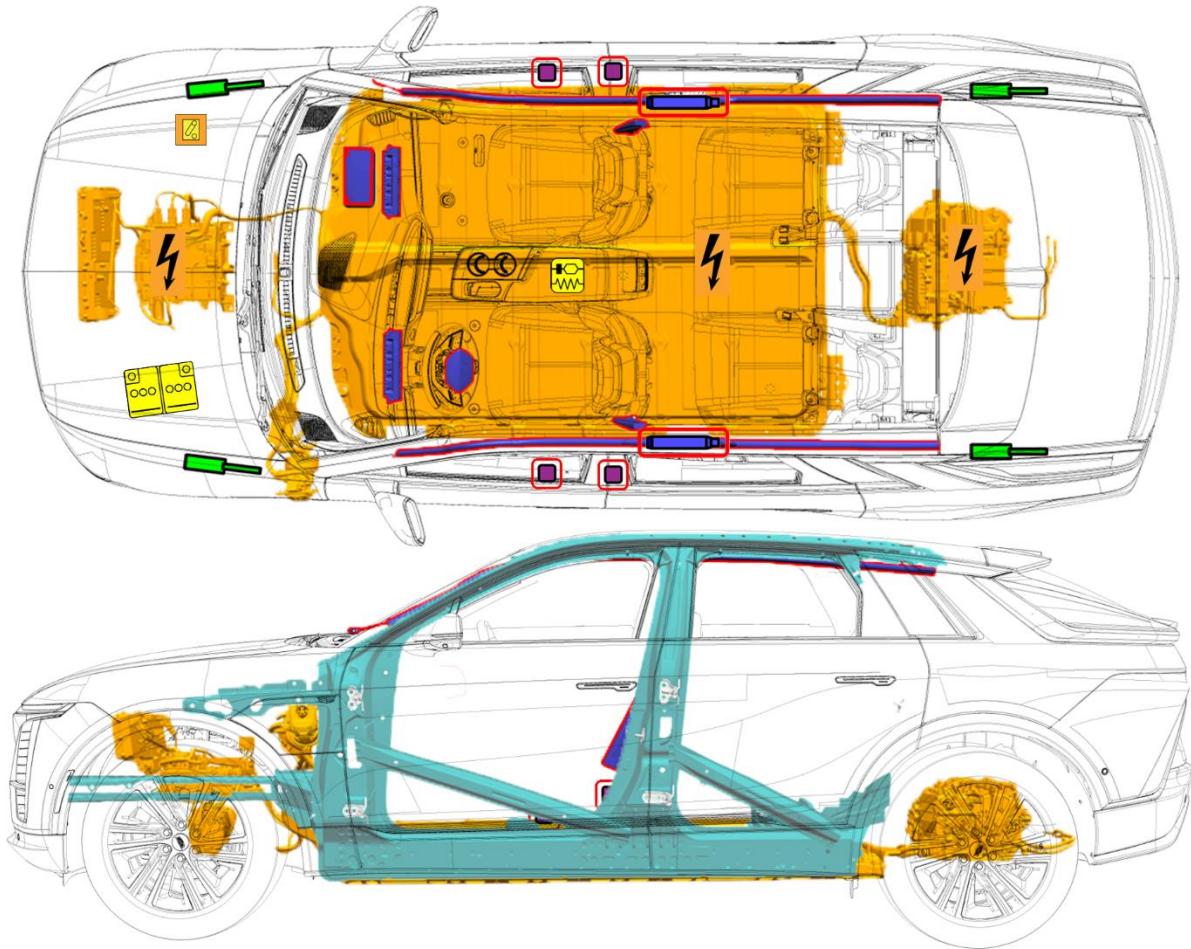











CONTENTS

0. Rescue Sheet	Page	3
1. Identification / recognition	Page	4
2. Immobilization / stabilization / lifting	Page	5
3. Disable direct hazards / safety regulations	Page	6
4. Access to the occupants	Page	8
5. Stored energy / liquids / gases / solids	Page	9
6. In case of fire	Page	10
7. In case of submersion	Page	11
8. Towing / transportation / storage	Page	11
9. Important additional information	Page	12
10. Explanation of pictograms used	Page	12

0. Rescue Sheet



	Airbag		Stored gas inflator		Seat belt pretensioner		SRS control unit		Pedestrian protection active system
	Automatic rollover protection system		Gas strut/Preloaded spring		High strength zone		Zone requiring special attention		
	Battery low voltage		Ultra capacitor, low voltage		Fuel tank		Gas tank		Safety valve
	High voltage battery pack		High voltage power cable component		High voltage disconnect		Fuse box disabling high voltage system		Ultra capacitor, high voltage

1. Identification / recognition



Advise Dispatch and all responders that an electric vehicle is involved.



Lack of engine noise does not mean vehicle is off: vehicle movement capability exists until vehicle is fully shut down. Always wear appropriate PPE.

Emblems and Badging

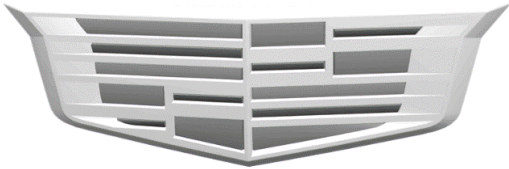

The Cadillac Crest appears on the hood, fenders, and rear liftgate.



The LYRIQ emblem is on the left side of the liftgate.



A numeric torque rating along with an “E” on the right side of the liftgate, indicates that the vehicle is Rear Wheel Drive (RWD).



A numeric torque rating along with an “E4” on the right side of the liftgate, indicates that the vehicle is All Wheel Drive (AWD).



High Voltage Battery Information

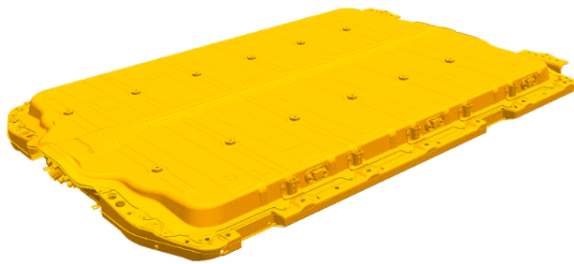

The battery is a High Voltage (Class B) Li-ion pack, that is a mounted under the vehicle and is a structural part of the floor pan.



Battery Warning Label



The battery warning label is located on the front compartment sight shield on the left side of the vehicle.

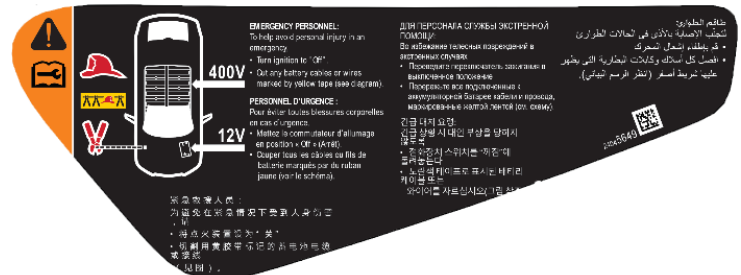

2. Immobilization / stabilization / lifting



IMMOBILIZE VEHICLE

- Block the wheels.
- Follow procedures for conventional vehicles.

Electric Parking Brake (EPB)

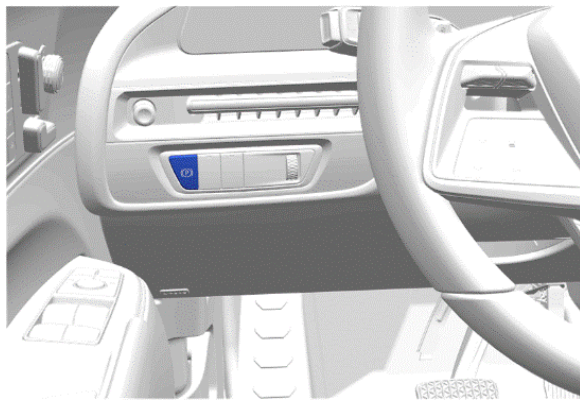

Applying the Electric Parking Brake

Press the EPB switch momentarily. The red parking brake status light will flash and then stay on once the EPB is fully applied.

Releasing the Electric Parking Brake

1. Turn the ignition on or to ACC/ACCESSORY.
2. Apply and hold the brake pedal.
3. Press the EPB switch momentarily.

The EPB is released when the red parking brake status light is off.

Electric Drive Unit Shift Lever

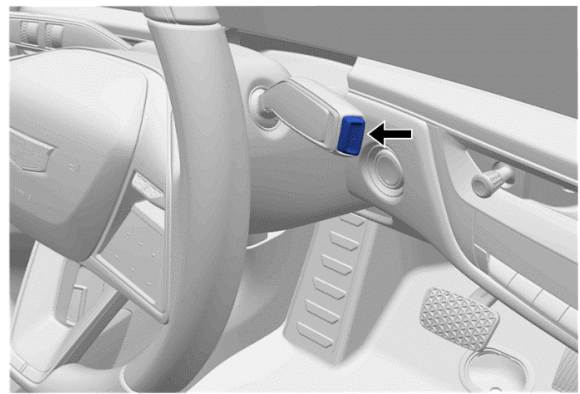

Shifting into Park

Press the button at the end of the shift lever to shift to P (Park).

Power Button

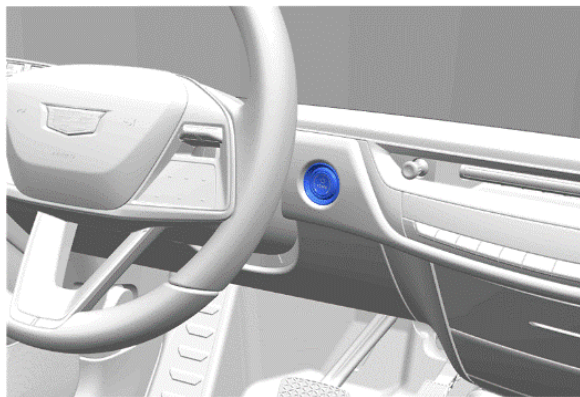

To turn the vehicle off, press the button on top of the shift lever to shift to P (Park) and press the POWER button.

Alternatively, press and hold the POWER button. The electric drive unit will shift to P (Park) then shut off automatically.



Lifting Points

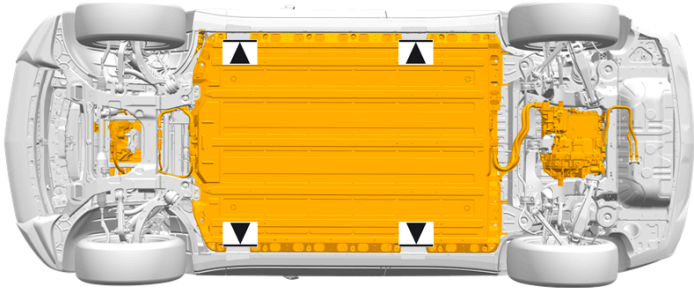

There are features on the body of the vehicle, for use as primary lifting points.

Do NOT lift the vehicle from any locations on the high voltage battery.

3. Disable direct hazards / safety regulations

Thermal Runaway Mitigation



The vehicle is equipped with a battery management system with internal fault detection, including thermal runaway mitigation. In the event of a “**Battery Danger Detected**” notification, **DO NOT cut or disable the 12-volt system, unless you need to disable the airbags for occupant extrication.**

Automatic safety systems are enabled when 12-volt power is available, including a battery thermal runaway mitigation system that internally cools the High Voltage battery when a thermal event is detected; this feature is available in non-crashed, static situations.

When these safeguards are activated, OnStar Advisors will contact First Responders. Information about this feature will be displayed on the driver instrument panel including a “Battery Danger Detected” message. The vehicle will also activate the horn and the hazard lights.

In the event of a “Battery Danger Detected” notification, DO NOT cut or disable the 12-volt system during the thermal runaway mitigation cycle, unless you need to disable the airbags for an occupant extrication.

Power Button

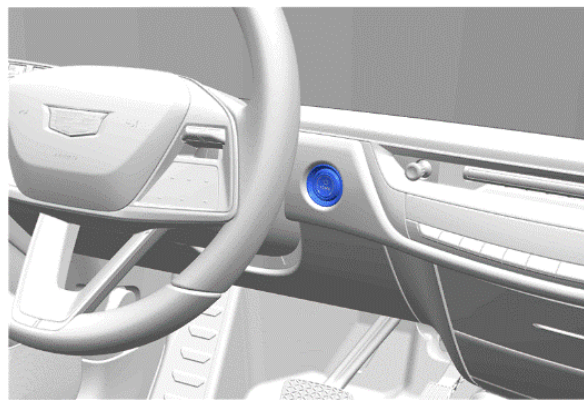

If the vehicle is already in PARK state, press the POWER button to disable vehicle propulsion.

Alternatively, press and hold the POWER button. The electric drive unit will shift to P (Park) then shut off automatically.



The high voltage system can remain energized even when the vehicle is in the OFF state.



Hood Release

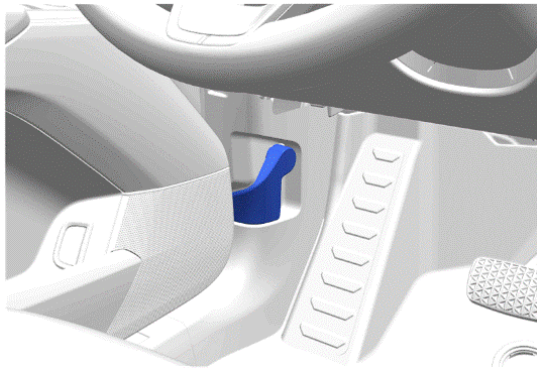

1. Pull the hood release handle on the lower left side of the instrument panel.
2. Release the handle, then pull the handle again to fully open the hood.
3. Go to the front of the vehicle and lift the hood open.



Low Voltage Cable Access

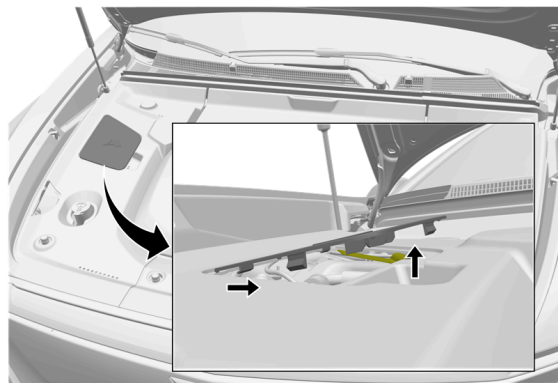

Remove the low voltage cable access cover:

1. Lift the inboard edge of the cover up to release the tabs.
2. Rotate the cover up and inboard to release the outboard tabs.

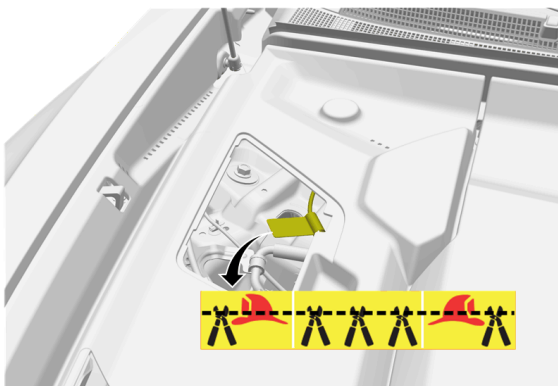

Low Voltage Cable

Double cut the low voltage cables on both sides of the yellow tape and remove the cut section of cable from the vehicle. Ensure that the cuts are clean and that there is no risk of loose wires touching. This cut will disable the airbags and high voltage.

DO NOT CUT ANY ORANGE COLORED HIGH VOLTAGE CABLES.



After disabling 12-volt power, wait at least 10 seconds to allow any un-deployed airbag reserve energy to dissipate and wait at least 1 minute to allow high voltage energy to discharge.

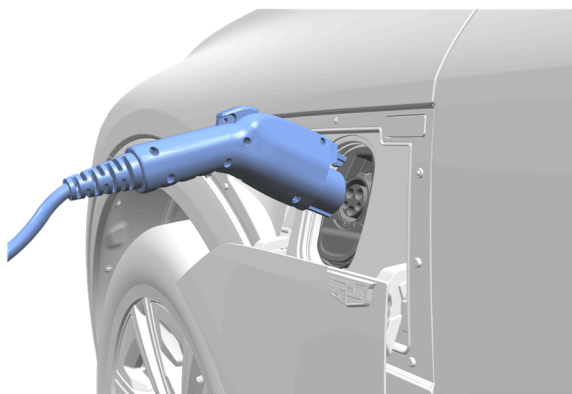

VEHICLE AT CHARGE STATION:

If able, terminate charging by removing the charge handle from the vehicle. If enabled, the vehicle's anti-theft alarm may activate.

The common charge handle is shown; The DC Fast Charge handle is moderately larger and may require additional effort to disconnect.

4. Access to the occupants

Refer to the vehicle *Rescue Sheet* for additional illustrations that show the locations of High Strength Structural Components, High Voltage Components, and Safety Components.

Vehicle Glass

 The windshield, sunroof, and front door windows are made of Laminated Glass

 The rear door windows, rear quarter and rear window are made of Tempered Glass

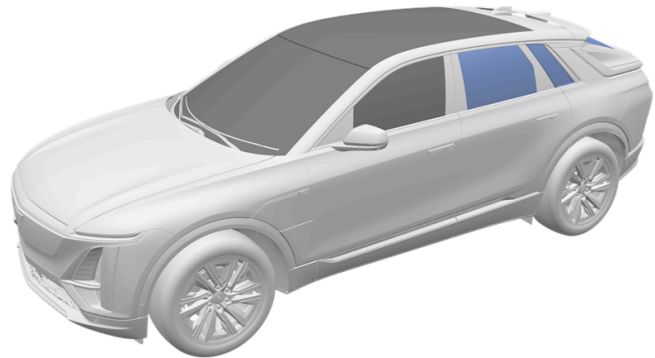

Opening a Locked Door



If the doors remain locked, pull **twice** on the inside door handle to gain access to the occupant at each seating location.

NOTE: An alternative method for rear passenger access may be necessary if the rear door child safety locks are engaged.

Steering Column Tilt and Telescoping Control Switch

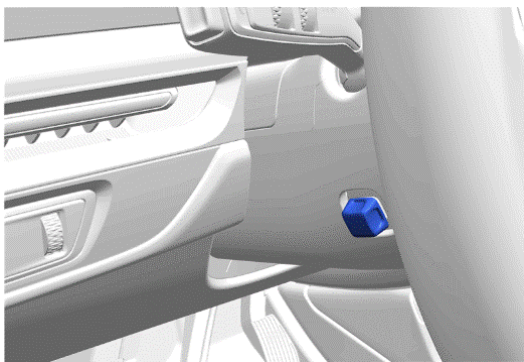

- Press the control up or down to tilt the steering wheel up or down.
- Press the control rearward or forward to move the steering wheel closer or away from you.

Seat Control Switches



The seat switches function the same for the driver and front seat passenger.

Top Switch

Rotate the switch forward to raise the seatback and rearward to recline the seatback.

Lower Switch

- Move the seat forward or rearward by sliding the control forward or rearward.
- Raise or lower the seat by moving the control up or down.

Occupant Restraint Systems

The LYRIQ is equipped with eight airbags:

- Driver (Steering Wheel)
- Front Seat Passenger (Instrument Panel)
- (2) Front Knee Bolster Airbags
- (2) Front Seat Outboard Airbags
- (2) Roof Rail Airbags

There are seat belt restraints for five occupants.

The front seat belt system includes two pretensioners on each side. One is seat belt retractor mounted and the other is mounted to the seat belt anchor at the base of the seat.

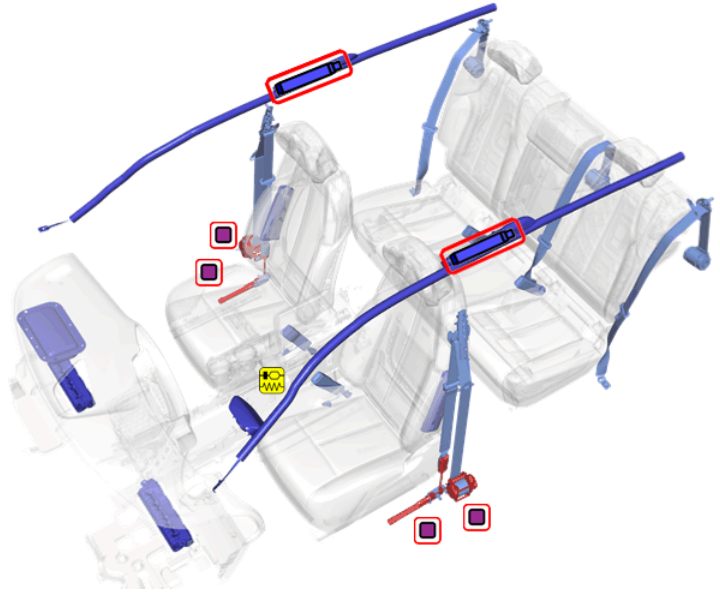

High Strength Steel Structure

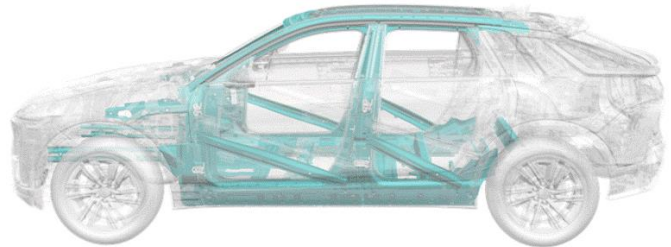
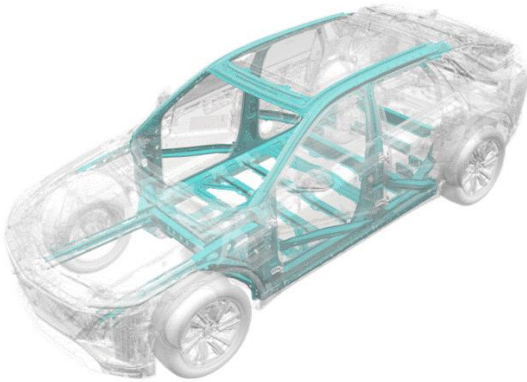

The passenger compartment is protected using high strength steel in the pillars, rocker panels, door reinforcement beams, and floor structure.



As with any occupant extrication, exercise caution. The vehicle's high voltage cables and components may be energized with high voltage. Avoid touching or cutting high voltage cables or components during any rescue operation.





5. Stored energy / liquids / gases / solids









Li-ion

High Voltage Lithium-Ion Chemistry Battery



High Voltage Warning, potential for electric shock

	Gases emitted from the battery pack are flammable
	Gases emitted from the battery pack are toxic
	Skin contact may cause irritation. Prolonged contact with electrolyte mixture may result in more severe irritation. Flush contaminated skin with plenty of water.
 	Coolant leaking inside the battery pack can become unstable and possibly a risk for a fire. Check the battery pack temperature using a thermal imaging camera.

6. In case of fire	
	High Voltage Warning, potential for electric shock
	A battery on fire will not explode
	A battery on fire will not explode. If battery cells reach high enough temperature, they vent and release electrolyte. Battery electrolyte is flammable.
	Gases emitted from the battery pack are toxic
	Skin contact may cause irritation. Prolonged contact with electrolyte mixture may result in more severe irritation. Flush contaminated skin with plenty of water.
	Potential for eye, nose, and throat irritation with prolonged exposure.
	Use copious amounts of water to cool the battery and to extinguish a fire. Do NOT use an ABC dry chemical extinguisher because it will not extinguish a battery fire.
 	Potential for Battery Re-Ignition.

7. In case of submersion

The high voltage battery is isolated from the vehicle chassis. If the vehicle is immersed in water, there is no risk of electrocution by touching the vehicle.

After the vehicle was removed from the water, do the following:

1. Allow the vehicle to dry out.
2. Perform the high voltage disabling procedure in Section 3.

8. Towing / transportation / storage

Tow Hooks

Carefully open the cover in the fascia by using the small notch that conceals the tow eye socket.

Install the tow eye into the socket and turn it until it is fully tightened. When the tow eye is removed, reinstall the cover with the notch in the original position.

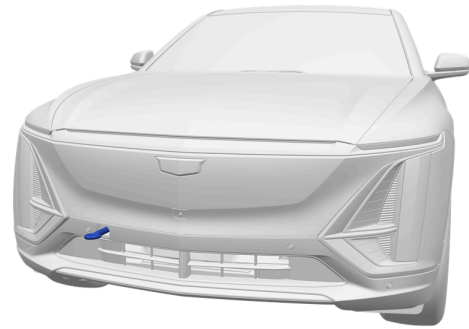

Vehicle Towing and Transportation

GM recommends a flatbed carrier to transport a disabled vehicle.

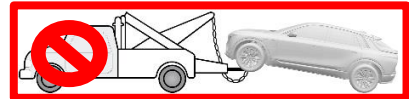
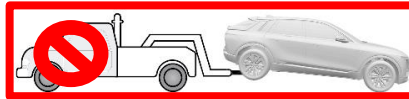
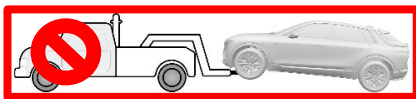
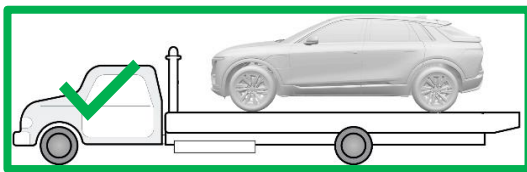

Post-Crash Vehicle Storage

Store the vehicle a safe distance (15 meters / 50 feet) or separated from other vehicles.



Potential for continued hazards (rekindling/re-gassing/etc) if a damaged vehicle battery is jostled during recovery, including the towing and storage process.

















After a "Battery Danger Detected" notification, or thermal runaway mitigation cycle completes, it might be appropriate to wait up to an hour before towing to a certified dealer for vehicle inspection even though evidence of a thermal event such as smoke may not be visible, and unusual odors may not be detected from the vehicle.

9. Important additional information

This vehicle is supported by OnStar, where available.

10. Explanation of pictograms used

	Electric Vehicle		General warning sign		Warning, Electricity
	Battery Technology		Lifting Points		Thermal Imaging Camera
	Flammable		Toxic		Corrosive
	Injury Risk		Use Water		Front Compartment Release
	Power Button		Cable Cut Location		