



2022 LEAF

First Responder's Guide



zero Emission

Foreword

This manual describes first response operations and **important safety** related warnings for this vehicle.

This vehicle is an electrically driven car equipped with a high-voltage battery pack. **Failure to follow recommended practices during emergency responses will cause death or serious personal injury.**

Please read this manual in advance in order to understand the features of this vehicle and to help you deal with incidents involving this vehicle. Follow the procedures in order to help assure a safe and successful first response operation.

This manual is periodically updated. If you are not viewing this manual on the Nissan web site, we urge you to go to www.nissanusa.com or www.nissan-techinfo.com to make sure you have the most recent version of this manual.

NISSAN EMERGENCY CONTACT INFORMATION

- Nissan EV Customer Support: 1-877-664-2738
- Nissan Consumer Affairs: 1-800-647-7261 (US) or 1-800-387-0122 (Canada)

IMPORTANT INFORMATION ABOUT THIS MANUAL

You may see various symbols in this manual. They have the following meanings:



This symbol is used to inform you of an operation which will result in death or serious personal injury if instructions are not followed.

Example: Touching high-voltage components without using the appropriate protective equipment will result in electrocution.



This symbol is used to inform you of an operation which may cause death or serious personal injury if instructions are not followed.



This symbol is used to inform you of an operation which may cause personal injury or component damage if instructions are not followed.

Please note that there may be differences between this manual and the vehicle specification due to specification changes.

Table of Contents

FOREWORD	FRG-2
NISSAN EMERGENCY CONTACT INFORMATION	FRG-2
IMPORTANT INFORMATION ABOUT THIS MANUAL	FRG-2
1. ABOUT THE NISSAN LEAF®	FRG-4
1-1 LEAF IDENTIFICATION	FRG-5
1-1.1 EXTERIOR	FRG-5
1-1.2 INTERIOR COMPONENT LOCATION	FRG-6
1-2 VEHICLE IDENTIFICATION NUMBER (VIN) LAYOUT	FRG-7
1-3 WARNING AND INDICATOR LAMP INFORMATION	FRG-8
2. BASIC HIGH-VOLTAGE SYSTEM AND 12-VOLT SYSTEM INFORMATION	FRG-9
2-1 HIGH-VOLTAGE-RELATED AND 12-VOLT-RELATED COMPONENT LOCATIONS AND DESCRIPTIONS	FRG-9
2-1.1 HIGH-VOLTAGE BATTERY PACK SPECIFICATIONS	FRG-11
2-2 HIGH-VOLTAGE SAFETY MEASURES	FRG-11
2-2.1 WARNING LABELS	FRG-11
2-3 HIGH-VOLTAGE CIRCUIT SHUT-OFF SYSTEM	FRG-13
2-4 PREVENTING ELECTRICAL SHOCK	FRG-13
2-5 EMERGENCY MEDICAL EQUIPMENT	FRG-13
3. EMERGENCY RESPONSE STEPS	FRG-14
3-1 PREPARATION ITEMS	FRG-15
3-1.1 PERSONAL PROTECTIVE EQUIPMENT (PPE) PROTECTIVE WEAR CONTROL	FRG-16
3-1.2 DAILY INSPECTION	FRG-16
3-1.3 INSULATED TOOLS	FRG-16
3-2 VEHICLE IMMOBILIZATION AND STABILIZATION	FRG-17
3-3 HOW TO HANDLE A DAMAGED VEHICLE AT AN ACCIDENT SCENE	FRG-18
3-3.1 HIGH-VOLTAGE SYSTEM SHUT-DOWN PROCEDURES	FRG-19
3-3.2 WATER SUBMERSION	FRG-29
3-3.3 VEHICLE FIRE	FRG-29
3-3.4 CUTTING THE VEHICLE BODY	FRG-30
3-3.5 HIGH-VOLTAGE BATTERY DAMAGE AND FLUID LEAKS	FRG-35
3-3.6 ACCESSING THE OCCUPANTS	FRG-36
3-4 STORING THE VEHICLE	FRG-37
4. EMERGENCY QUICK REFERENCE GUIDE	FRG-38

1. About The Nissan LEAF®

This vehicle uses two types of batteries. One is a 12-volt battery that is the same as the battery in vehicles powered by internal combustion engines, and the other is the high-voltage battery for the traction motor which propels the vehicle. The high-voltage battery is encased in steel and mounted underneath the vehicle.

The vehicle must be plugged-in in order for the high-voltage battery to be recharged. Additionally, the vehicle system can recharge the high-voltage battery by converting driving force into electricity while the vehicle is decelerating or being driven downhill. This is called regenerative charging. This vehicle is considered to be an environmentally friendly vehicle because it does not emit exhaust gases.

1-1 LEAF Identification

1-1.1 Exterior

The specific exterior identification features are indicated as follows:

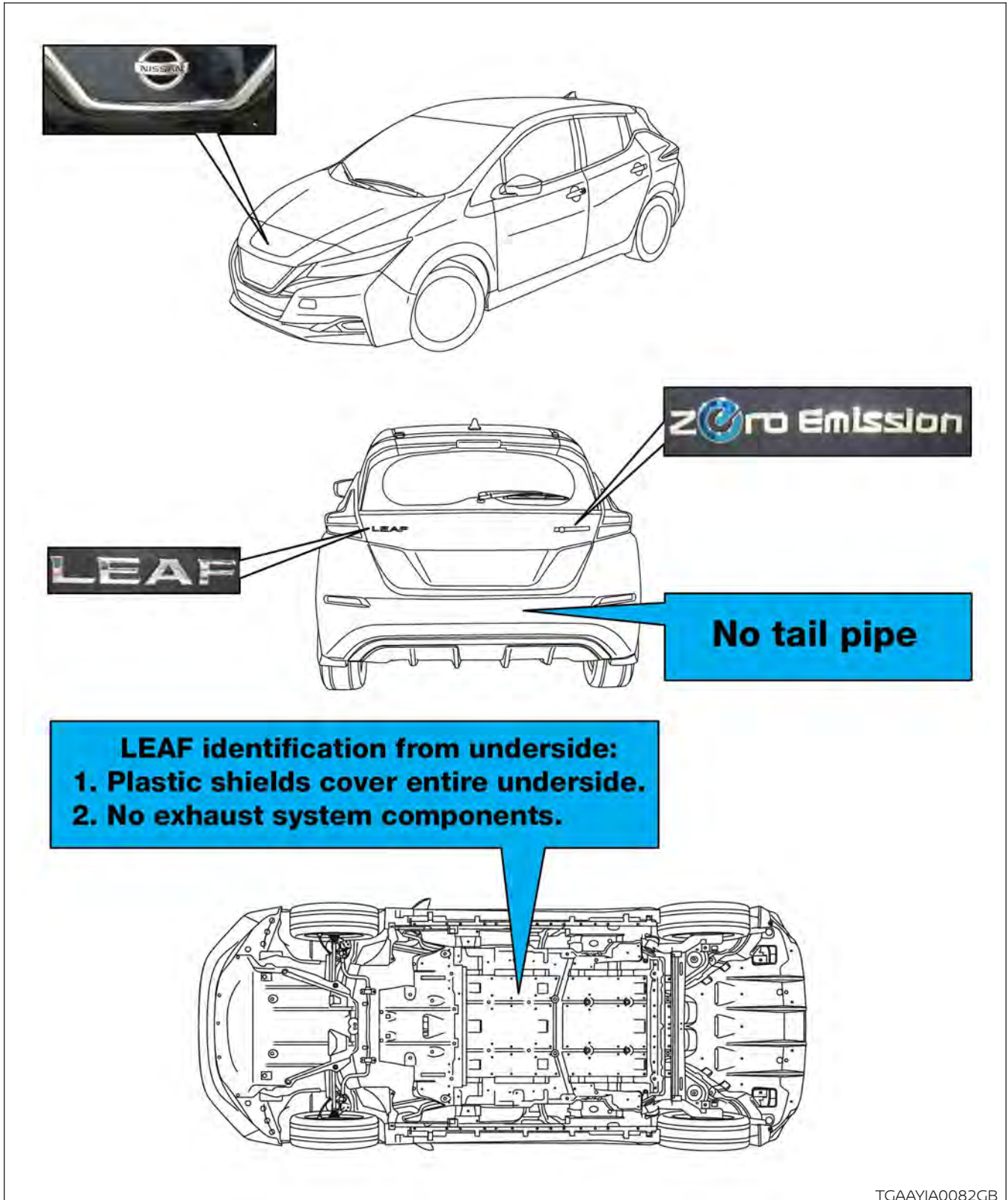

TGAAYIA0082GB

1-1.2 Interior Component Location

Interior components referenced in this manual are as follows:

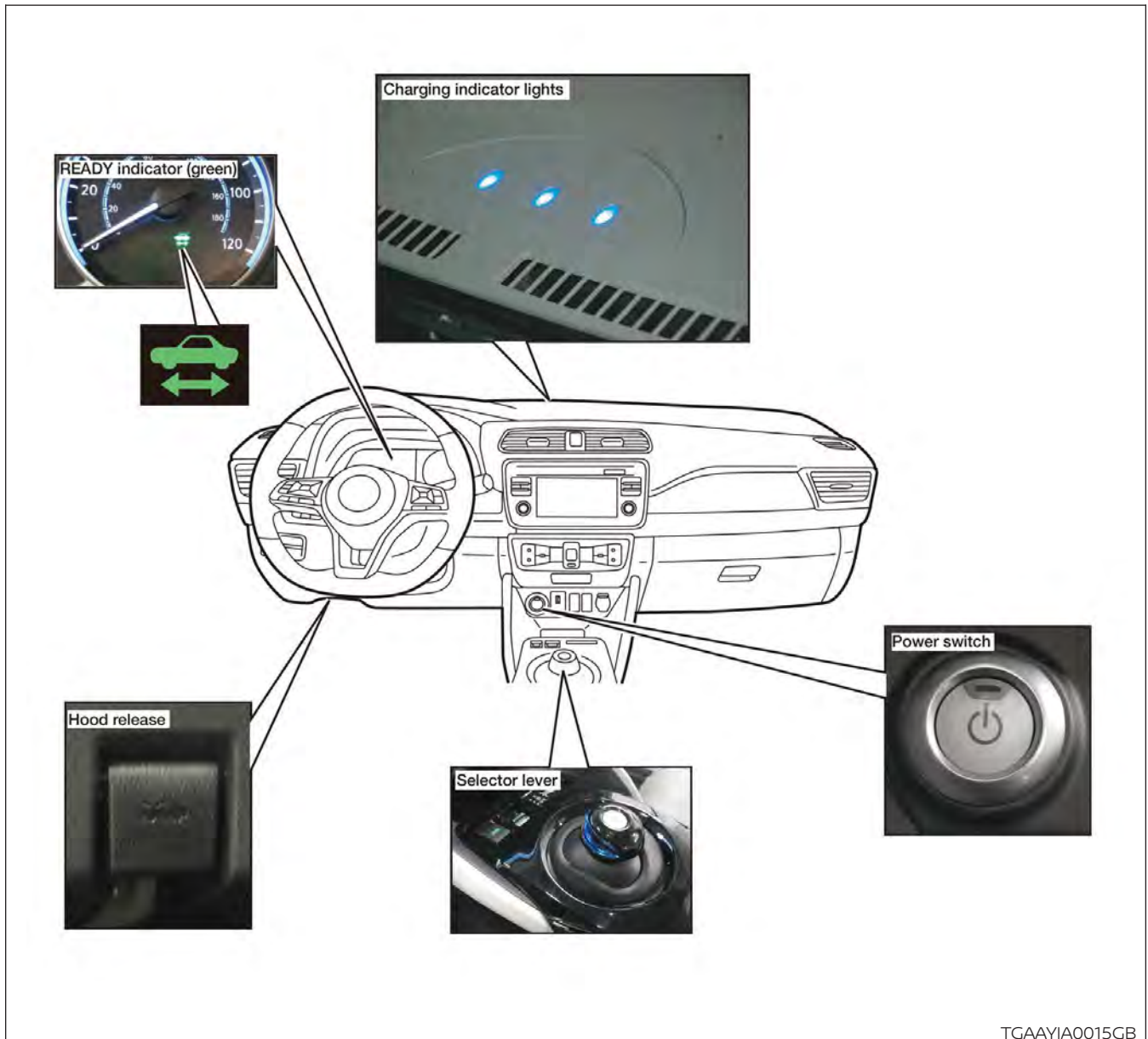

1-2 Vehicle Identification Number (VIN) Layout

The vehicle identification number can be located as follows: Example VIN :
1N4**A/BZ**1CPXNC053500

The High-voltage battery type is identified by the 4th alphanumeric character: **A** or **B**

A = 40 kWh Battery

B = 62 kWh Battery

The LEAF is identified by the 5th alphanumeric character: **Z**

Z = Electric vehicle

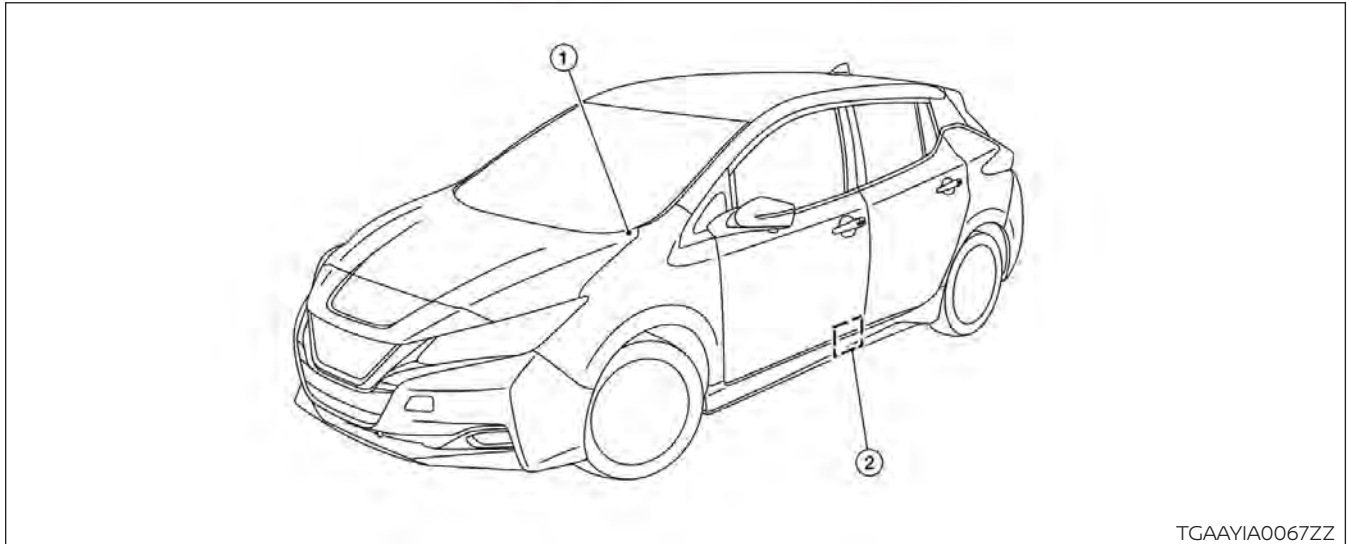





TGAAYIA0067ZZ

1. VIN plate (visible through windshield)

2. Vehicle certification label (lower center pillar)

1-3 Warning and Indicator Lamp Information

The following warning and indicator lamps are located in the instrument cluster.

Lamp Name	Icon	Description
READY Indicator		This lamp is on when the EV system is powered up and the vehicle is ready to drive.
EV System Warning Lamp*1		<ul style="list-style-type: none"> ▪ Malfunction has occurred in the EV system and/or ▪ Emergency shut-off system has been activated. The shut-off system activates in the following conditions: <ul style="list-style-type: none"> - Front and side collisions in which the air bags are deployed. - Certain rear collisions. - Certain EV system malfunctions.
Master Warning Lamp (RED)		This lamp is on when another red warning lamp is displayed in the instrument cluster or a warning is displayed on the vehicle information display.
Master Warning Lamp (YELLOW)		<p>This lamp is on when:</p> <ul style="list-style-type: none"> ▪ High-voltage battery is getting low on charge. ▪ A yellow warning lamp is displayed in the instrument cluster or a message is displayed on the vehicle information display.

*1: The READY indicator light will turn off in certain EV system malfunctions.

2. Basic High-Voltage System and 12-volt System Information

2-1 High-Voltage-Related and 12-volt-Related Component Locations and Descriptions

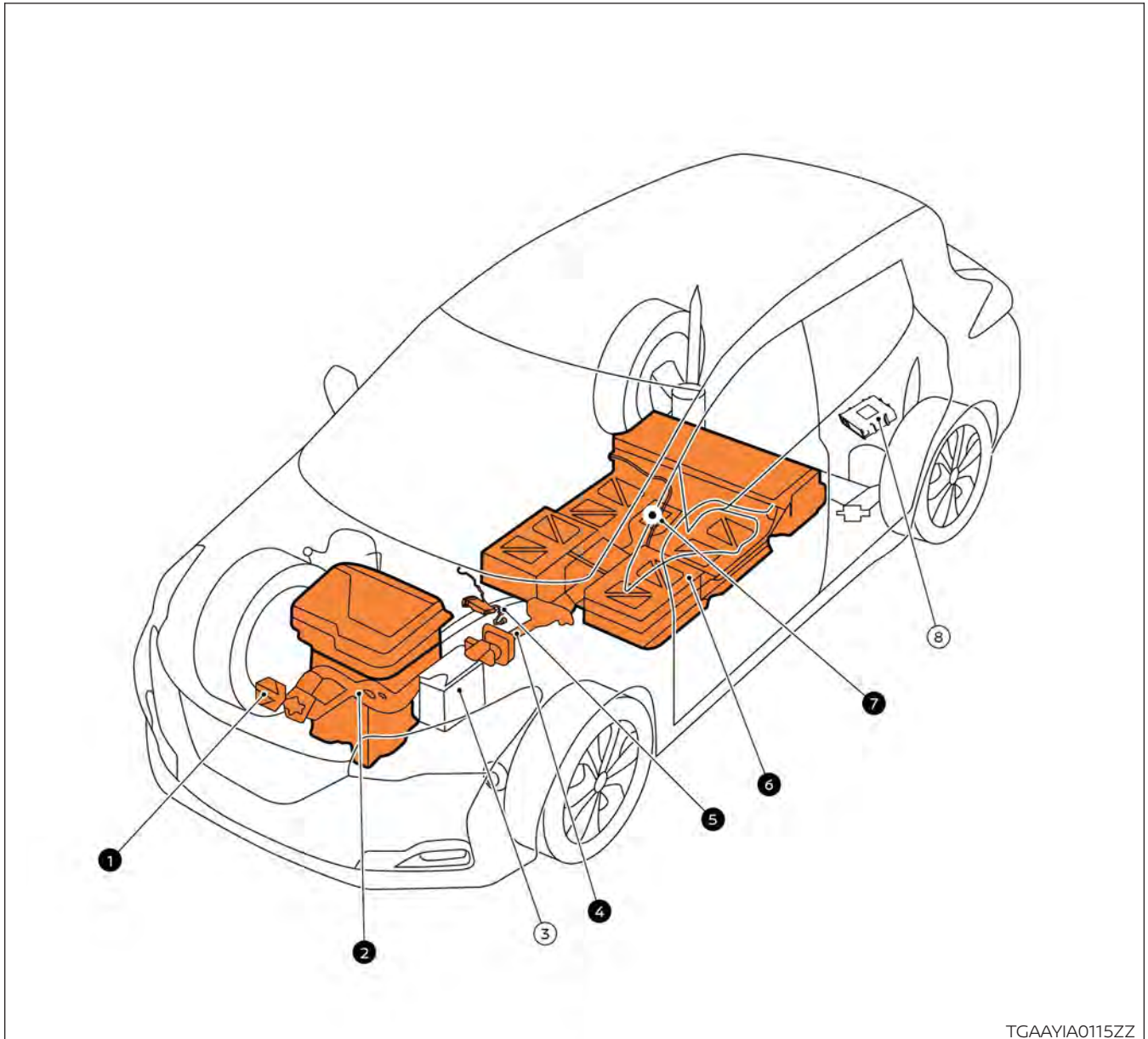

NOTE:

Components with white number in black background are high-voltage components.

No.	Component	Location	Description
①	Charge port	Under hood	Connecting port for EVSE (Electric Vehicle Supply Equipment). Two ports are available: Normal charge and quick charge (if so equipped).
②	Traction Motor	Under hood	Converts three-phase AC power to drive power (torque) which propels the vehicle.
	Inverter	Under hood	Converts the DC power stored in the high-voltage battery to three-phase AC power and controls motor torque (revolution) by regulating the motor current.
	Electric air conditioner compressor	Under hood	Air conditioner compressor
	Power Delivery Module (PDM) <ul style="list-style-type: none"> • On Board Charger • DC/DC Converter • High-voltage junction box (J/B) 	Under hood	The PDM includes an On Board Charger, DC/DC converter and high-voltage junction box (J/B). The On Board Charger converts single-phase AC power from a home power outlet to DC power and increases the voltage in order to charge the high-voltage battery. The DC/DC converter reduces the voltage of the high-voltage battery to provide power to the 12-volt battery in order to operate the vehicle's electric components (headlights, audio system, etc.). The J/B provides electric power from the high-voltage battery to all high-voltage parts of the vehicle.
③	12-volt Battery	Under hood	A lead-acid battery that supplies power to the low voltage devices.
④	High-voltage cables	Under hood and undercarriage	Orange-colored power cables carry high-voltage current between each of the high-voltage components.
⑤	Cabin heater	Interior (This unit is installed behind the instrument panel)	This is the electric heat source for the cabin heater. It heats the interior of the vehicle.
⑥	High-voltage battery	Undercarriage	Stores and outputs DC power (Maximum voltage 420V) needed to propel the vehicle.
⑦	High-voltage battery service disconnect	Rear seat floor	Isolates the battery from the rest of the high-voltage electrical system.
⑧	Brake power supply backup unit	Cargo area (This unit is installed behind a trim panel to prevent access)	Power supply backup unit for the brake system. It supplies power to the brake system if a malfunction occurs in the 12-volt battery.

2-1.1 High-Voltage Battery Pack Specifications

High-voltage battery voltage	(240V - 420V usable range)
Number of high-voltage battery modules in the pack	24
High-voltage battery dimensions	60.90 x 46.77 x 10.39 in. (1547 x 1188 x 264 mm)
High-voltage battery weight	668.1 lbs (303 kg)

2-2 High-Voltage Safety Measures

Circuit insulation	The high-voltage positive (+) and negative (-) circuits are insulated from the metal chassis.
Reducing the risk of electrocution	The high-voltage components and harnesses have insulated cases or orange-colored coverings which provide insulation and easy identification. The high-voltage battery case is electrically connected to the vehicle ground. This connection helps protect the vehicle occupants and emergency responders from high-voltage electrical shock.
Identification	The high-voltage components are labeled "WARNING" similar to the label shown below. All high-voltage harnesses are coated in orange.

2-2.1 Warning Labels

The following warning label is applied to the power delivery module (PDM) located under hood.

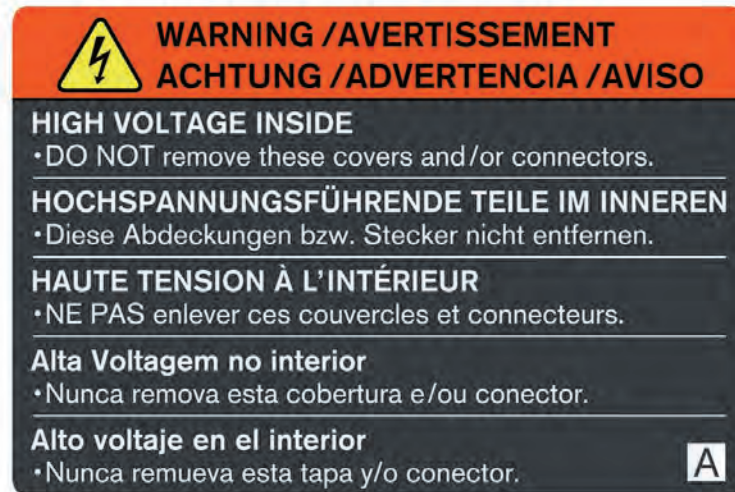

TGAAYIA0055ZZ

The following warning label is applied to the service plug access cover located in the rear seat floor.



AAYIA0455ZZ

The following warning label is applied to the high-voltage battery located on the vehicle's undercarriage.



AAYIA0456ZZ

2-3 High-Voltage Circuit Shut-Off System

The high-voltage can be shut off by the following methods:

Service plug	Positioned in the center area of the high-voltage battery, this shuts off output high-voltage when manually removed.
System main relay (located in high-voltage battery)	Controlled by the power switch, this relay, which is controlled by the 12-volt system, shuts off the high-voltage from the high-voltage battery.
Emergency shut-off system	In the case of a collision (front and side collisions in which the air bags are deployed, certain rear collisions) or certain system malfunctions this system is designed to shut off the high-voltage from the high-voltage battery.
Charging connector	Some of the high-voltage components are activated during charging. Remove the charging connector to deactivate these components.

2-4 Preventing Electrical Shock

1. If it is necessary to touch any of the high-voltage harnesses or components, you must always wear appropriate Personal Protective Equipment (PPE) (refer to [3-1 Preparation Items \(FRG-15\)](#)) and shut off the high-voltage system by referring to [3-3.1 High-voltage System Shut-Down Procedures \(FRG-19\)](#).
2. To avoid the risk of electrocution, NEVER touch the inside of the high-voltage battery unless appropriate PPE is worn even after shutting off the high-voltage system. The high-voltage battery maintains charge even though the high-voltage system is shut down.
3. Cover any damaged high-voltage components with insulated tape.

2-5 Emergency Medical Equipment

The high-voltage system should not interfere with emergency medical equipment which must be used in or near the vehicle at an accident scene.

3. Emergency Response Steps







DANGER

- Failure to properly shut down the high-voltage electrical system before the Emergency Response Procedures are performed will result in serious injury or death from electrical shock. To prevent serious injury or death, NEVER touch high-voltage harnesses or components without always wearing appropriate Personal Protective Equipment (PPE).
- If it is necessary to touch any of the high-voltage harnesses or components you must always wear appropriate PPE to avoid electrical shock. Shut down the high-voltage system by following the steps outlined in [3-3.1 High-voltage System Shut-Down Procedures \(FRG-19\)](#). Wait at least ten (10) minutes for complete discharge of the high-voltage capacitor after the high-voltage system has been shut down.

WARNING

- NEVER assume the LEAF is shut OFF simply because it is quiet.
- If the READY indicator or charging indicator are ON, the high-voltage system is active.
- If possible, be sure to verify that the READY indicator on the instrument cluster is OFF and the high-voltage system is stopped.
- Some of the under hood parts get hot and may cause serious burns. Use caution when working on or around these parts.

3-1 Preparation Items

Preparation Items	Specification	Purpose
Personal Protective Equipment (PPE): Insulated gloves 	Up to 1,000V	For protection from high-voltage electrical shock
Insulated shoes 	-	
Safety shield 	-	
Leather gloves 	Must be able to fasten tight around the wrist (worn over insulated gloves).	To protect insulated gloves
Wrenches 	Size: 10mm	To remove the service plug access cover bolts. To remove the 12-volt battery terminal bolt.
Solvent resistant protection gloves Solvent resistant protection shoes	- -	To utilize in the event of a high-voltage battery electrolytic solution leak.
Absorbent pad	The same pad used for internal combustion engine fluids can be used.	To absorb any high-voltage battery electrolytic solution leakage.
Standard fire fighting equipment	Standard fire fighting equipment Depending on type of fire (vehicle or battery) use standard fire fighting equipment (water or extinguisher).	To extinguish a fire.
Insulated tape	Insulating	To cover any damaged harnesses to protect from and prevent electrical shock. Tape should cover all bare or damaged wire.

3-1.1 Personal Protective Equipment (PPE) Protective Wear Control

Perform an inspection of the Personal Protective Equipment (PPE) items before beginning work. Do not use any damaged PPE items.

3-1.2 Daily Inspection

This inspection is performed before and after use. The responder who will be using the items should perform the inspection and check for deterioration and damage.

- Insulated rubber gloves should be inspected for scratches, holes and tears. (Visual check and air leakage test)
- Insulated safety boots should be inspected for holes, damage, nails, metal pieces, wear or other problems on the soles. (Visual check)
- Insulated rubber sheet should be inspected for tears. (Visual check)

3-1.3 Insulated Tools

When performing work at locations where high-voltage is applied (such as terminals), use insulated tools meeting 1,000V/300A specifications.

3-2 Vehicle Immobilization and Stabilization

If possible, immobilize the vehicle by turning the 12V system OFF and stabilize it with a wheel chock(s). Stabilize the vehicle with cribbing, by removing air from the tires, or utilize the Lift Airbag Equipment for rescue.

⚠ WARNING

- Do not stabilize the vehicle with cribbing under the high-voltage battery.
- To avoid electrical shock, do not put the Lift Airbag Equipment for rescue and wheel chock(s) under the high-voltage components and harnesses as shown following.

 =  **DANGER** High-voltage battery

 = Do Not Lift Zone

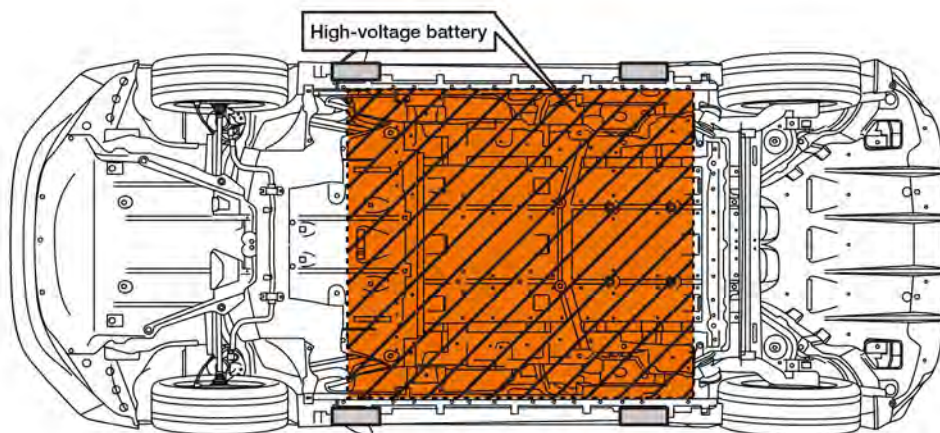
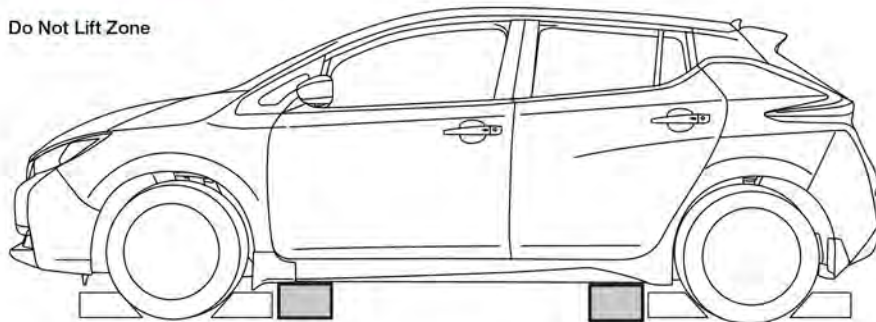

TGAAYIA0013CB

3-3 How to Handle a Damaged Vehicle at an Accident Scene

NOTE:

If any air bags have deployed in the following 3 situations, the high-voltage (HV) system has been designed to automatically shut off at the time of deployment.

The Nissan LEAF high-voltage system incorporates capacitors which are energized whenever the high-voltage system is on. If the high-voltage system is shut down (either through one of the built-in automatic mechanisms or manually through one of the procedures explained in this FRG), the capacitors will begin to gradually discharge. After 5 minutes, the voltage level will have dropped below 60V, and **complete discharge requires approximately 10 minutes after high-voltage system shut down**. It is within this period of time that responders must be most cautious.

When arriving to an incident involving a Nissan LEAF, the vehicle should be approached with caution and inspected for the level of damage. In addition to overall vehicle condition (location and severity of body damage, air bag deployment, etc.), the high-voltage system should be assessed specifically. The locations of the high-voltage component parts are illustrated in this FRG. Refer to [2-1 High-Voltage-Related and 12-volt-Related Component Locations and Descriptions \(FRG-9\)](#). Appropriate Personal Protective Equipment (PPE) must always be worn when approaching a vehicle of unknown condition, as described in this FRG.

Situation 1) High-voltage system intact, occupants can be accessed without extrication tools

The HV system can be shut down by following the procedures in this guide, while wearing appropriate PPE. After HV system shut down, occupant assistance can begin immediately, and no wait period is necessary.

Situation 2) High-voltage system intact, occupants cannot be accessed without extrication tools

The HV system can be shut down by following the procedure in this guide, while wearing appropriate PPE. After HV system shut down, absolute care must be taken not to cut through or damage any HV system wiring, battery or components within **ten (10) minutes of HV system shut down**, but occupant assistance operations using extrication equipment can begin immediately. The locations of the HV components are illustrated in this guide.

Situation 3) High-voltage (HV) system damaged

If there is any evidence that the HV system has been compromised (such as arcing/sparking, orange wiring harnesses cut or damaged, HV component casings damaged, etc.), the responder may still be at risk of high-voltage exposure. The vehicle must be approached with extreme caution prior to initiating any system shut down procedures or rendering assistance to occupants. Appropriate PPE must always be worn as described in this guide, and the **ten (10) minute wait time must be observed after HV system shut down** in order to ensure the system is de-energized.



In rare situations where vehicle damage is very severe, HV system shut down procedures as described in this guide may not work. In these instances extreme caution and appropriate risk management must be followed to prevent shock or electrocution to the responder or occupant.

3-3.1 High-voltage System Shut-Down Procedures

Any of the following procedures can shut down and isolate the high-voltage system. The first response operation should only begin after shutting down the high-voltage system. If the vehicle is heavily damaged, for example the high-voltage battery is deformed, broken or cracked, appropriate Personal Protective Equipment (PPE) must always be used and the high-voltage battery and high-voltage components must not be touched.



⚠ DANGER

-  **Failure to properly shut down the high-voltage system before the Emergency Response Procedures are performed will result in serious injury or death from electrical shock. To prevent serious injury or death, NEVER touch high-voltage harnesses or components without always wearing appropriate Personal Protective Equipment (PPE). PPE must always be worn when touching or working on high-voltage components.**
-  **When contact with high-voltage components or high-voltage harnesses is unavoidable, or when there is risk of such contact, you must always wear appropriate PPE. PPE must always be worn when touching or working on high-voltage components.**

⚠ WARNING

- **⚠** If the charge connector is connected to the vehicle, remove it. Refer to [Removing the Charge Connector \(FRG-21\)](#).
- **⚠** The vehicle contains parts that contain powerful magnets. If a person who is wearing a pacemaker or other medical device is close to these parts, the medical device may be affected by the magnets. Such persons must not perform work on the vehicle.
- Be sure to verify that the READY  indicator is off and the high-voltage system is stopped.
- After the high-voltage system is shut down, please wait at least ten (10) minutes for complete discharge of the high-voltage capacitor. While waiting, do not operate any vehicle functions.

NOTE:

The high-voltage full discharge takes ten (10) minutes, but after five (5) minutes the voltage has dropped below 60V.

- After shutting down the high-voltage system and removing the 12-volt battery negative (-) terminal, wait at least three (3) minutes to discharge the air bag capacitor. Even though the 12-volt battery negative (-) is disconnected, the Supplemental Restraint System (SRS) air bag maintains voltage at least three (3) minutes. During this time, there is a possibility of sudden SRS air bag inflation due to harness short circuit or damage and it may cause serious injuries.
- Always shut down the high-voltage system before disconnecting the 12-volt battery. Not doing so may result in serious injury or death from electrical shock.
- The 12V system will remain active even after the 12-volt battery negative (-) terminal is removed while the high-voltage system is active. The high-voltage system is active during any of the following conditions:
 - charging indicator is turned ON
 - READY indicator is turned ONRefer to [1-1.2 Interior Component Location \(FRG-6\)](#) for location of these indicators. This is because DC/DC converter will not shut down and power will be supplied to the 12V system and high-voltage system continuously.

Removing the Charge Connector

NOTE:

Use the illustration to identify the type of charge connector and follow the appropriate procedure.

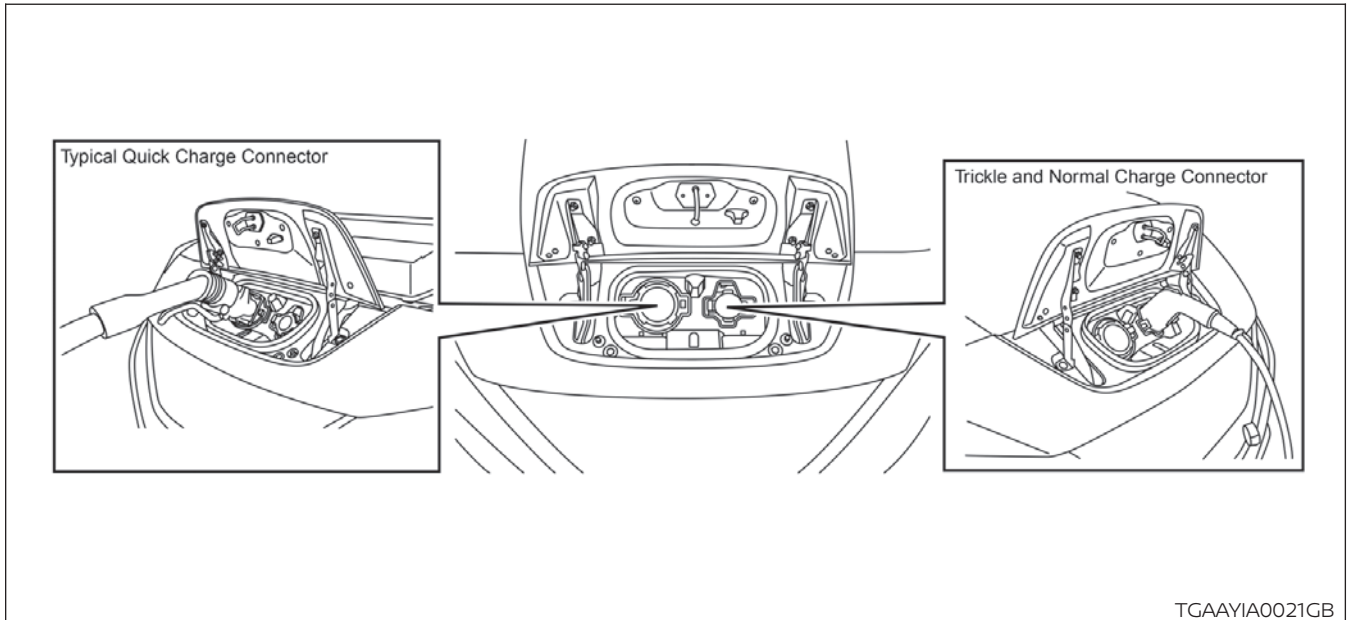

1. Quick Charge Connector (If So Equipped)

NOTE:

The quick charger must be OFF to release the charge connector lock.

Release the quick connector lock and pull to remove. Refer to the quick charger label or instructions.

2. Trickle and Normal Charge Connectors

- a. Press the charge connector release button on the charge connector and pull to remove.

NOTE:

If the charge connector cannot be removed, the electric lock is engaged. Follow the next steps to disengage.

- b. To disengage the electric charge connector lock, push the charge port lid opener switch. The charge connector will temporarily unlock for 30 seconds.

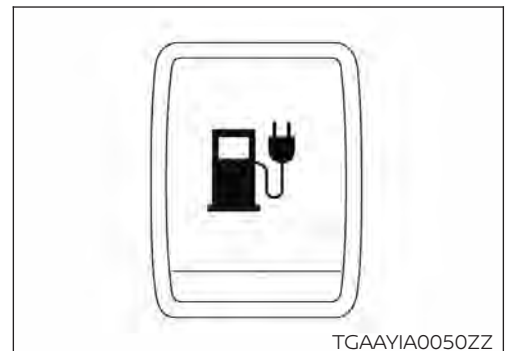

- c. The charge connector can be unlocked by pushing the charge connector unlock button on the Nissan Intelligent Key® for more than 1 second. The charge connector will temporarily unlock for 30 seconds.
- d. Press the charge connector release button and pull the charge connector to remove it.

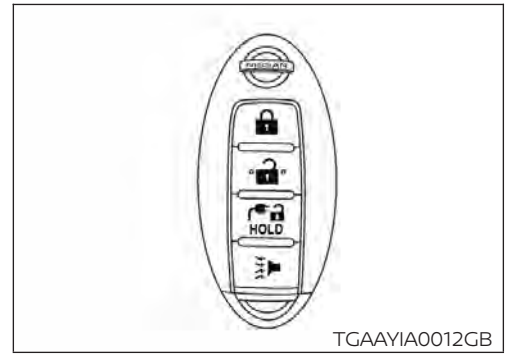

3. **If the Trickle or Normal Charge Connector Cannot Unlock**

- a. Place power switch in OFF position.

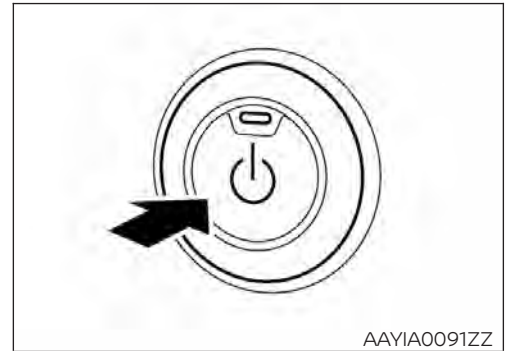

- b. Open the hood.

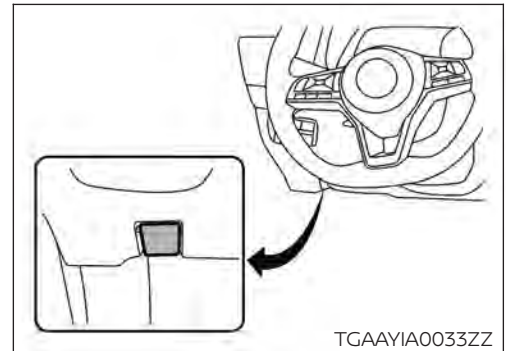

- c. Using a flat head screwdriver (or suitable tool), insert into the screw located through the access hole near the front of the hood lock.
- d. Rotate screw clockwise to release the charge connector lock.
- e. Press the charge connector release button and pull the charge connector to remove it.

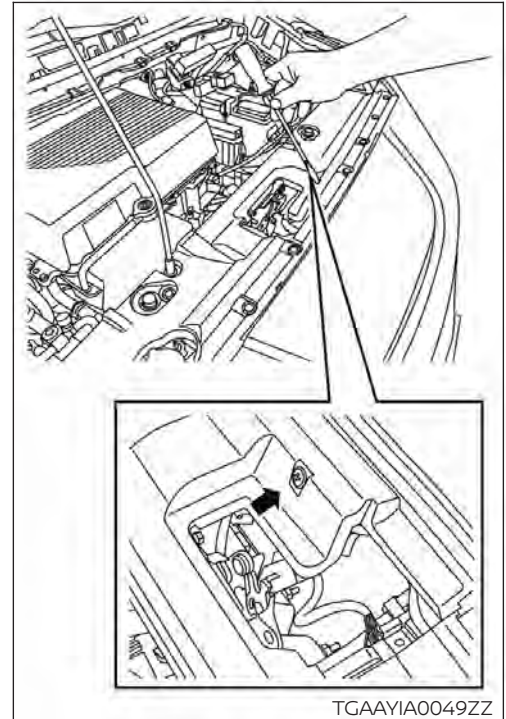

Indications the High-voltage System is ON

1. If the READY  indicator is ON, the high-voltage system is active.
2. The high-voltage system is active if any charge indicator is ON (blue LEDs on top of the instrument panel).

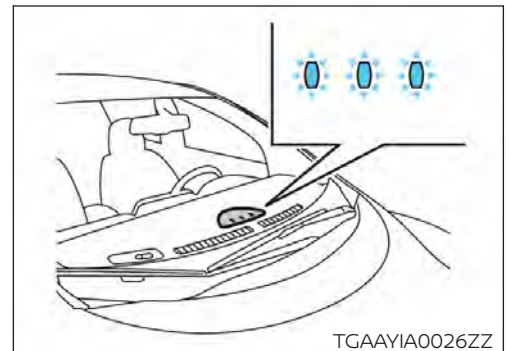



Before disconnecting the 12-volt battery terminal, if necessary, lower the windows, unlock the doors, and open the rear hatch as required. Once 12-volt battery is disconnected, power controls will not operate.

Powering Down the High-voltage System

The high-voltage system can be shut down with any 1 of the following procedures:

- Turn OFF the power switch **and** disconnect the 12-volt battery. Refer to [Primary Procedure \(FRG-24\)](#).
- Remove the fuses for the high-voltage control system and disconnect the 12-volt battery. Refer to [Alternate Procedure 1 \(Remove Fuses\) \(FRG-25\)](#).
- Remove the service plug and disconnect the 12-volt battery. Refer to [Alternate Procedure 2 \(Remove Service Plug\) \(FRG-27\)](#).

Primary Procedure

1. Check the READY  indicator status. If it is ON, the high-voltage system is active.
2. Place the selector lever in the Park (P) position.
3. Press the power switch once to turn OFF the high-voltage system. Then verify whether the READY  indicator is OFF and continue to the next steps to open the hood for 12-volt battery negative cable access.

If the READY indicator does not turn off, refer to [Alternate Procedure 1 \(Remove Fuses\) \(FRG-25\)](#).

4. If possible, keep the Nissan Intelligent Key® at least 5 meters (16 feet) away from the vehicle.

5. Open the hood.

6. Disconnect the negative (-) 12-volt battery cable (1). Insulate the negative (-) battery cable terminal with insulated tape.

NOTE:

 : Arrow in illustration depicts vehicle front direction.

7. **Wait at least ten (10) minutes for complete discharge** of the high-voltage capacitor after the power switch has been turned OFF.
8. Perform the first response action.

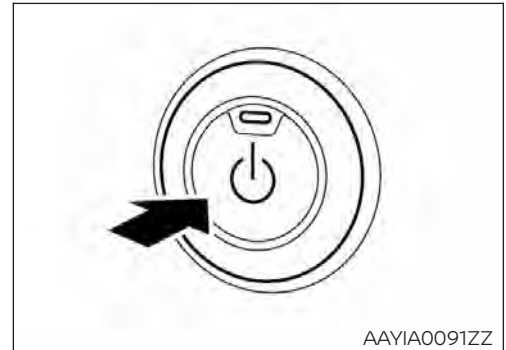

AAYIA0091ZZ

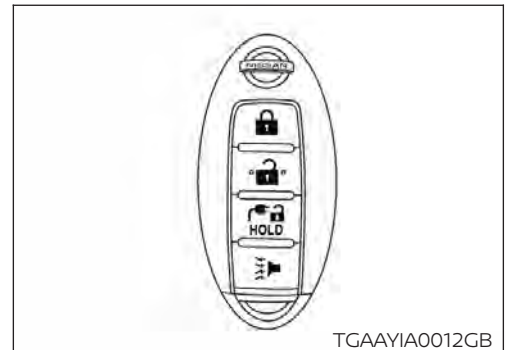

TGAAYIA0012GB

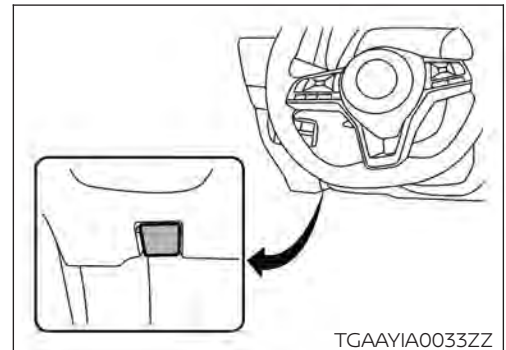

TGAAYIA0033ZZ

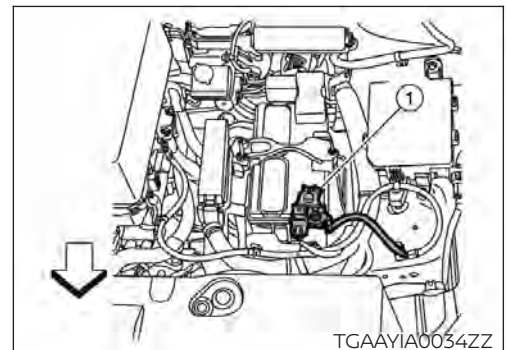

TGAAYIA0034ZZ

Alternate Procedure 1 (Remove Fuses)

1. Open the hood.

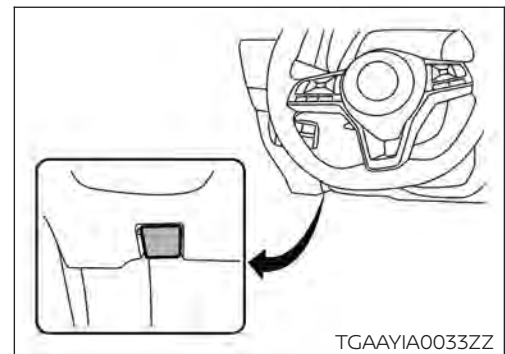

2. Press and expand the pawls (**A**) on the sides of the fuse box and remove the fuse box (**1**) from its housing.

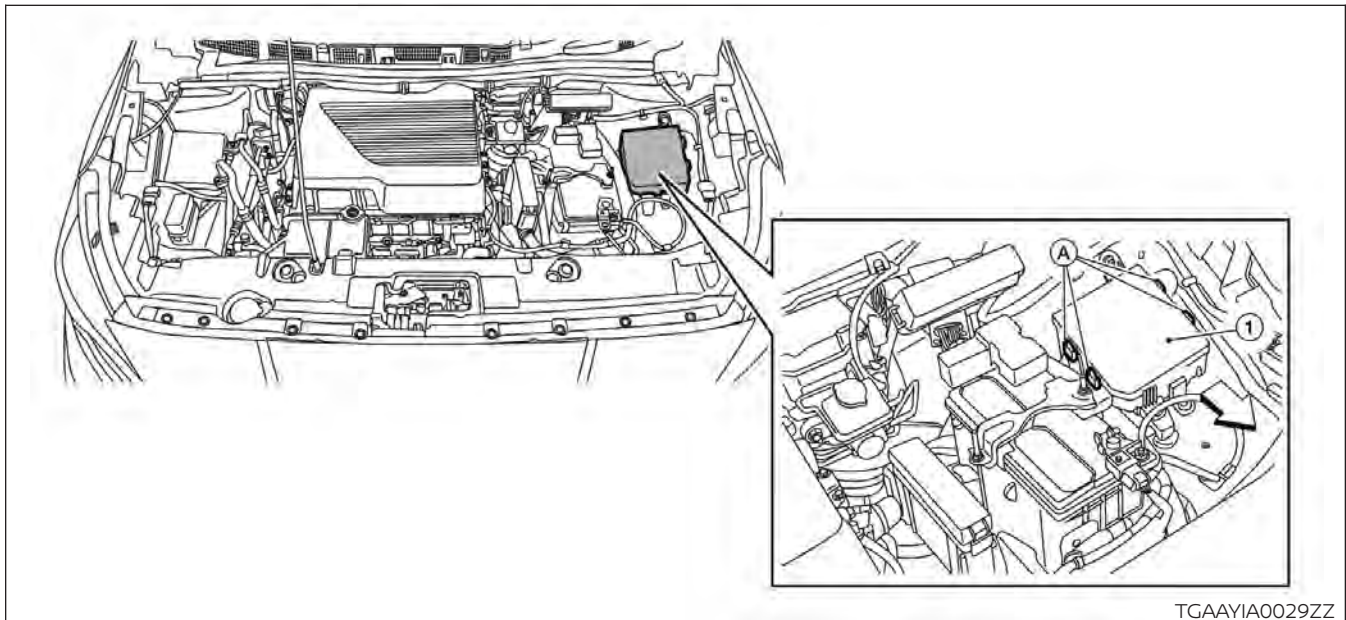

NOTE:

↩ : Arrow in illustration depicts vehicle front direction.

NOTE:

There is no separate fuse box cover. The bottom of the fuse box is also its cover.

3. Remove F/S1 RLY Fuse (F24 F/S1 RLY 15A).

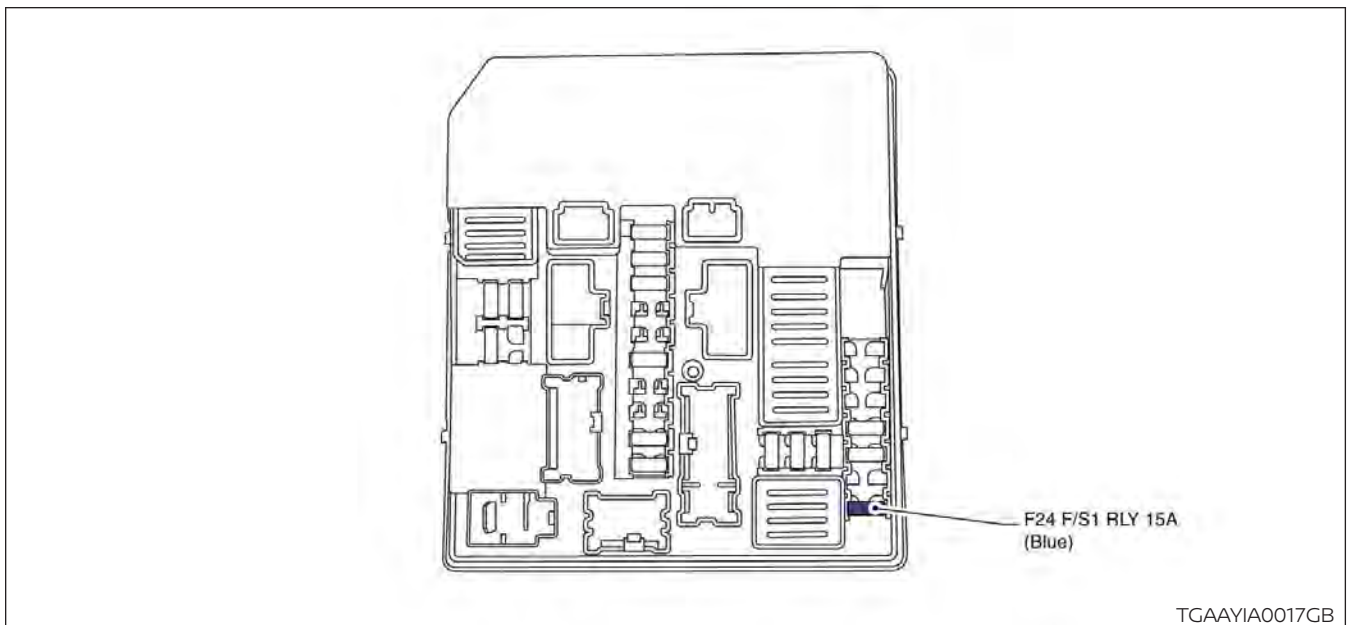

4. If you cannot identify the above fuse, remove all fuses in the fuse boxes.
5. Disconnect the negative (-) 12-volt battery cable (1). Insulate the negative (-) battery cable terminal with insulated tape.

NOTE:

← : Arrow in illustration depicts vehicle front direction.

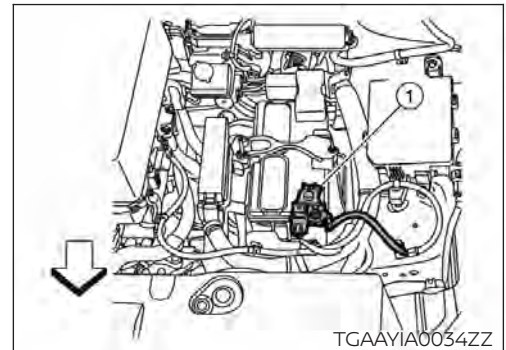

6. **Wait at least ten (10) minutes for complete discharge** of the high-voltage capacitor after the fuses are pulled.
7. Perform the first response action.



⚠ WARNING

⚠ To avoid unintended reinstallation and risk of electrical shock and severe personal injury or death, the rescuer should carry the fuses on his/her person and cover the fuse box with insulated tape.

Alternate Procedure 2 (Remove Service Plug)



DANGER

-  Do not remove the service plug without always wearing appropriate Personal Protective Equipment (PPE) to help protect the responder from serious injury or death by electrical shock.
-  Immediately cover the service plug socket with insulated tape. The high-voltage battery retains high-voltage power even when the service plug is removed. To avoid electric shock, NEVER touch the terminals inside the socket.

WARNING

 To avoid unintended reinstallation and risk of electrical shock and severe personal injury or death, the rescuer should carry the service plug on his/her person while work is in progress.

1. Insert a suitable tool (1) under the RH rear corner of the access trim cover located on the floor behind the center console. Pry up (2) and remove.

NOTE:

 : Arrow in illustration depicts vehicle front direction.

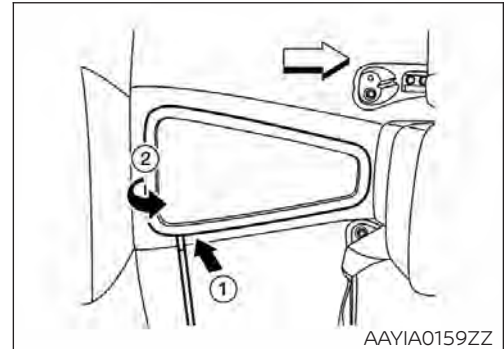

2. Remove the 10 mm access cover bolts (1) and remove the cover (2).

NOTE:

 : Arrow in illustration depicts vehicle front direction.

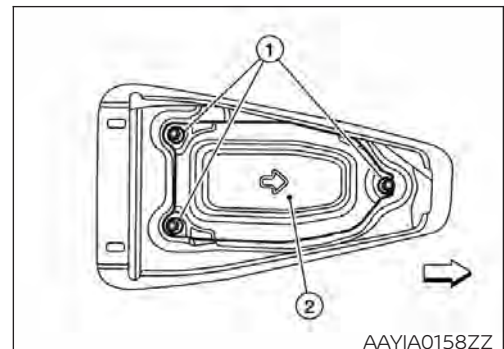

- Remove the service plug using the following steps: **(1)** pull up and release the green lever, **(2)** press the locking tab to release and rotate fully upward, **(3)** pull the service plug completely out of its socket.

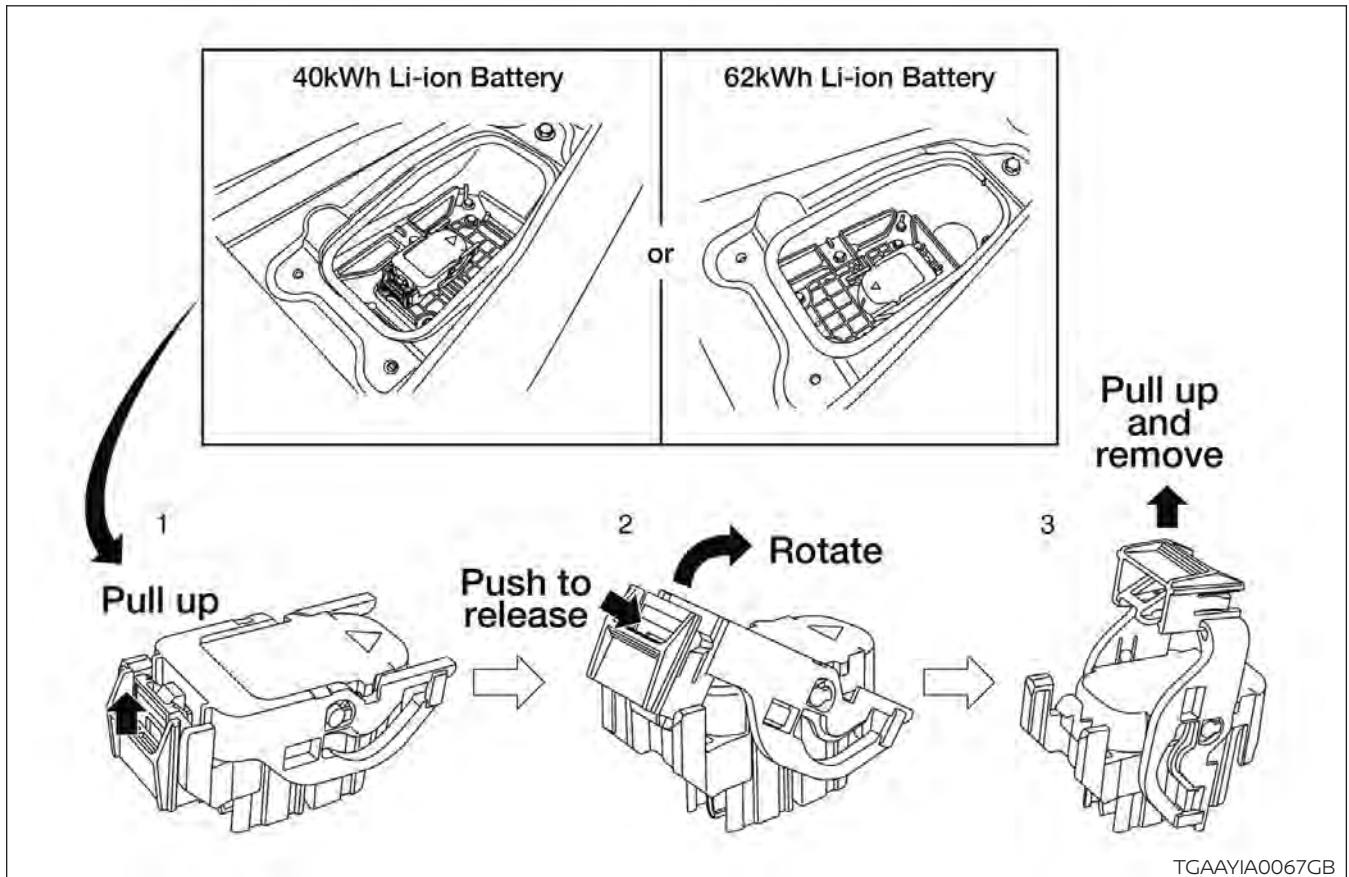

- Wait at least (10) minutes for complete discharge** of the high-voltage capacitor after the service plug has been removed.
- Open the hood.

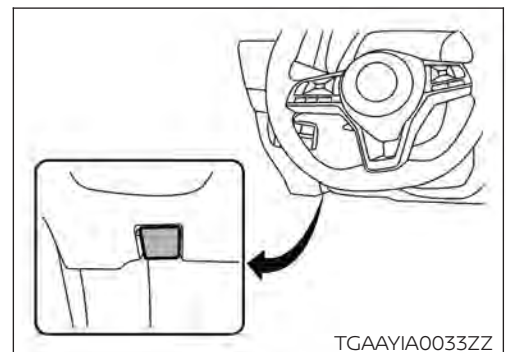

- Disconnect the negative (-) 12-volt battery cable **(1)**. Insulate the negative (-) battery cable terminal with insulated tape.

NOTE:

↔ : **Arrow in illustration depicts vehicle front direction.**

- Perform the first response action.

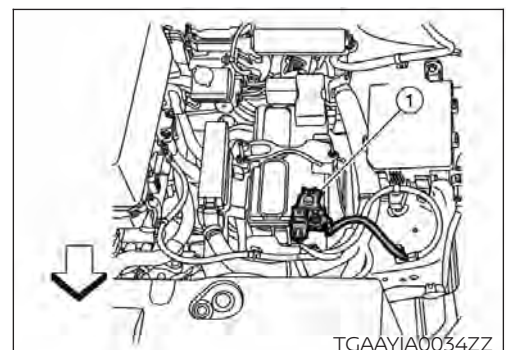

3-3.2 Water Submersion





DANGER



Damage level of submerged vehicle may not be apparent. Handling a submerged vehicle without appropriate Personal Protective Equipment (PPE) will result in serious injury or death from electrical shock.

WARNING

-  The power switch of the submerged vehicle must be turned OFF first, if possible. Then the vehicle must be completely out of the water and drained to avoid electrical shock.
-  Always wear appropriate Personal Protective Equipment (PPE) and remove/drain water before removing the service plug when working on a vehicle after a fire or submersion to avoid electrical shock.
-  If the vehicle is in the water, to avoid electrical shock NEVER touch the high-voltage components, harnesses or service plug. PPE must always be worn when touching or working on high-voltage components.

3-3.3 Vehicle Fire

WARNING

- Always utilize full Personal Protective Equipment (PPE) and self-contained breathing apparatus during fire fighting operations. Smoke from a LEAF vehicle fire is similar to smoke from a conventional vehicle fire.
- In the case of extinguishing a fire with water, large amounts of water from a fire hydrant (if possible) must be used. DO NOT extinguish fire with a small amount of water.

CAUTION

In the event of a small fire, a Type ABC fire extinguisher may be used for an electrical fire caused by wiring harnesses, electrical components, etc. or oil fire.

Fire attack should follow standard fire fighting practices.



If you must walk away from the vehicle, notify an appropriate responder or a rescue person of the fact that the vehicle is an electric car and contains a high-voltage system and warn all others.

During overhaul operations (late stage fire suppression process to examine for remaining sources of heat), make sure the battery is fully cooled to avoid fire re-ignition. The battery could reignite if it is placed near fire. To avoid possible electrical shock and serious personal injury, do not breach the high-voltage battery case.

3-3.4 Cutting the Vehicle Body



DANGER

-  Do not cut into high-voltage related areas to avoid severe personal injury or death.
-  Do not cut into the high-voltage battery to avoid severe personal injury or death.
-  When removing parts, **NEVER** touch the high-voltage parts or the insides of the exposed orange-colored high-voltage cables to avoid severe personal injury or death. Personal Protective Equipment (PPE) must always be worn when touching or working on high-voltage components.

WARNING

- Do not cut air bag parts to avoid unintended deployment of the air bags and the risk of severe personal injury or death.

If at least **ten (10) minutes** have passed since the rescuer shut down the high-voltage system (refer to [3-3.1 High-voltage System Shut-Down Procedures \(FRG-19\)](#)), then the rescuer can cut the vehicle except for the high-voltage battery.

If the rescuer cannot wait the full ten (10) minutes or shut down the high-voltage system, absolute care must be taken to avoid cutting HV parts and appropriate Personal Protective Equipment (PPE) must always be worn. DO NOT cut the high-voltage battery due to possible electrocution risk and electrolyte solution leakage.

SRS Air Bag System Components Location

Avoid cutting air bag system parts. However, the vehicle can be cut (except inflators) under the following conditions:

- The front, side and curtain air bags have deployed.
- At least three (3) minutes have passed after the 12-volt battery negative (-) cable has been disconnected and the high-voltage system has been shut down.

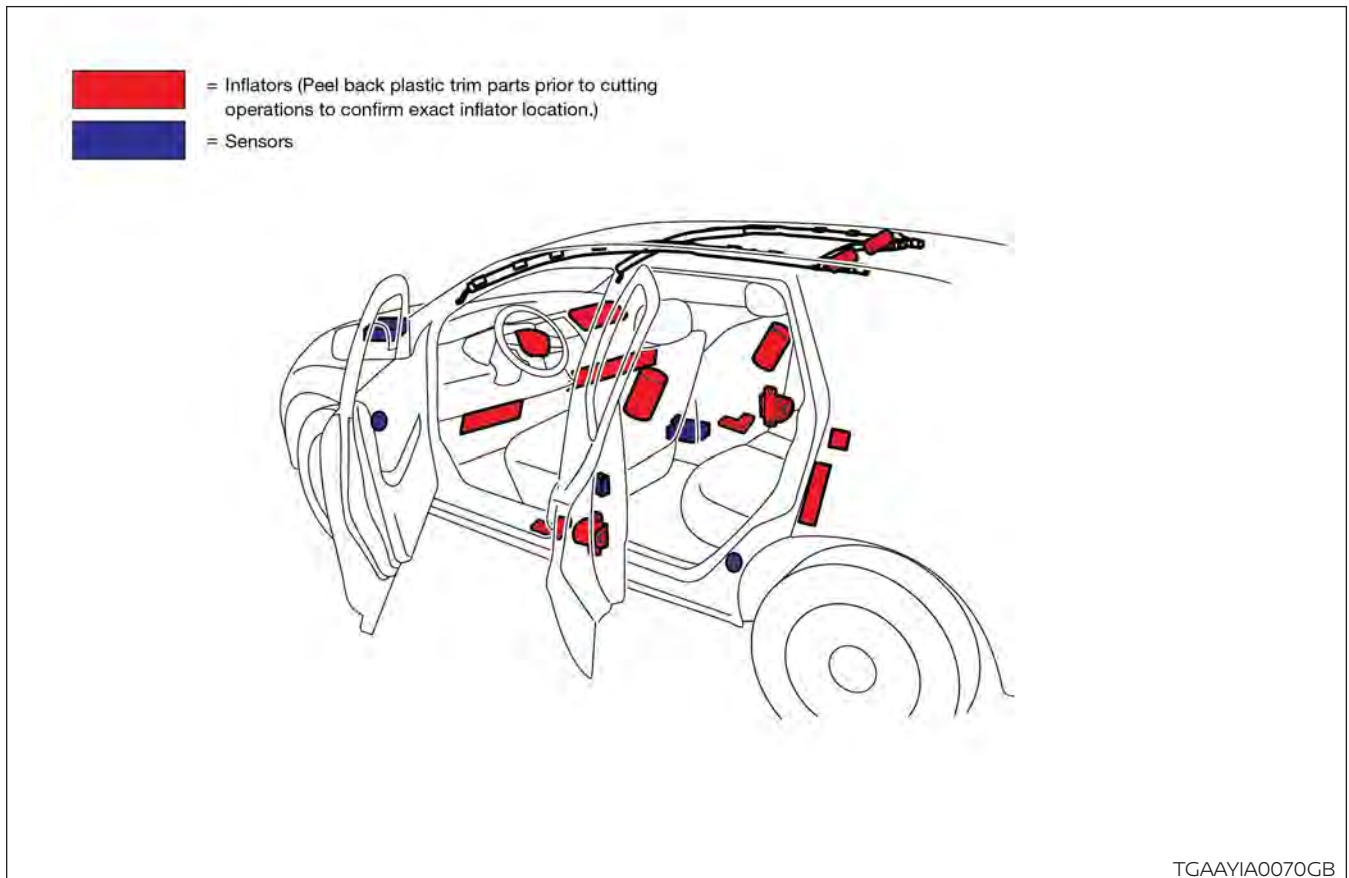

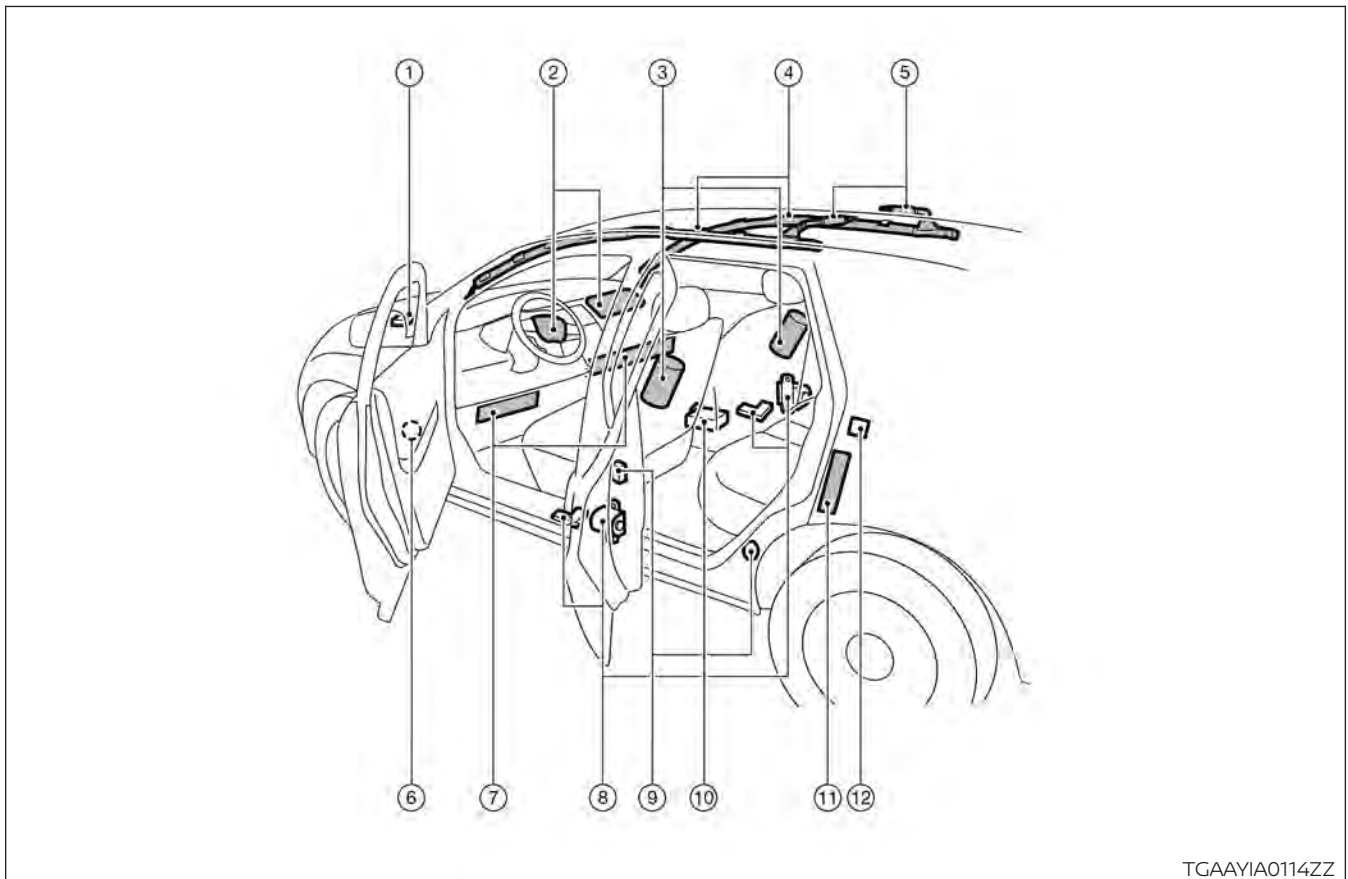

TGAAYIA0114ZZ

1. Crash zone sensor

2. Supplemental front-impact air bag modules

3. Front seat-mounted side-impact supplemental air bag modules

4. Roof-mounted curtain side-impact and rollover supplemental air bag modules

5. Roof-mounted curtain side-impact and rollover supplemental air bag inflators

6. Front door satellite sensors

7. Driver and passenger supplemental knee air bag modules

8. Seat belts with pretensioners (front seats)

9. Rear satellite sensors (located in lower B-pillars and C-pillars) (driver's side shown; passenger's side similar)

10. Air bag control unit (ACU)

11. Rear outboard seat-mounted side impact supplemental air bag modules (driver's side shown; passenger's side similar)

12. Seat belt with pretensioner (rear outboard seats) (driver's side shown; passenger's side similar)

Emergency Contact:
 Nissan EV Customer Support: 1-877-664-2738 or
 Nissan Consumer Affairs: 1-800-647-7261 (US) or 1-800-387-0122 (Canada)

Underside View Shown

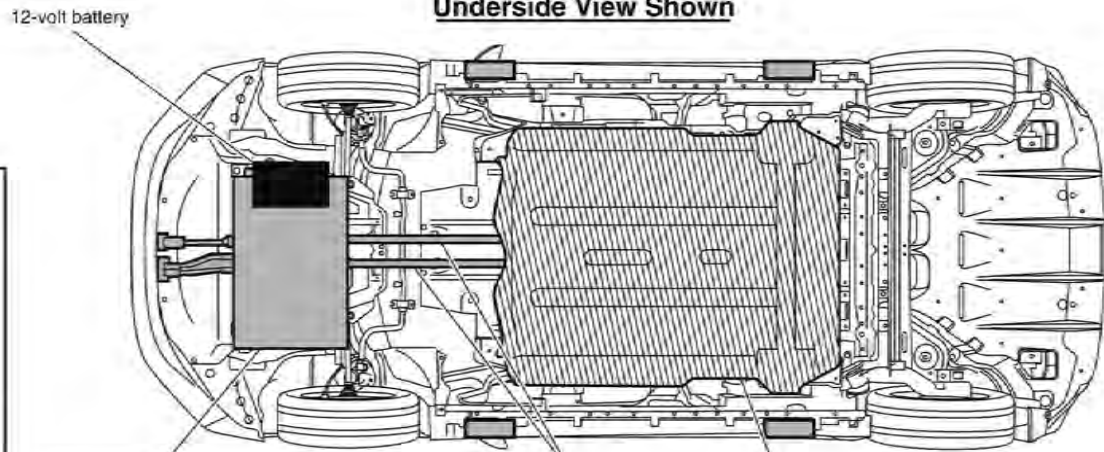

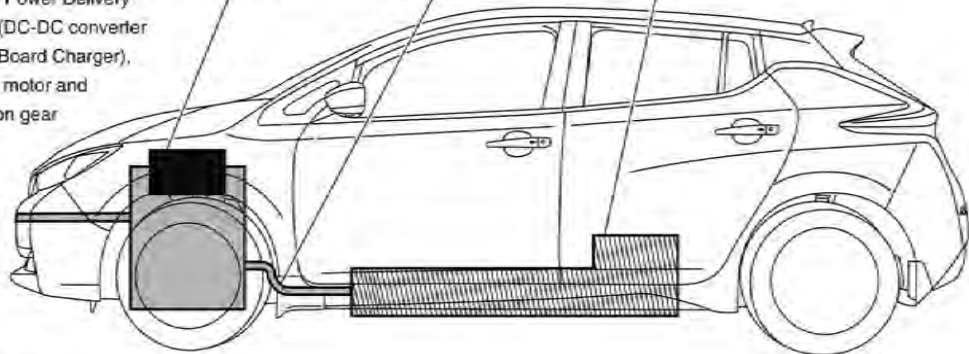

High-voltage components:
 Inverter, Power Delivery
 Module (DC-DC converter
 and On Board Charger),
 Traction motor and
 Reduction gear

12-volt battery High-voltage harness High-voltage battery



Key

 High-voltage component or harness
 (Harness can be cut only after the high-voltage system shut down procedure has been completed.)

 NEVER CUT-
 High-voltage battery

 12-volt Battery



Never cut high-voltage components/batteries identified as "NEVER CUT" for any reason. Death or serious personal injury will result.

Nissan North America, Inc. Version 7, May 2019

TCAAVIA0068GB

High Strength Steel Locations

-  = High strength steel
-  =  **DANGER**

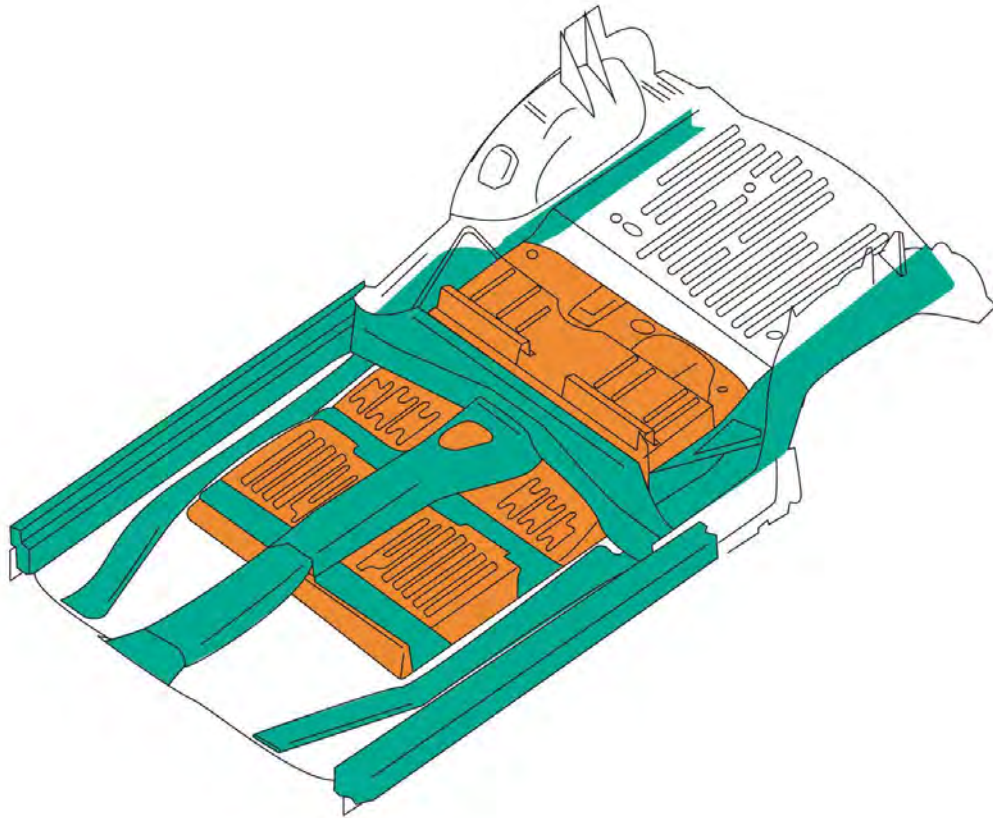
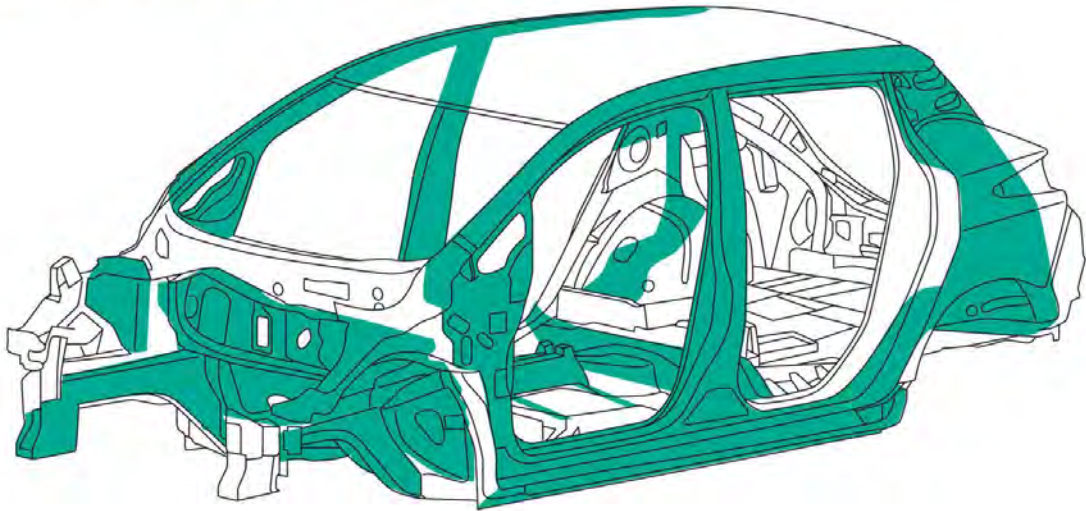

TGAAYIA0032GB

3-3.5 High-voltage Battery Damage and Fluid Leaks

⚠ WARNING

The high-voltage battery contains electrolyte solution. To avoid exposure to electrolyte solution and serious personal injury, always wear appropriate solvent resistant Personal Protective Equipment (PPE) and read the following precautions:

- Electrolyte solution is a skin irritant – If contact with skin, rinse with plenty of water and see a doctor immediately.
- Electrolyte solution is an eye irritant – If contact with eyes, rinse with plenty of water and see a doctor immediately.
- If electrolyte leak occurs, wear appropriate solvent resistant PPE and use a dry cloth to clean up the spilled electrolyte. Be sure to adequately ventilate the area.
- Electrolyte solution is highly flammable.
- Electrolyte liquid or fumes that have come into contact with water vapors in the air will create an oxidized substance. This substance may irritate skin and eyes. In these cases, rinse with plenty of water and see a doctor immediately.
- Electrolyte fumes (when inhaled) can cause respiratory irritation and acute intoxication. Move to fresh air and wash mouth with water. See a doctor immediately.

If electrolyte solution leakage, or damage such as any problem with the high-voltage battery casing are observed, first responders should attempt to neutralize the battery by applying a large volume of water to the battery pack while wearing appropriate Personal Protective Equipment (PPE). The neutralization process helps stabilize the thermal condition of the battery pack but does not discharge the battery.

High-voltage Battery Electrolyte Solution Characteristics:

- Clear in color
- Sweet odor
- Similar viscosity to water
- Since the high-voltage battery is made up of many small sealed battery modules, electrolyte solution leakage should be minimal.

NOTE:

Other fluids in the vehicle are the same as those in a conventional internal combustion vehicle.

3-3.6 Accessing the Occupants

1. Remove windows.
 - a. Perform window removal the same as a normal vehicle.
2. Remove doors.
 - a. The doors are removable with hand tools or basic rescue tools such as electrical/hydraulic rescue tools. It may be easier to remove the doors by cutting door hinges.
3. Adjust steering wheel and front seat position (if necessary).
 - a. To adjust steering wheel, push the lock lever down (1) and adjust the steering wheel up or down, forward or rearward (2).

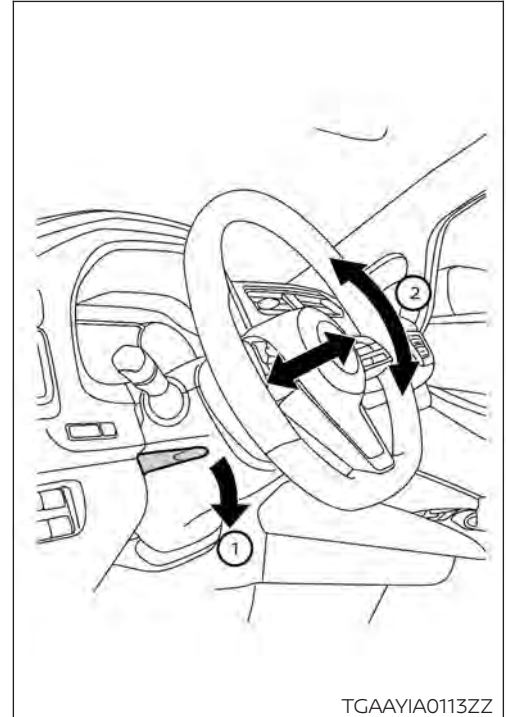

- b. Manual front seat can be adjusted forward/backward by pulling up and holding lever (1) and tilted forward/backward by pulling up and holding lever (2).

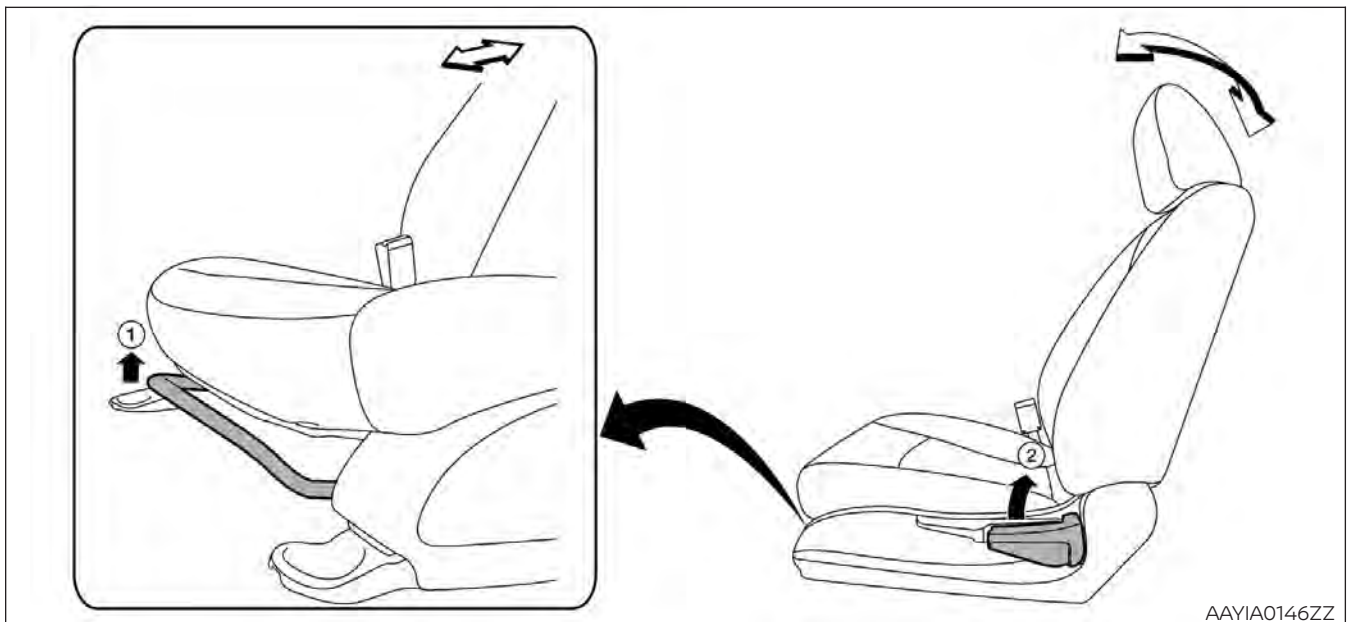

- c. Power front seat can be adjusted as shown.

NOTE:

Before disconnecting the 12-volt battery terminal, if necessary, lower the windows, adjust the driver power seat, unlock the doors, etc. Once 12-volt battery is disconnected, power controls will not operate.

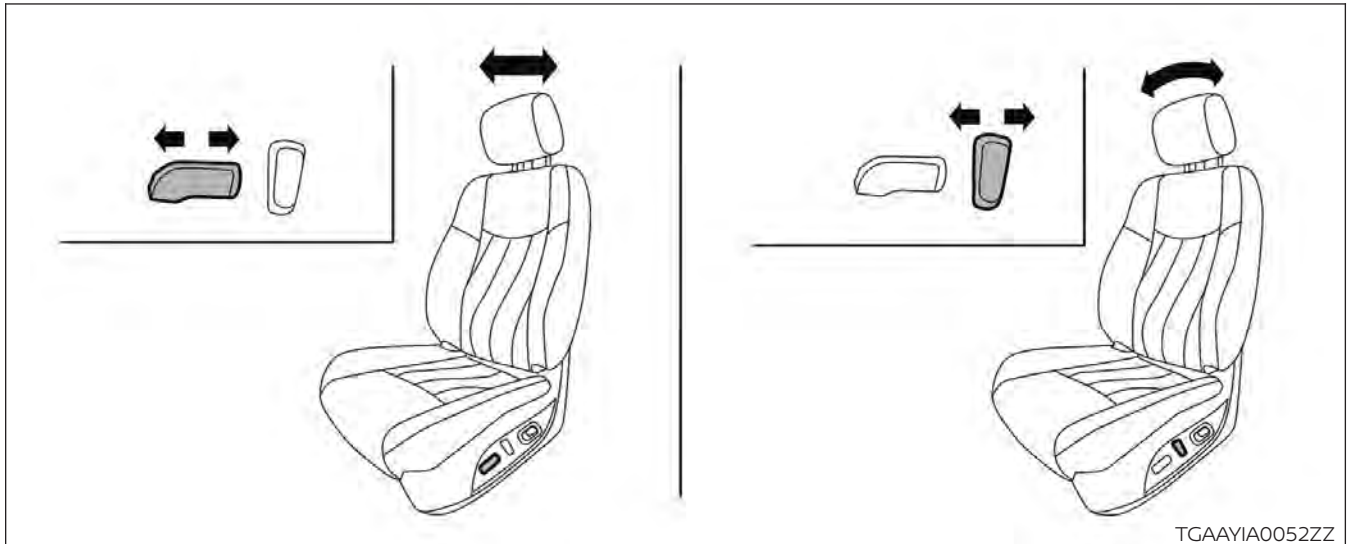

4. Remove front seat head restraint (if necessary).

The front seat head restraint can be removed by pressing the lock knob and pulling it up.

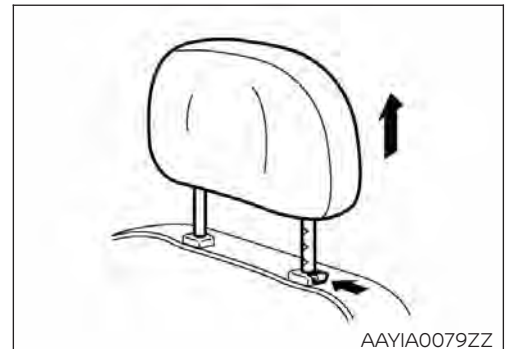

5. Unfasten the seat belt.

Seat belt can be unfastened by pressing the release button. If seat belt cannot be unfastened, cut it with a belt cutter.

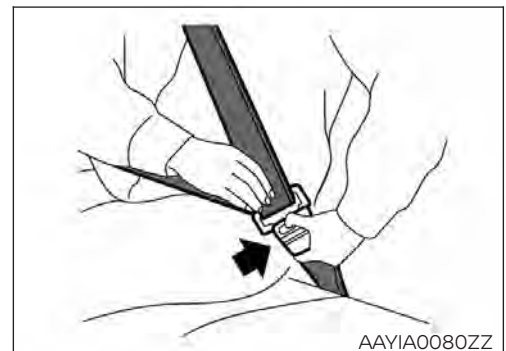

3-4 Storing The Vehicle

For vehicle storage information, refer to Roadside Assistance Guide or Dismantling Guide located at www.nissanusa.com or www.nissan-techinfo.com.

4. Emergency Quick Reference Guide

The following is for emergency quick reference only. It does not replace the detailed safety information and procedures in this manual.

2022 NISSAN LEAF®

Emergency Responder's Quick Reference Guide

The following is for emergency quick reference only. It does not replace the detailed safety information and procedures in the First Responder's Guide (FRG).

VEHICLE IDENTIFICATION

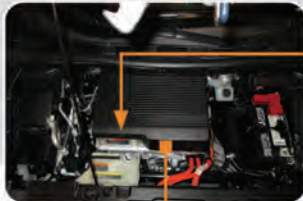

**⚡ WARNING / AVERTISSEMENT
ACHTUNG / ADVERTENCIA / AVISO**

HIGH VOLTAGE INSIDE
 • DO NOT remove these covers and/or connectors.
HOCHSPANNUNGSFÜHRENDE TEILE IM INNEREN
 • Diese Abdeckungen bzw. Stecker nicht entfernen.
HAUTE TENSION À L'INTÉRIEUR
 • NE PAS enlever ces couvercles et connecteurs.
Alta Voltagem no Interior
 • Nunca remova esta cobertura e/ou conector.
Alto voltaje en el interior
 • Nunca remueva esta tapa y/o conector.



NO TAIL PIPE

WARNING AND INDICATOR LAMPS

LAMP NAME	ICON	DESCRIPTION
READY Indicator		This lamp is on when the EV system is powered up and the vehicle is ready to drive.
EV System Warning Lamp *1		This lamp is on when: <ul style="list-style-type: none"> Malfunction has occurred in the EV system and/or Emergency shut-off system has been activated. The shut-off system activates in the following conditions: <ul style="list-style-type: none"> Front and side collisions in which the air bags are deployed. Certain rear collisions. Certain EV system malfunctions.
Master Warning Lamp (RED)		This lamp is on when another red warning lamp is displayed in the instrument cluster or a warning is displayed in the vehicle information display.
Master Warning Lamp (YELLOW)		This lamp is on when: <ul style="list-style-type: none"> High-voltage battery is getting low on charge. Another yellow warning lamp is displayed in the instrument cluster or a message is displayed in the vehicle information display.

*1: The READY indicator light will turn off in certain EV system malfunctions.

HIGH-VOLTAGE (HV) PARTS LOCATIONS

= **⚠ DANGER**

DO NOT CUT HV PARTS!

Emergency Responder's Quick Reference Guide

The following is for emergency quick reference only. It does not replace the detailed safety information and procedures in the First Responder's Guide (FRG).

VEHICLE SHUT-DOWN

Appropriate Personal Protective Equipment (PPE) must always be worn during these procedures and while working on or near high-voltage components, battery or harnesses!

PRIMARY PROCEDURE

1.

Turn Power Switch OFF



2.

Verify READY indicator is OFF



3.

If possible, keep the Nissan Intelligent Key® at least 5 meters (16 feet) away



4.

Open hood and remove Negative Battery Cable



ALTERNATE PROCEDURE 1.

1.

Open hood and remove Fuse

Release four tabs to remove fuse panel.



2.

Remove Negative Battery Cable

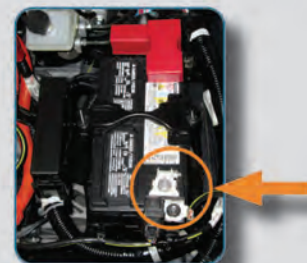

2022 NISSAN LEAF®

Emergency Responder's Quick Reference Guide

The following is for emergency quick reference only. It does not replace the detailed safety information and procedures in the First Responder's Guide (FRG).

ALTERNATE PROCEDURE 2.

1.

Remove Service Plug

40kWh Li-ion Battery

62kWh Li-ion Battery



OR



Located under access panel behind center console. After removal, wait 10 minutes for the HV system to fully discharge. If unable to wait full 10 minutes, absolute care must be taken and full Personal Protective Equipment (PPE) must be worn.

A Pull up



B Push in



C Rotate

D Pull out

2.

Remove Negative Battery Cable



HIGH-VOLTAGE SYSTEM SHUT DOWN AND VEHICLE DAMAGE LEVEL CONSIDERATIONS

Note: If any air bags have deployed in the following 3 situations, the high-voltage (HV) system has been designed to automatically shut off at the time of deployment.

1) High-voltage (HV) system intact, occupants can be accessed without extrication tools

The HV system can be shut down by following the procedure in this QRG, while wearing appropriate Personal Protective Equipment (PPE). After HV system shut down, occupant assistance operations can begin immediately, and no wait period is necessary.

(2) High-voltage (HV) system intact, occupants cannot be accessed without extrication tools

The HV system can be shut down by following the procedure in this QRG, while wearing appropriate Personal Protective Equipment (PPE). After HV system shut down, absolute care must be taken not to cut through or damage any HV system wiring, battery or components within 10 minutes of HV system shut down, but occupant assistance operations using extrication equipment can begin immediately. The locations of the HV component parts are illustrated in this QRG.

(3) High-voltage (HV) system damaged

If there is any evidence that the HV system has been compromised (such as arcing/sparking, orange wiring harnesses cut or damaged, HV component casings damaged, etc.), the responder may still be at risk of high-voltage exposure. The vehicle must be approached with extreme caution prior to initiating any system shut down procedures or rendering assistance to occupants. Appropriate Personal Protective Equipment (PPE) must always be worn as described in the FRG, and the 10 minute wait time must be observed after HV system shut down in order to ensure the system is de-energized.

In rare situations where vehicle damage is very severe, HV system shut down procedures as described in the FRG or this QRG may not work. In these instances extreme caution and appropriate risk management must be followed to prevent shock or electrocution to the responder or occupant.

2022 NISSAN LEAF®

Emergency Responder's Quick Reference Guide

The following is for emergency quick reference only. It does not replace the detailed safety information and procedures in the First Responder's Guide (FRG).

VEHICLE IDENTIFICATION

SRS AIR BAG SYSTEM PARTS LOCATIONS

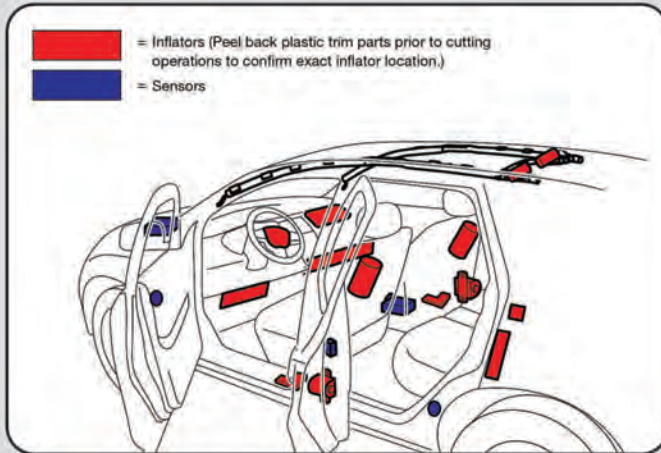

DO NOT CUT AIR BAG PARTS!

VEHICLE FIRE

- Use standard firefighting equipment.
- Use large amounts of water.
- Be sure high-voltage battery is completely extinguished and cooled to avoid reignition.

VEHICLE SUBMERSION

- Wear appropriate Personal Protective Equipment (PPE) before entering water.
- Vehicle must be removed from water and drained before touching any HV parts.

HIGH-VOLTAGE BATTERY ELECTROLYTE CHARACTERISTICS

- Clear in color.
- Sweet odor.
- Similar viscosity to water.
- Highly flammable.
- Skin and eye irritant – rinse with plenty of water and see a doctor immediately.
- Wear appropriate Personal Protective Equipment (PPE) around electrolyte leakage.

HIGH STRENGTH STEEL LOCATIONS

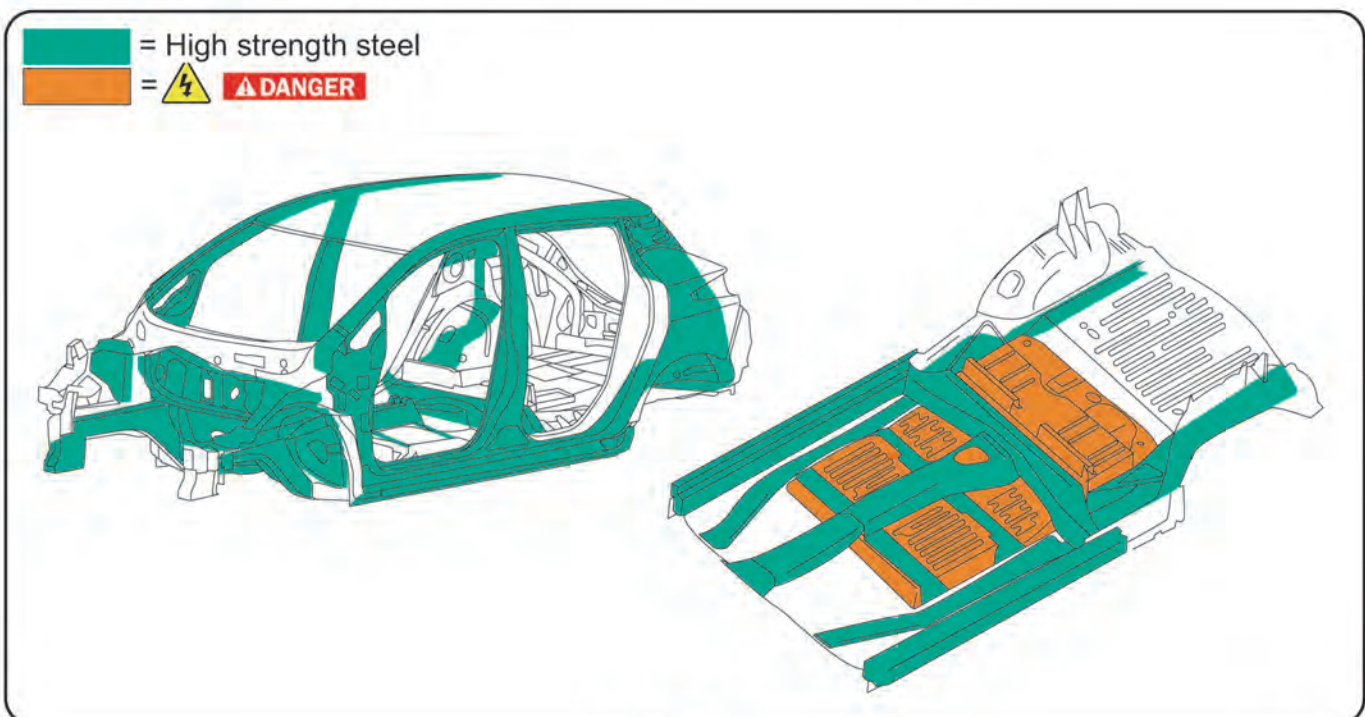



© 2021 Nissan North America, Inc.
All rights reserved.

This document may not be altered without the written permission of Nissan North America, Inc.
Pub. No. FR22EA0ZE1U0